

P-660R-D Series

ADSL2+ Router

User's Guide

Version 3.40

7/2006

Edition 1

The logo for ZyXEL, featuring the word "ZyXEL" in a bold, blue, sans-serif font. The "Zy" is lowercase and the "XEL" is uppercase. The letters are closely spaced and have a slight italicized appearance.

Copyright

Copyright © 2006 by ZyXEL Communications Corporation.

The contents of this publication may not be reproduced in any part or as a whole, transcribed, stored in a retrieval system, translated into any language, or transmitted in any form or by any means, electronic, mechanical, magnetic, optical, chemical, photocopying, manual, or otherwise, without the prior written permission of ZyXEL Communications Corporation.

Published by ZyXEL Communications Corporation. All rights reserved.

Disclaimer

ZyXEL does not assume any liability arising out of the application or use of any products, or software described herein. Neither does it convey any license under its patent rights nor the patent rights of others. ZyXEL further reserves the right to make changes in any products described herein without notice. This publication is subject to change without notice.

Trademarks

ZyNOS (ZyXEL Network Operating System) is a registered trademark of ZyXEL Communications, Inc. Other trademarks mentioned in this publication are used for identification purposes only and may be properties of their respective owners.

Certifications

Federal Communications Commission (FCC) Interference Statement

This device complies with Part 15 of FCC rules. Operation is subject to the following two conditions:

- This device may not cause harmful interference.
- This device must accept any interference received, including interference that may cause undesired operations.

This equipment has been tested and found to comply with the limits for a Class B digital device pursuant to Part 15 of the FCC Rules. These limits are designed to provide reasonable protection against harmful interference in a residential installation. This equipment generates, uses, and can radiate radio frequency energy, and if not installed and used in accordance with the instructions, may cause harmful interference to radio communications. However, there is no guarantee that interference will not occur in a particular installation

If this equipment does cause harmful interference to radio/television reception, which can be determined by turning the equipment off and on, the user is encouraged to try to correct the interference by one or more of the following measures:

- Reorient or relocate the receiving antenna.
- Increase the separation between the equipment and the receiver.
- Connect the equipment into an outlet on a circuit different from that to which the receiver is connected.
- Consult the dealer or an experienced radio/TV technician for help.

Notice 1

Changes or modifications not expressly approved by the party responsible for compliance could void the user's authority to operate the equipment.

This Class B digital apparatus complies with Canadian ICES-003.

Cet appareil numérique de la classe B est conforme à la norme NMB-003 du Canada.

FCC Caution

Any changes or modifications not expressly approved by the party responsible for compliance could void the user's authority to operate this equipment.

Viewing Certifications

- 1 Go to www.zyxel.com

- 2** Select your product from the drop-down list box on the ZyXEL home page to go to that product's page.
- 3** Select the certification you wish to view from this page.

Safety Warnings

For your safety, be sure to read and follow all warning notices and instructions.

- To reduce the risk of fire, use only No. 26 AWG (American Wire Gauge) or larger telecommunication line cord.
- Do NOT open the device or unit. Opening or removing covers can expose you to dangerous high voltage points or other risks. ONLY qualified service personnel can service the device. Please contact your vendor for further information.
- Use ONLY the dedicated power supply for your device. Connect the power cord or power adaptor to the right supply voltage (110V AC in North America or 230V AC in Europe).
- Do NOT use the device if the power supply is damaged as it might cause electrocution.
- If the power supply is damaged, remove it from the power outlet.
- Do NOT attempt to repair the power supply. Contact your local vendor to order a new power supply.
- Place connecting cables carefully so that no one will step on them or stumble over them. Do NOT allow anything to rest on the power cord and do NOT locate the product where anyone can walk on the power cord.
- If you wall mount your device, make sure that no electrical, gas or water pipes will be damaged.
- Do NOT install nor use your device during a thunderstorm. There may be a remote risk of electric shock from lightning.
- Do NOT expose your device to dampness, dust or corrosive liquids.
- Do NOT use this product near water, for example, in a wet basement or near a swimming pool.
- Make sure to connect the cables to the correct ports.
- Do NOT obstruct the device ventilation slots, as insufficient airflow may harm your device.
- Do NOT store things on the device.
- Connect ONLY suitable accessories to the device.

This product is recyclable. Dispose of it properly.

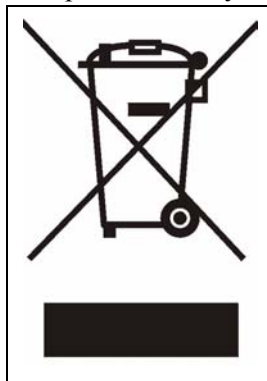

ZyXEL Limited Warranty

ZyXEL warrants to the original end user (purchaser) that this product is free from any defects in materials or workmanship for a period of up to two years from the date of purchase. During the warranty period, and upon proof of purchase, should the product have indications of failure due to faulty workmanship and/or materials, ZyXEL will, at its discretion, repair or replace the defective products or components without charge for either parts or labor, and to whatever extent it shall deem necessary to restore the product or components to proper operating condition. Any replacement will consist of a new or re-manufactured functionally equivalent product of equal or higher value, and will be solely at the discretion of ZyXEL. This warranty shall not apply if the product has been modified, misused, tampered with, damaged by an act of God, or subjected to abnormal working conditions.

Note

Repair or replacement, as provided under this warranty, is the exclusive remedy of the purchaser. This warranty is in lieu of all other warranties, express or implied, including any implied warranty of merchantability or fitness for a particular use or purpose. ZyXEL shall in no event be held liable for indirect or consequential damages of any kind to the purchaser.

To obtain the services of this warranty, contact ZyXEL's Service Center for your Return Material Authorization number (RMA). Products must be returned Postage Prepaid. It is recommended that the unit be insured when shipped. Any returned products without proof of purchase or those with an out-dated warranty will be repaired or replaced (at the discretion of ZyXEL) and the customer will be billed for parts and labor. All repaired or replaced products will be shipped by ZyXEL to the corresponding return address, Postage Paid. This warranty gives you specific legal rights, and you may also have other rights that vary from country to country.

Customer Support

Please have the following information ready when you contact customer support.

- Product model and serial number.
- Warranty Information.
- Date that you received your device.
- Brief description of the problem and the steps you took to solve it.

METHOD	SUPPORT E-MAIL	TELEPHONE	WEB SITE	REGULAR MAIL
LOCATION	SALES E-MAIL	FAX	FTP SITE	
CORPORATE HEADQUARTERS (WORLDWIDE)	support@zyxel.com.tw	+886-3-578-3942	www.zyxel.com www.europe.zyxel.com	ZyXEL Communications Corp. 6 Innovation Road II Science Park Hsinchu 300 Taiwan
	sales@zyxel.com.tw	+886-3-578-2439	ftp.zyxel.com ftp.europe.zyxel.com	
COSTA RICA	soporte@zyxel.co.cr	+506-2017878	www.zyxel.co.cr	ZyXEL Costa Rica Plaza Roble Escazú Etapa El Patio, Tercer Piso San José, Costa Rica
	sales@zyxel.co.cr	+506-2015098	ftp.zyxel.co.cr	
CZECH REPUBLIC	info@cz.zyxel.com	+420-241-091-350	www.zyxel.cz	ZyXEL Communications Czech s.r.o. Modranská 621 143 01 Praha 4 - Modrany Česká Republika
	info@cz.zyxel.com	+420-241-091-359		
DENMARK	support@zyxel.dk	+45-39-55-07-00	www.zyxel.dk	ZyXEL Communications A/S Columbusvej 2860 Soeborg Denmark
	sales@zyxel.dk	+45-39-55-07-07		
FINLAND	support@zyxel.fi	+358-9-4780-8411	www.zyxel.fi	ZyXEL Communications Oy Malminkaari 10 00700 Helsinki Finland
	sales@zyxel.fi	+358-9-4780 8448		
FRANCE	info@zyxel.fr	+33-4-72-52-97-97	www.zyxel.fr	ZyXEL France 1 rue des Vergers Bat. 1 / C 69760 Limonest France
		+33-4-72-52-19-20		
GERMANY	support@zyxel.de	+49-2405-6909-0	www.zyxel.de	ZyXEL Deutschland GmbH. Adenauerstr. 20/A2 D-52146 Wuerselen Germany
	sales@zyxel.de	+49-2405-6909-99		
HUNGARY	support@zyxel.hu	+36-1-3361649	www.zyxel.hu	ZyXEL Hungary 48, Zoldomb Str. H-1025, Budapest Hungary
	info@zyxel.hu	+36-1-3259100		
KAZAKHSTAN	http://zyxel.kz/support	+7-3272-590-698	www.zyxel.kz	ZyXEL Kazakhstan 43, Dostyk ave., Office 414 Dostyk Business Centre 050010, Almaty Republic of Kazakhstan
	sales@zyxel.kz	+7-3272-590-689		
NORTH AMERICA	support@zyxel.com	1-800-255-4101 +1-714-632-0882	www.us.zyxel.com	ZyXEL Communications Inc. 1130 N. Miller St. Anaheim CA 92806-2001 U.S.A.
	sales@zyxel.com	+1-714-632-0858	ftp.us.zyxel.com	

METHOD	SUPPORT E-MAIL	TELEPHONE	WEB SITE	REGULAR MAIL
	SALES E-MAIL	FAX	FTP SITE	
NORWAY	support@zyxel.no	+47-22-80-61-80	www.zyxel.no	ZyXEL Communications A/S Niils Hansens vei 13 0667 Oslo Norway
	sales@zyxel.no	+47-22-80-61-81		
POLAND	info@pl.zyxel.com	+48 (22) 333 8250	www.pl.zyxel.com	ZyXEL Communications ul. Okrzei 1A 03-715 Warszawa Poland
		+48 (22) 333 8251		
RUSSIA	http://zyxel.ru/support	+7-095-542-89-29	www.zyxel.ru	ZyXEL Russia Ostrovityanova 37a Str. Moscow, 117279 Russia
	sales@zyxel.ru	+7-095-542-89-25		
SPAIN	support@zyxel.es	+34-902-195-420	www.zyxel.es	ZyXEL Communications Arte, 21 5ª planta 28033 Madrid Spain
	sales@zyxel.es	+34-913-005-345		
SWEDEN	support@zyxel.se	+46-31-744-7700	www.zyxel.se	ZyXEL Communications A/S Sjöporten 4, 41764 Göteborg Sweden
	sales@zyxel.se	+46-31-744-7701		
UKRAINE	support@ua.zyxel.com	+380-44-247-69-78	www.ua.zyxel.com	ZyXEL Ukraine 13, Pimonenko Str. Kiev, 04050 Ukraine
	sales@ua.zyxel.com	+380-44-494-49-32		
UNITED KINGDOM	support@zyxel.co.uk	+44-1344 303044 08707 555779 (UK only)	www.zyxel.co.uk	ZyXEL Communications UK Ltd., 11 The Courtyard, Eastern Road, Bracknell, Berkshire, RG12 2XB, United Kingdom (UK)
	sales@zyxel.co.uk	+44-1344 303034	ftp.zyxel.co.uk	

+" is the (prefix) number you enter to make an international telephone call.

Table of Contents

Copyright	2
Certifications	3
Safety Warnings	5
ZyXEL Limited Warranty	6
Customer Support	7
Table of Contents	10
List of Figures	16
List of Tables	20
Preface	22
Chapter 1	
Getting To Know Your ZyXEL Device	24
1.1 Introducing the ZyXEL Device	24
1.2 Features	25
1.3 Applications for the ZyXEL Device	27
1.3.1 Internet Access	27
1.3.2 LAN to LAN Application	27
1.4 Front Panel Lights	27
1.5 Hardware Connection	28
Chapter 2	
Introducing the Web Configurator	30
2.1 Web Configurator Overview	30
2.2 Accessing the Web Configurator	30
2.3 Resetting the ZyXEL Device	32
2.3.1 Using the Reset Button	32
2.4 Navigating the Web Configurator	32
2.4.1 Navigation Panel	32
2.4.2 Status Screen	34
2.4.3 Status: Any IP Table	36
2.4.4 Status: Packet Statistics	37
2.4.5 Changing Login Password	38

Chapter 3	
Wizard Setup for Internet Access	40
3.1 Introduction	40
3.2 Internet Access Wizard Setup	40
3.2.1 Automatic Detection	42
3.2.2 Manual Configuration	42
Chapter 4	
WAN Setup.....	48
4.1 WAN Overview	48
4.1.1 Encapsulation	48
4.1.1.1 ENET ENCAP	48
4.1.1.2 PPP over Ethernet	48
4.1.1.3 PPPoA	49
4.1.1.4 RFC 1483	49
4.1.2 Multiplexing	49
4.1.2.1 VC-based Multiplexing	49
4.1.2.2 LLC-based Multiplexing	49
4.1.3 Encapsulation and Multiplexing Scenarios	49
4.1.3.1 Scenario 1: One VC, Multiple Protocols	50
4.1.3.2 Scenario 2: One VC, One Protocol (IP)	50
4.1.3.3 Scenario 3: Multiple VCs	50
4.1.4 VPI and VCI	50
4.1.5 IP Address Assignment	50
4.1.5.1 IP Assignment with PPPoA or PPPoE Encapsulation	50
4.1.5.2 IP Assignment with RFC 1483 Encapsulation	50
4.1.5.3 IP Assignment with ENET ENCAP Encapsulation	51
4.1.6 Nailed-Up Connection (PPP)	51
4.1.7 NAT	51
4.2 Metric	51
4.3 Traffic Shaping	52
4.3.1 ATM Traffic Classes	53
4.3.1.1 Constant Bit Rate (CBR)	53
4.3.1.2 Variable Bit Rate (VBR)	53
4.3.1.3 Unspecified Bit Rate (UBR)	53
4.4 Zero Configuration Internet Access	53
4.5 Internet Connection	54
4.5.1 Configuring Advanced Internet Connection Setup	56
4.6 Configuring More Connections	57
4.6.1 More Connections Edit	58
4.6.2 Configuring More Connections Advanced Setup	61
4.7 Traffic Redirect	62
4.8 Configuring WAN Backup	63

Chapter 5	
LAN Setup	66
5.1 LAN Overview	66
5.1.1 LANs, WANs and the ZyXEL Device	66
5.1.2 DHCP Setup	67
5.1.2.1 IP Pool Setup	67
5.1.3 DNS Server Address	67
5.1.4 DNS Server Address Assignment	68
5.2 LAN TCP/IP	68
5.2.1 IP Address and Subnet Mask	68
5.2.1.1 Private IP Addresses	69
5.2.2 RIP Setup	69
5.2.3 Multicast	70
5.2.4 Any IP	70
5.2.4.1 How Any IP Works	71
5.3 Configuring LAN IP	72
5.3.1 Configuring Advanced LAN Setup	72
5.4 DHCP Setup	74
5.5 LAN Client List	75
5.6 LAN IP Alias	76
Chapter 6	
Network Address Translation (NAT) Screens	80
6.1 NAT Overview	80
6.1.1 NAT Definitions	80
6.1.2 What NAT Does	81
6.1.3 How NAT Works	81
6.1.4 NAT Application	82
6.1.5 NAT Mapping Types	82
6.2 SUA (Single User Account) Versus NAT	83
6.3 NAT General Setup	83
6.4 Port Forwarding	84
6.4.1 Default Server IP Address	85
6.4.2 Port Forwarding: Services and Port Numbers	85
6.4.3 Configuring Servers Behind Port Forwarding (Example)	86
6.5 Configuring Port Forwarding	86
6.5.1 Port Forwarding Rule Edit	87
6.6 Address Mapping	88
6.6.1 Address Mapping Rule Edit	90
Chapter 7	
Static Route	92
7.1 Static Route	92

7.2 Configuring Static Route	92
7.2.1 Static Route Edit	93
Chapter 8	
Dynamic DNS Setup.....	96
8.1 Dynamic DNS Overview	96
8.1.1 DYNDNS Wildcard	96
8.2 Configuring Dynamic DNS	96
Chapter 9	
Remote Management Configuration	100
9.1 Remote Management Overview	100
9.1.1 Remote Management Limitations	100
9.1.2 Remote Management and NAT	101
9.1.3 System Timeout	101
9.2 WWW	101
9.3 Telnet	102
9.4 Configuring Telnet	102
9.5 Configuring FTP	103
9.6 SNMP	104
9.6.1 Supported MIBs	105
9.6.2 SNMP Traps	105
9.6.3 Configuring SNMP	106
9.7 Configuring DNS	107
9.8 Configuring ICMP	108
Chapter 10	
Universal Plug-and-Play (UPnP)	110
10.1 Introducing Universal Plug and Play	110
10.1.1 How do I know if I'm using UPnP?	110
10.1.2 NAT Traversal	110
10.1.3 Cautions with UPnP	111
10.2 UPnP and ZyXEL	111
10.2.1 Configuring UPnP	111
10.3 Installing UPnP in Windows Example	112
10.3.1 Installing UPnP in Windows Me	112
10.3.2 Installing UPnP in Windows XP	114
10.4 Using UPnP in Windows XP Example	115
10.4.1 Auto-discover Your UPnP-enabled Network Device	115
10.4.2 Web Configurator Easy Access	118

Chapter 11	
System	122
11.1 General Setup	122
11.1.1 General Setup and System Name	122
11.1.2 General Setup	122
11.2 Time Setting	124
Chapter 12	
Tools	128
12.1 Firmware Upgrade	128
12.2 Configuration Screen	130
12.2.1 Backup Configuration	130
12.2.2 Restore Configuration	131
12.2.3 Back to Factory Defaults	132
12.3 Restart	132
Chapter 13	
Diagnostic	134
13.1 General Diagnostic	134
13.2 DSL Line Diagnostic	135
Chapter 14	
Troubleshooting	136
14.1 Problems Starting Up the ZyXEL Device	136
14.2 Problems with the LAN	136
14.3 Problems with the WAN	137
14.4 Problems Accessing the ZyXEL Device	138
Appendix A	
Product Specifications	140
Appendix B	
Internal SPTGEN	142
Internal SPTGEN Overview	142
The Configuration Text File Format.....	142
Internal SPTGEN FTP Download Example.....	143
Internal SPTGEN FTP Upload Example	144
Example Internal SPTGEN Menus.....	145
Command Examples.....	159
Appendix C	
Wall-mounting Instructions.....	160

Appendix D	
Setting up Your Computer's IP Address.....	162
Windows 95/98/Me.....	162
Windows 2000/NT/XP	165
Macintosh OS 8/9.....	170
Macintosh OS X	172
Linux.....	173
Appendix E	
IP Addresses and Subnetting	178
Introduction to IP Addresses	178
Subnet Masks	180
Subnetting	180
Example: Two Subnets	181
Example: Four Subnets.....	182
Example Eight Subnets.....	183
Subnetting With Class A and Class B Networks.....	184
Appendix F	
Command Interpreter.....	186
Accessing the CLI	186
Command Syntax.....	186
Command Usage	186
Appendix G	
NetBIOS Filter Commands	188
Introduction	188
Display NetBIOS Filter Settings	188
NetBIOS Filter Configuration.....	189
Appendix H	
Splitters and Microfilters	190
Connecting a POTS Splitter	190
Telephone Microfilters	190
ZyXEL Device With ISDN.....	192
Appendix I	
Pop-up Windows, JavaScripts and Java Permissions	194
Internet Explorer Pop-up Blockers	194
JavaScripts.....	197
Index.....	202

List of Figures

Figure 1 Internet Access Applications	27
Figure 2 LAN-to-LAN Application Example	27
Figure 3 Front Panel (P-660R-D1)	28
Figure 4 Password Screen	31
Figure 5 Change Password at Login	31
Figure 6 Select a Mode	32
Figure 7 Web Configurator: Main Screen	33
Figure 8 Status Screen	35
Figure 9 Status: Any IP Table	36
Figure 10 Status: Packet Statistics	37
Figure 11 System General	39
Figure 12 Select a Mode	40
Figure 13 Wizard: Welcome	41
Figure 14 Auto Detection: No DSL Connection	41
Figure 15 Auto Detection: Failed	42
Figure 16 Auto-Detection: PPPoE	42
Figure 17 Internet Access Wizard Setup: ISP Parameters	43
Figure 18 Internet Connection with PPPoE	44
Figure 19 Internet Connection with RFC 1483	44
Figure 20 Internet Connection with ENET ENCAP	45
Figure 21 Internet Connection with PPPoA	46
Figure 22 Connection Test Failed-1	47
Figure 23 Connection Test Failed-2.	47
Figure 24 Internet Setup Wizard Finished	47
Figure 25 Example of Traffic Shaping	52
Figure 26 Internet Connection (PPPoE)	54
Figure 27 Advanced Internet Connection Setup	56
Figure 28 More Connections	58
Figure 29 More Connections Edit	59
Figure 30 More Connections Advanced Setup	61
Figure 31 Traffic Redirect Example	62
Figure 32 Traffic Redirect LAN Setup	63
Figure 33 WAN Backup Setup	63
Figure 34 LAN and WAN IP Addresses	66
Figure 35 Any IP Example	71
Figure 36 LAN IP	72
Figure 37 Advanced LAN Setup	73
Figure 38 DHCP Setup	74

Figure 39 LAN Client List	75
Figure 40 Physical Network & Partitioned Logical Networks	77
Figure 41 LAN IP Alias	77
Figure 42 How NAT Works	81
Figure 43 NAT Application With IP Alias	82
Figure 44 NAT General	84
Figure 45 Multiple Servers Behind NAT Example	86
Figure 46 NAT Port Forwarding	86
Figure 47 Port Forwarding Rule Setup	87
Figure 48 Address Mapping Rules	89
Figure 49 Edit Address Mapping Rule	90
Figure 50 Example of Static Routing Topology	92
Figure 51 Static Route	93
Figure 52 Static Route Edit	94
Figure 53 Dynamic DNS	97
Figure 54 Remote Management: WWW	101
Figure 55 Telnet Configuration on a TCP/IP Network	102
Figure 56 Remote Management: Telnet	102
Figure 57 Remote Management: FTP	103
Figure 58 SNMP Management Model	104
Figure 59 Remote Management: SNMP	106
Figure 60 Remote Management: DNS	107
Figure 61 Remote Management: ICMP	108
Figure 62 Configuring UPnP	111
Figure 63 Add/Remove Programs: Windows Setup: Communication	113
Figure 64 Add/Remove Programs: Windows Setup: Communication: Components	113
Figure 65 Network Connections	114
Figure 66 Windows Optional Networking Components Wizard	114
Figure 67 Networking Services	115
Figure 68 Network Connections	116
Figure 69 Internet Connection Properties	116
Figure 70 Internet Connection Properties: Advanced Settings	117
Figure 71 Internet Connection Properties: Advanced Settings: Add	117
Figure 72 System Tray Icon	117
Figure 73 Internet Connection Status	118
Figure 74 Network Connections	119
Figure 75 Network Connections: My Network Places	120
Figure 76 Network Connections: My Network Places: Properties: Example	120
Figure 77 System General Setup	123
Figure 78 System Time Setting	124
Figure 79 Firmware Upgrade	128
Figure 80 Firmware Upload In Progress	129
Figure 81 Network Temporarily Disconnected	129

Figure 82 Error Message	130
Figure 83 Configuration	130
Figure 84 Configuration Restore Successful	131
Figure 85 Temporarily Disconnected	131
Figure 86 Configuration Restore Error	132
Figure 87 Restart Screen	132
Figure 88 Diagnostic: General	134
Figure 89 Diagnostic: DSL Line	135
Figure 90 Configuration Text File Format: Column Descriptions	142
Figure 91 Invalid Parameter Entered: Command Line Example	143
Figure 92 Valid Parameter Entered: Command Line Example	143
Figure 93 Internal SPTGEN FTP Download Example	144
Figure 94 Internal SPTGEN FTP Upload Example	144
Figure 95 Wall-mounting Example	160
Figure 96 WIndows 95/98/Me: Network: Configuration	163
Figure 97 Windows 95/98/Me: TCP/IP Properties: IP Address	164
Figure 98 Windows 95/98/Me: TCP/IP Properties: DNS Configuration	165
Figure 99 Windows XP: Start Menu	166
Figure 100 Windows XP: Control Panel	166
Figure 101 Windows XP: Control Panel: Network Connections: Properties	167
Figure 102 Windows XP: Local Area Connection Properties	167
Figure 103 Windows XP: Internet Protocol (TCP/IP) Properties	168
Figure 104 Windows XP: Advanced TCP/IP Properties	169
Figure 105 Windows XP: Internet Protocol (TCP/IP) Properties	170
Figure 106 Macintosh OS 8/9: Apple Menu	171
Figure 107 Macintosh OS 8/9: TCP/IP	171
Figure 108 Macintosh OS X: Apple Menu	172
Figure 109 Macintosh OS X: Network	173
Figure 110 Red Hat 9.0: KDE: Network Configuration: Devices	174
Figure 111 Red Hat 9.0: KDE: Ethernet Device: General	174
Figure 112 Red Hat 9.0: KDE: Network Configuration: DNS	175
Figure 113 Red Hat 9.0: KDE: Network Configuration: Activate	175
Figure 114 Red Hat 9.0: Dynamic IP Address Setting in ifconfig-eth0	176
Figure 115 Red Hat 9.0: Static IP Address Setting in ifconfig-eth0	176
Figure 116 Red Hat 9.0: DNS Settings in resolv.conf	176
Figure 117 Red Hat 9.0: Restart Ethernet Card	177
Figure 118 Red Hat 9.0: Checking TCP/IP Properties	177
Figure 119 Connecting a POTS Splitter	190
Figure 120 Connecting a Microfilter	191
Figure 121 Connecting a Microfilter and Y-Connector	191
Figure 122 ZyXEL Device with ISDN	192
Figure 123 Pop-up Blocker	194
Figure 124 Internet Options	195

Figure 125 Internet Options	196
Figure 126 Pop-up Blocker Settings	197
Figure 127 Internet Options	198
Figure 128 Security Settings - Java Scripting	199
Figure 129 Security Settings - Java	200
Figure 130 Java (Sun)	201

List of Tables

Table 1 ADSL Standards	25
Table 2 Front Panel Lights	28
Table 3 Web Configurator Screens Summary	33
Table 4 Status Screen	35
Table 5 Status: Any IP Table	37
Table 6 Status: Packet Statistics	38
Table 7 Internet Access Wizard Setup: ISP Parameters	43
Table 8 Internet Connection with PPPoE	44
Table 9 Internet Connection with RFC 1483	45
Table 10 Internet Connection with ENET ENCAP	45
Table 11 Internet Connection with PPPoA	46
Table 12 Internet Connection	54
Table 13 Advanced Internet Connection Setup	56
Table 14 More Connections	58
Table 15 More Connections Edit	59
Table 16 More Connections Advanced Setup	61
Table 17 WAN Backup Setup	64
Table 18 LAN IP	72
Table 19 Advanced LAN Setup	73
Table 20 DHCP Setup	74
Table 21 LAN Client List	76
Table 22 LAN IP Alias	77
Table 23 NAT Definitions	80
Table 24 NAT Mapping Types	83
Table 25 NAT General	84
Table 26 Services and Port Numbers	85
Table 27 NAT Port Forwarding	87
Table 28 Port Forwarding Rule Setup	88
Table 29 Address Mapping Rules	89
Table 30 Edit Address Mapping Rule	90
Table 31 Static Route	93
Table 32 Static Route Edit	94
Table 33 Dynamic DNS	97
Table 34 Remote Management: WWW	101
Table 35 Remote Management: Telnet	103
Table 36 Remote Management: FTP	104
Table 37 SNMP Traps	105
Table 38 Remote Management: SNMP	106

Table 39 Remote Management: DNS	107
Table 40 Remote Management: ICMP	108
Table 41 Configuring UPnP	112
Table 42 System General Setup	123
Table 43 System Time Setting	125
Table 44 Firmware Upgrade	128
Table 45 Maintenance Restore Configuration	131
Table 46 Diagnostic: General	134
Table 47 Diagnostic: DSL Line	135
Table 48 Troubleshooting Starting Up Your ZyXEL Device	136
Table 49 Troubleshooting the LAN	136
Table 50 Troubleshooting the WAN	137
Table 51 Troubleshooting Accessing the ZyXEL Device	138
Table 52 Device	140
Table 53 Firmware	141
Table 54 Abbreviations Used in the Example Internal SPTGEN Screens Table	145
Table 55 Menu 1 General Setup	145
Table 56 Menu 3	145
Table 57 Menu 4 Internet Access Setup	151
Table 58 Menu 12	152
Table 59 Menu 15 SUA Server Setup	153
Table 60 Menu 21.1 Filter Set #1	154
Table 61 Menu 21.1 Filter Set #2,	156
Table 62 Menu 23 System Menus	157
Table 63 Menu 24.11 Remote Management Control	158
Table 64 Command Examples	159
Table 65 Classes of IP Addresses	179
Table 66 Allowed IP Address Range By Class	179
Table 67 "Natural" Masks	180
Table 68 Alternative Subnet Mask Notation	180
Table 69 Two Subnets Example	181
Table 70 Subnet 1	181
Table 71 Subnet 2	182
Table 72 Subnet 1	182
Table 73 Subnet 2	183
Table 74 Subnet 3	183
Table 75 Subnet 4	183
Table 76 Eight Subnets	184
Table 77 Class C Subnet Planning	184
Table 78 Class B Subnet Planning	185
Table 79 NetBIOS Filter Default Settings	189

Preface

Congratulations on your purchase of the P-660R-D series ADSL 2+ Gateway. The P-660R-D is ideal for connecting your home or business to the Internet.

Note: Register your product online to receive e-mail notices of firmware upgrades and information at www.zyxel.com for global products, or at www.us.zyxel.com for North American products.

About This User's Guide

This manual is designed to guide you through the configuration of your ZyXEL Device for its various applications. The web configurator parts of this guide contain background information on features configurable by web configurator.

Note: Use the web configurator or command interpreter interface to configure your ZyXEL Device. Not all features can be configured through all interfaces.

Syntax Conventions

- “Enter” means for you to type one or more characters. “Select” or “Choose” means for you to use one predefined choice.
- Mouse action sequences are denoted using a right angle bracket (>). For example, “In Windows, click **Start > Settings > Control Panel**” means first click the **Start** button, then point your mouse pointer to **Settings** and then click **Control Panel**.
- “e.g.,” is a shorthand for “for instance”, and “i.e.,” means “that is” or “in other words”.
- The ZyXEL Device series may be referred to as the “ZyXEL Device” in this User’s Guide.









Related Documentation

- Supporting Disk
Refer to the included CD for support documents.
- Quick Start Guide
The Quick Start Guide is designed to help you get up and running right away. It contains connection information and instructions on getting started.
- Web Configurator Online Help
Embedded web help for descriptions of individual screens and supplementary information.
- ZyXEL Web Site
Please go to <http://www.zyxel.com> for product news, firmware, updated documents, and other support materials.

User Guide Feedback

Help us help you. E-mail all User Guide-related comments, questions or suggestions for improvement to techwriters@zyxel.com.tw or send regular mail to The Technical Writing Team, ZyXEL Communications Corp., 6 Innovation Road II, Science-Based Industrial Park, Hsinchu, 300, Taiwan. Thank you.

Graphics Icons Key

ZyXEL Device 	Computer 	Notebook computer 
Server 	DSLAM 	Firewall 
Telephone 	Switch 	Router 

CHAPTER 1

Getting To Know Your ZYXEL DEVICE

This chapter describes the key features and applications of your ZyXEL Device.

1.1 Introducing the ZyXEL Device

The ZyXEL Device is an ADSL2+ gateway that allows super-fast Internet access over analog (POTS) or digital (ISDN) telephone lines (depending on your model).

In the ZyXEL Device product name, “R” denotes an integrated router and “D” denotes a chip set standard.

Your ZyXEL Device product name ends with a number. Models ending in “1”, for example P-660R-D1, denote a device that works over the analog telephone system, POTS (Plain Old Telephone Service). Models ending in “3” denote a device that works over ISDN (Integrated Services Digital Network). Models ending in “7” denote a device that works over T-ISDN (UR-2).

Note: Only use firmware for your ZyXEL Device’s specific model. Refer to the label on the bottom of your ZyXEL Device.

1.2 Features

High Speed Internet Access

The DSL RJ-11 (ADSL over POTS models) or RJ-45 (ADSL over ISDN models) connects to your ADSL-enabled telephone line. The ZyXEL Device is compatible with the ADSL/ADSL2/ADSL2+ standards. Maximum data rates attainable for each standard are shown in the next table.

Table 1 ADSL Standards

DATA RATE STANDARD	UPSTREAM	DOWNSTREAM
ADSL	832 kbps	8Mbps
ADSL2	3.5Mbps	12Mbps
ADSL2+	3.5Mbps	24Mbps

Note: If your ZyXEL Device does not support Annex M, the maximum ADSL2/2+ upstream data rate is 1.2 Mbps. ZyXEL Devices which work over ISDN do not support Annex M.

The standard your ISP supports determines the maximum upstream and downstream speeds attainable. Actual speeds attained also depend on the distance from your ISP, line quality, etc.

Zero Configuration Internet Access

Once you connect and turn on the ZyXEL Device, it automatically detects the Internet connection settings (such as the VCI/VPI numbers and the encapsulation method) from the ISP and makes the necessary configuration changes. In cases where additional account information (such as an Internet account user name and password) is required or the ZyXEL Device cannot connect to the ISP, you will be redirected to web screen(s) for information input or troubleshooting.

Any IP

The Any IP feature allows a computer to access the Internet and the ZyXEL Device without changing the network settings (such as IP address and subnet mask) of the computer, when the IP addresses of the computer and the ZyXEL Device are not in the same subnet.

Traffic Redirect

Traffic redirect forwards WAN traffic to a backup gateway when the ZyXEL Device cannot connect to the Internet, thus acting as an auxiliary if your regular WAN connection fails.

Universal Plug and Play (UPnP)

Using the standard TCP/IP protocol, the ZyXEL Device and other UPnP enabled devices can dynamically join a network, obtain an IP address and convey its capabilities to other devices on the network.

PPPoE (RFC2516)

PPPoE (Point-to-Point Protocol over Ethernet) emulates a dial-up connection. It allows your ISP to use their existing network configuration with newer broadband technologies such as ADSL. The PPPoE driver on the ZyXEL Device is transparent to the computers on the LAN, which see only Ethernet and are not aware of PPPoE thus saving you from having to manage PPPoE clients on individual computers. The ZyXEL Device also includes PPPoE idle time-out (the PPPoE connection terminates after a period of no traffic that you configure) and PPPoE Dial-on-Demand (the PPPoE connection is brought up only when an Internet access request is made).

Network Address Translation (NAT)

Network Address Translation (NAT) allows the translation of an Internet protocol address used within one network (for example a private IP address used in a local network) to a different IP address known within another network (for example a public IP address used on the Internet).

Dynamic DNS Support

With Dynamic DNS support, you can have a static hostname alias for a dynamic IP address, allowing the host to be more easily accessible from various locations on the Internet. You must register for this service with a Dynamic DNS service provider.

DHCP

DHCP (Dynamic Host Configuration Protocol) allows the individual clients (computers) to obtain the TCP/IP configuration at start-up from a centralized DHCP server. The ZyXEL Device has built-in DHCP server capability enabled by default. It can assign IP addresses, an IP default gateway and DNS servers to DHCP clients. The ZyXEL Device can now also act as a surrogate DHCP server (DHCP Relay) where it relays IP address assignment from the actual real DHCP server to the clients.

IP Alias

IP Alias allows you to partition a physical network into logical networks over the same Ethernet interface. The ZyXEL Device supports three logical LAN interfaces via its single physical Ethernet interface with the ZyXEL Device itself as the gateway for each LAN network.

Housing

Your ZyXEL Device's compact and ventilated housing minimizes space requirements making it easy to position anywhere in your busy office.

1.3 Applications for the ZyXEL Device

Here are some example uses for which the ZyXEL Device is well suited.

1.3.1 Internet Access

The ZyXEL Device is the ideal high-speed Internet access solution. It is compatible with all major ADSL DSLAM (Digital Subscriber Line Access Multiplexer) providers and supports the ADSL standards as shown in [Table 1 on page 25](#).

Figure 1 Internet Access Applications

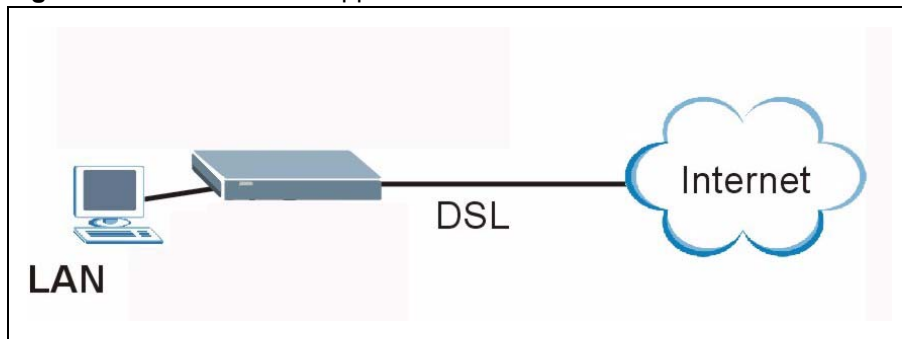

1.3.2 LAN to LAN Application

You can use the ZyXEL Device to connect two geographically dispersed networks over the ADSL line. A typical LAN-to-LAN application example is shown as follows.

Figure 2 LAN-to-LAN Application Example

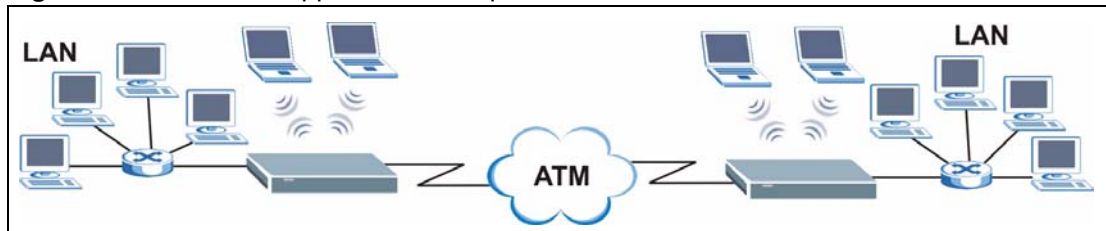

1.4 Front Panel Lights

The following figure shows the front panel lights.

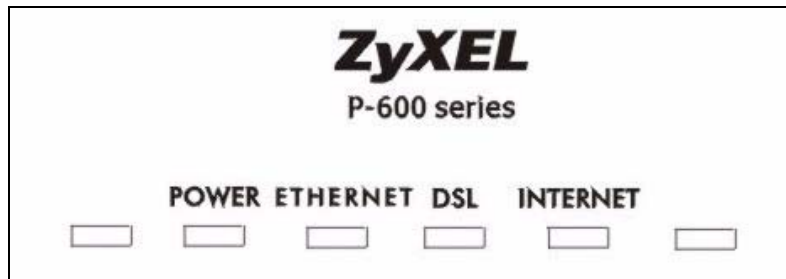
Figure 3 Front Panel (P-660R-D1)

The following table describes the lights.

Table 2 Front Panel Lights

LIGHT	COLOR	STATUS	DESCRIPTION
POWER	Green	On	The ZyXEL Device is receiving power and functioning properly.
		Blinking	The ZyXEL Device is rebooting or performing diagnostics.
	Red	On	Power to the ZyXEL Device is too low.
		Off	The ZyXEL Device is turned off. The system is not receiving power.
ETHERNET	Green	On	The ZyXEL Device has a successful 10Mbps Ethernet connection.
		Blinking	The ZyXEL Device is receiving or sending data.
	Amber	On	The ZyXEL Device has a successful 100Mbps Ethernet connection.
		Blinking	The ZyXEL Device is receiving or sending data.
		Off	The ZyXEL Device is not connected to the LAN.
DSL	Green	On	The DSL line is up.
		Blinking	The ZyXEL Device is initializing the DSL line.
		Off	The DSL line is down.
INTERNET	Green	On	The Internet connection is up.
		Blinking	The ZyXEL Device is sending/receiving data.
		Off	The Internet connection is down.

1.5 Hardware Connection

Refer to the Quick Start Guide for information on hardware connection.

CHAPTER 2

Introducing the Web Configurator

This chapter describes how to access and navigate the web configurator.

2.1 Web Configurator Overview

The web configurator is an HTML-based management interface that allows easy ZyXEL Device setup and management via Internet browser. Use Internet Explorer 6.0 and later or Netscape Navigator 7.0 and later versions. The recommended screen resolution is 1024 by 768 pixels.

In order to use the web configurator you need to allow:

- Web browser pop-up windows from your device. Web pop-up blocking is enabled by default in Windows XP SP (Service Pack) 2.
- JavaScripts (enabled by default).
- Java permissions (enabled by default).

See the chapter on troubleshooting if you need to make sure these functions are allowed in Internet Explorer.

2.2 Accessing the Web Configurator

- 1** Make sure your ZyXEL Device hardware is properly connected (refer to the Quick Start Guide).
- 2** Prepare your computer/computer network to connect to the ZyXEL Device (refer to the Quick Start Guide).
- 3** Launch your web browser.
- 4** Type "192.168.1.1" as the URL.
- 5** A window displays as shown. Enter the default admin password **1234** to configure the wizards and the advanced features or enter the default user password **user** to view the status only. Click **Login** to proceed to a screen asking you to change your password or click **Cancel** to revert to the default password.

Figure 4 Password ScreenThe image shows the ZyXEL P-660R-D1 password screen. At the top, the ZyXEL logo is displayed in white on a blue background. Below the logo, the text "P-660R-D1" is centered. Underneath, it says "Welcome to your router Configuration Interface" and "Enter your password and press enter or click 'Login'". There is a password input field with a key icon and the text "Password:" followed by a white text box containing four asterisks. Below the input field are two buttons: "Login" and "Cancel".

- 6 If you entered the user password, skip the next two steps and refer to [Section 2.4.2 on page 34](#) for more information about the **Status** screen.

If you entered the admin password, it is highly recommended you change the default admin password! Enter a new password between 1 and 30 characters, retype it to confirm and click **Apply**; alternatively click **Ignore** to proceed to the main menu if you do not want to change the password now.

Note: If you do not change the password at least once, the following screen appears every time you log in with the admin password.

Figure 5 Change Password at LoginThe image shows the ZyXEL "Change Password at Login" screen. At the top, the ZyXEL logo is displayed in white on a blue background. Below the logo, the text "Use this screen to change the password." is centered. Underneath, there is a paragraph of text: "Your router is currently using the default password. To protect your network from unauthorized users we suggest you change your password at this time. Please select a new password that will be easy to remember yet difficult for others to guess. We suggest you combine text with numbers to make it more difficult for an intruder to guess." Below this text, there is another paragraph: "Enter your new password in the two fields below and click 'Apply'. Otherwise click 'Ignore' to keep the default password". There are two password input fields: "New Password:" and "Retype to Confirm:". Below the input fields are two buttons: "Apply" and "Ignore".

- 7 Select **Go to Wizard setup** and click **Apply** to display the wizard main screen. Otherwise, select **Go to Advanced setup** and click **Apply** to display the **Status** screen.

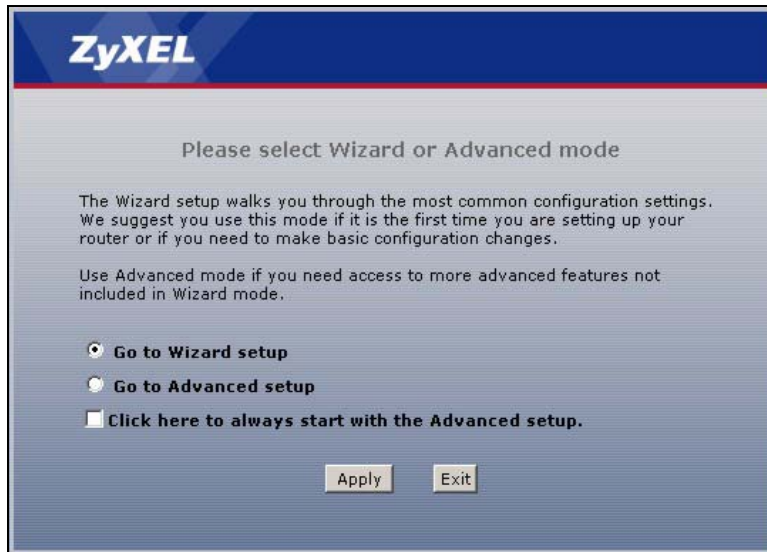
Figure 6 Select a Mode

Note: The management session automatically times out when the time period set in the **Administrator Inactivity Timer** field expires (default five minutes). Simply log back into the ZyXEL Device if this happens to you.

2.3 Resetting the ZyXEL Device

If you forget your password or cannot access the web configurator, you will need to use the **RESET** button at the back of the ZyXEL Device to reload the factory-default configuration file. This means that you will lose all configurations that you had previously and the password will be reset to “1234”.

2.3.1 Using the Reset Button

- 1 Make sure the **POWER** light is on (not blinking).
- 2 Press the **RESET** button for ten seconds or until the **POWER** light begins to blink and then release it. When the **POWER** light begins to blink, the defaults have been restored and the ZyXEL Device restarts.

2.4 Navigating the Web Configurator

We use the P-660R-D1 web screens in this guide as an example. Screens vary slightly for different ZyXEL Device models.

2.4.1 Navigation Panel

After you enter the admin password, use the sub-menus on the navigation panel to configure ZyXEL Device features. The following table describes the sub-menus.

Figure 7 Web Configurator: Main Screen

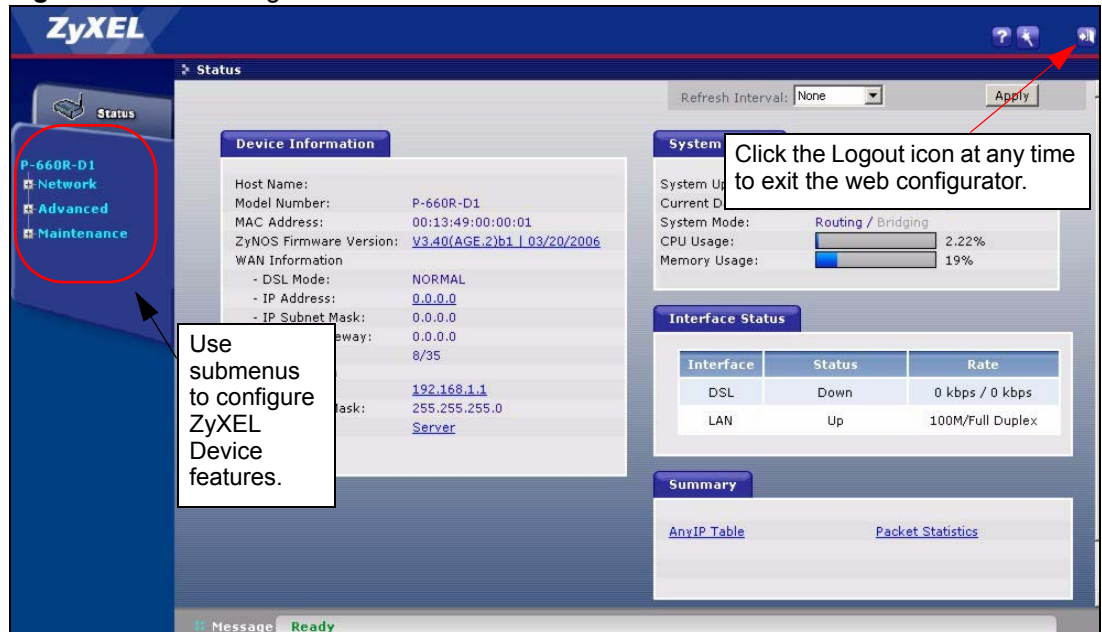

Note: Click the  icon (located in the top right corner of most screens) to view embedded help.

Table 3 Web Configurator Screens Summary



LINK/ICON	SUB-LINK	FUNCTION
Wizard 	INTERNET SETUP	Use these screens for initial configuration including general setup, ISP parameters for Internet Access and WAN IP/DNS Server/MAC address assignment.
Logout 		Click this icon to exit the web configurator.
Status		This screen shows the ZyXEL Device's general device, system and interface status information. Use this screen to access the summary statistics tables.
Network		
WAN	Internet Connection	This screen allows you to configure ISP parameters, WAN IP address assignment, DNS servers and other advanced properties.
	More Connections	Use this screen to view and configure other connections for placing calls to another remote gateway.
	WAN Backup Setup	Use this screen to configure your traffic redirect properties and WAN backup settings.
LAN	IP	Use this screen to configure LAN TCP/IP settings, enable Any IP and other advanced properties.
	DHCP Setup	Use this screen to configure LAN DHCP settings.
	Client List	Use this screen to view current DHCP client information and to always assign an IP address to a MAC address (and host name).
	IP Alias	Use this screen to partition your LAN interface into subnets.

Table 3 Web Configurator Screens Summary (continued)

LINK/ICON	SUB-LINK	FUNCTION
NAT	General	Use this screen to enable NAT.
	Port Forwarding	Use this screen to configure servers behind the ZyXEL Device.
Advanced		
Static Route		Use this screen to configure IP static routes.
Dynamic DNS		Use this screen to set up dynamic DNS.
Remote MGMT	WWW	Use this screen to configure through which interface(s) and from which IP address(es) users can use HTTPS or HTTP to manage the ZyXEL Device.
	Telnet	Use this screen to configure through which interface(s) and from which IP address(es) users can use Telnet to manage the ZyXEL Device.
	FTP	Use this screen to configure through which interface(s) and from which IP address(es) users can use FTP to access the ZyXEL Device.
	SNMP	Use this screen to configure your ZyXEL Device's settings for Simple Network Management Protocol management.
	DNS	Use this screen to configure through which interface(s) and from which IP address(es) users can send DNS queries to the ZyXEL Device.
	ICMP	Use this screen to change your anti-probing settings.
UPnP		Use this screen to enable UPnP on the ZyXEL Device.
Maintenance		
System	General	This screen contains administrative and system-related information and also allows you to change your password.
	Time Setting	Use this screen to change your ZyXEL Device's time and date.
Tools	Firmware	Use this screen to upload firmware to your ZyXEL Device.
	Configuration	Use this screen to backup and restore the configuration or reset the factory defaults to your ZyXEL Device.
	Restart	This screen allows you to reboot the ZyXEL Device without turning the power off.
Diagnostic	General	These screens display information to help you identify problems with the ZyXEL Device general connection.
	DSL Line	These screens display information to help you identify problems with the DSL line.

2.4.2 Status Screen

The following summarizes how to navigate the web configurator from the **Status** screen. Some fields or links are not available if you entered the user password in the login password screen (see [Figure 4 on page 31](#)). Not all fields are available on all models.

Figure 8 Status Screen

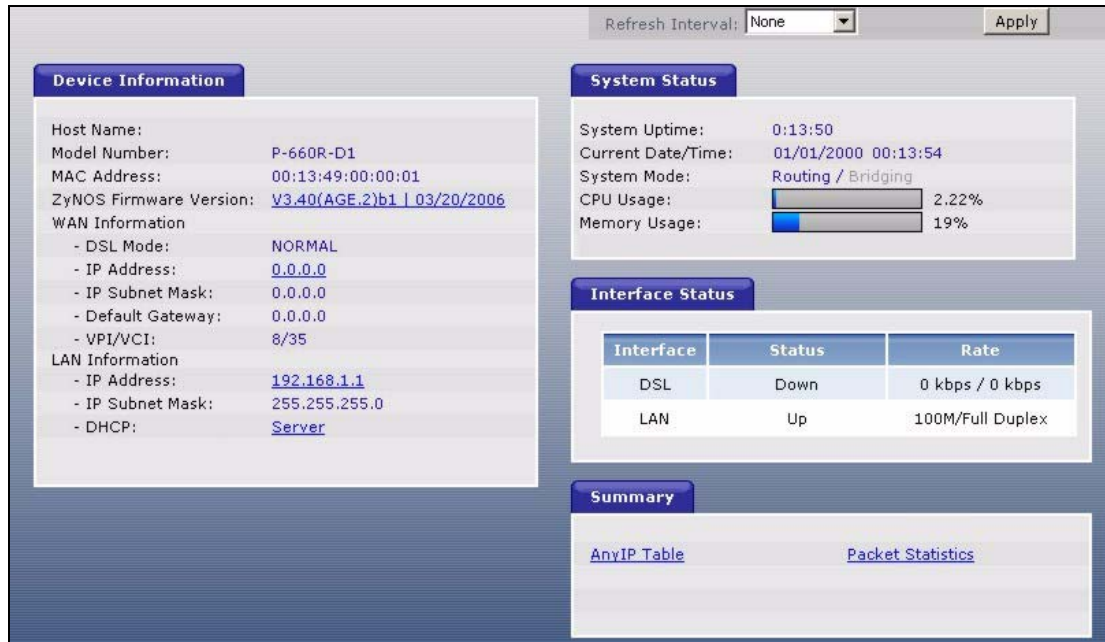

The following table describes the labels shown in the **Status** screen.

Table 4 Status Screen

LABEL	DESCRIPTION
Refresh Interval	Select a number of seconds or None from the drop-down list box to refresh all screen statistics automatically at the end of every time interval or to not refresh the screen statistics.
Apply	Click this button to refresh the status screen statistics.
Device Information	
Host Name	This is the System Name you enter in the Maintenance > System > General screen. It is for identification purposes.
Model Number	This is your ZyXEL Device's model name.
MAC Address	This is the MAC (Media Access Control) or Ethernet address unique to your ZyXEL Device.
ZyNOS Firmware Version	This is the ZyNOS Firmware version and the date created. ZyNOS is ZyXEL's proprietary Network Operating System design.
WAN Information	
DSL Mode	This is the standard that your ZyXEL Device is using.
IP Address	This is the DSL port IP address.
IP Subnet Mask	This is the DSL port IP subnet mask.
Default Gateway	This is the IP address of the default gateway, if applicable.
VPI/VCI	This is the Virtual Path Identifier and Virtual Channel Identifier that you entered in the wizard or WAN screen.
LAN Information	
IP Address	This is the ETHERNET port IP address.
IP Subnet Mask	This is the ETHERNET port IP subnet mask.

Table 4 Status Screen

LABEL	DESCRIPTION
DHCP	This is the ETHERNET port DHCP role - Server, Relay or None .
System Status	
System Uptime	This is the total time the ZyXEL Device has been on.
Current Date/Time	This field displays your ZyXEL Device's present date and time.
System Mode	This displays whether the ZyXEL Device is functioning as a router or a bridge.
CPU Usage	This number shows how many kilobytes of the heap memory the ZyXEL Device is using. Heap memory refers to the memory that is not used by ZyNOS (ZyXEL Network Operating System) and is thus available for running processes like NAT, VPN and the firewall. The bar displays what percent of the ZyXEL Device's heap memory is in use. The bar turns from green to red when the maximum is being approached.
Memory Usage	This number shows the ZyXEL Device's total heap memory (in kilobytes). The bar displays what percent of the ZyXEL Device's heap memory is in use. The bar turns from green to red when the maximum is being approached.
Interface Status	
Interface	This displays the ZyXEL Device port types.
Status	This field displays Down (line is down), Up (line is up or connected) if you're using Ethernet encapsulation and Down (line is down), Up (line is up or connected), Idle (line (ppp) idle), Dial (starting to trigger a call) and Drop (dropping a call) if you're using PPPoE encapsulation.
Rate	For the LAN ports, this displays the port speed and duplex setting. For the DSL port, it displays the downstream and upstream transmission rate.
Summary	
Any IP Table	Use this screen to view a list of IP addresses and MAC addresses of computers, which are not in the same subnet as the ZyXEL Device.
Packet Statistics	Use this screen to view port status and packet specific statistics.

2.4.3 Status: Any IP Table

Click the **Any IP Table** hyperlink in the **Status** screen. The Any IP table shows current read-only information (including the IP address and the MAC address) of all network devices that use the Any IP feature to communicate with the ZyXEL Device.

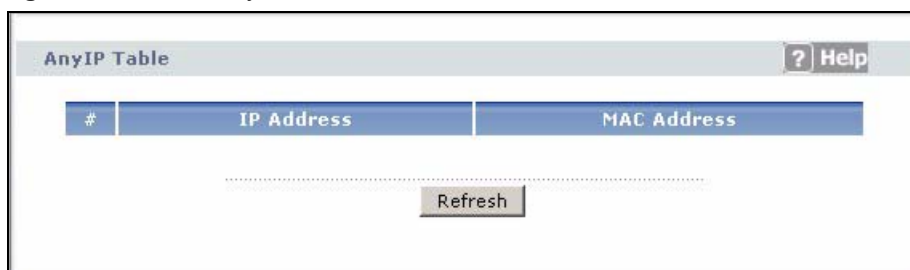
Figure 9 Status: Any IP Table

The following table describes the labels in this screen.

Table 5 Status: Any IP Table

LABEL	DESCRIPTION
#	This is the index number of the host computer.
IP Address	This field displays the IP address of the network device.
MAC Address	This field displays the MAC (Media Access Control) address of the computer with the displayed IP address. Every Ethernet device has a unique MAC address. The MAC address is assigned at the factory and consists of six pairs of hexadecimal characters, for example, 00:A0:C5:00:00:02.
Refresh	Click Refresh to update this screen.

2.4.4 Status: Packet Statistics

Click the **Packet Statistics** hyperlink in the **Status** screen. Read-only information here includes port status and packet specific statistics. Also provided are "system up time" and "poll interval(s)". The **Poll Interval(s)** field is configurable. Not all fields are available on all models

Figure 10 Status: Packet Statistics

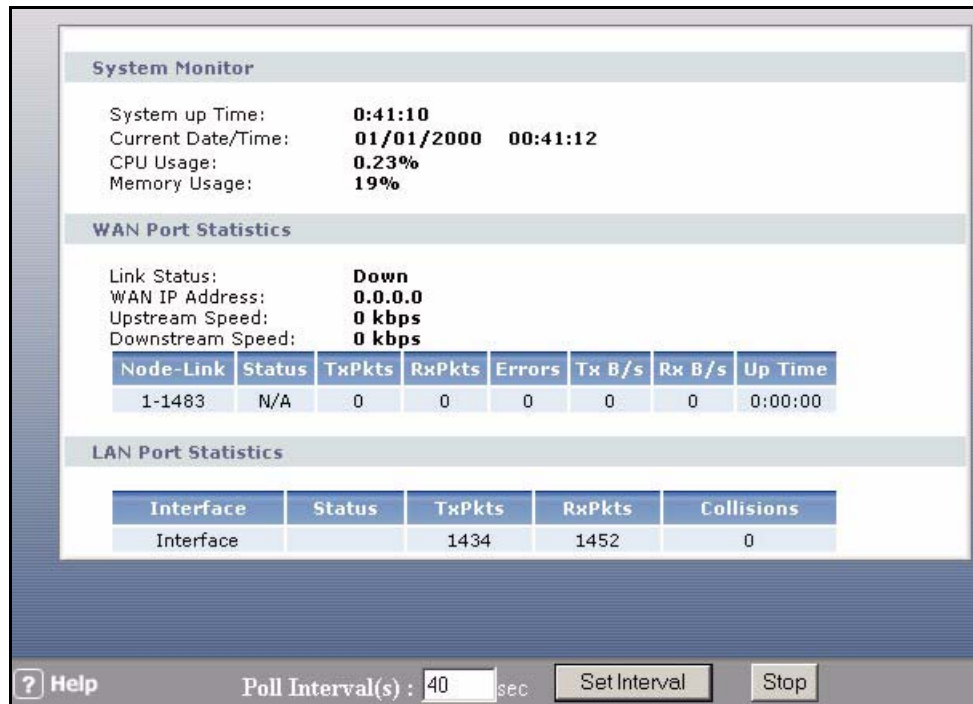

The following table describes the fields in this screen.

Table 6 Status: Packet Statistics

LABEL	DESCRIPTION
System Monitor	
System up Time	This is the elapsed time the system has been up.
Current Date/Time	This field displays your ZyXEL Device's present date and time.
CPU Usage	This field specifies the percentage of CPU utilization.
Memory Usage	This field specifies the percentage of memory utilization.
LAN or WAN Port Statistics	This is the WAN or LAN port.
Link Status	This is the status of your WAN link.
Upstream Speed	This is the upstream speed of your ZyXEL Device.
Downstream Speed	This is the downstream speed of your ZyXEL Device.
Node-Link	This field displays the remote node index number and link type. Link types are PPPoA, ENET, RFC 1483 and PPPoE.
Interface	This field displays the type of port.
Status	This field displays Down (line is down), Up (line is up or connected) if you're using Ethernet encapsulation and Down (line is down), Up (line is up or connected), Idle (line (ppp) idle), Dial (starting to trigger a call) and Drop (dropping a call) if you're using PPPoE encapsulation. For the WLAN port, it displays the transmission rate when WLAN is enabled or N/A when WLAN is disabled.
TxPkts	This field displays the number of packets transmitted on this port.
RxPkts	This field displays the number of packets received on this port.
Errors	This field displays the number of error packets on this port.
Tx B/s	This field displays the number of bytes transmitted in the last second.
Rx B/s	This field displays the number of bytes received in the last second.
Up Time	This field displays the elapsed time this port has been up.
Collisions	This is the number of collisions on this port.
Help	Click this button to bring the help screen.
Poll Interval(s)	Type the time interval for the browser to refresh system statistics.
Set Interval	Click this button to apply the new poll interval you entered in the Poll Interval field above.
Stop	Click this button to halt the refreshing of the system statistics.

2.4.5 Changing Login Password

It is highly recommended that you periodically change the password for accessing the ZyXEL Device. If you didn't change the default one after you logged in or you want to change to a new password again, then click **Maintenance > System** to display the screen as shown next. See [Table 42 on page 123](#) for detailed field descriptions.

Figure 11 System General

The screenshot displays a web configuration interface with two tabs: "General" (selected) and "Time Setting". The "System Setup" section includes fields for "System Name", "Domain Name", and "Administrator Inactivity Timer" (set to 60 minutes). The "Password" section, highlighted with a red rounded rectangle, contains fields for "User Password" (New Password, Retype to confirm) and "Admin Password" (Old Password, New Password, Retype to confirm). A caution message is present below the password fields, and "Apply" and "Cancel" buttons are at the bottom.

System Setup	
System Name	<input type="text"/>
Domain Name	<input type="text"/>
Administrator Inactivity Timer	<input type="text" value="60"/> (minutes, 0 means no timeout)

Password	
User Password	
New Password	<input type="text"/>
Retype to confirm	<input type="text"/>
Admin Password	
Old Password	<input type="text"/>
New Password	<input type="text"/>
Retype to confirm	<input type="text"/>

⚠ Caution:
Please record your new password whenever you change it. The system will lock you out if you have forgotten your password.

.....

CHAPTER 3

Wizard Setup for Internet Access

This chapter provides information on the Wizard Setup screens for Internet access in the web configurator.

3.1 Introduction

Use the wizard setup screens to configure your system for Internet access with the information given to you by your ISP.

Note: See the advanced menu chapters for background information on these fields.

3.2 Internet Access Wizard Setup

- 1 After you enter the admin password to access the web configurator, select **Go to Wizard setup** and click **Apply**. Otherwise, click the wizard icon () in the top right corner of the web configurator to display the wizard main screen.

Figure 12 Select a Mode



- 2 Click **INTERNET SETUP** to configure the system for Internet access.

Figure 13 Wizard: Welcome

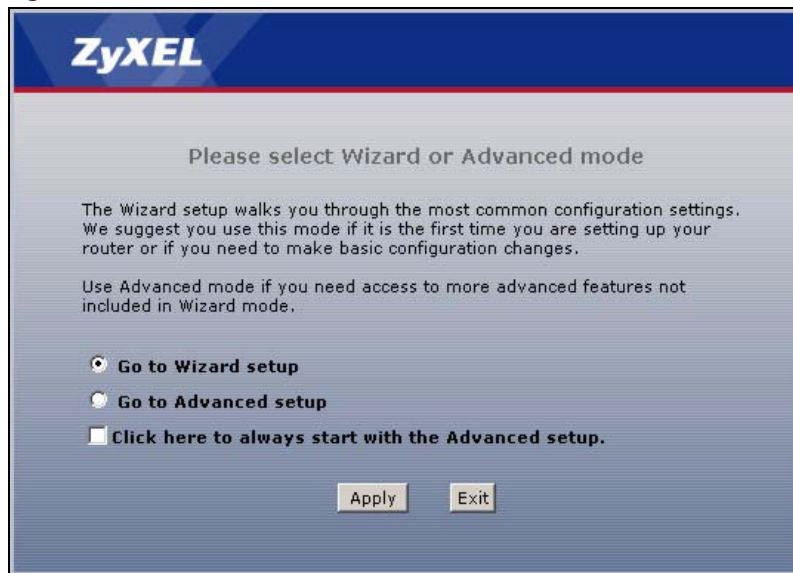
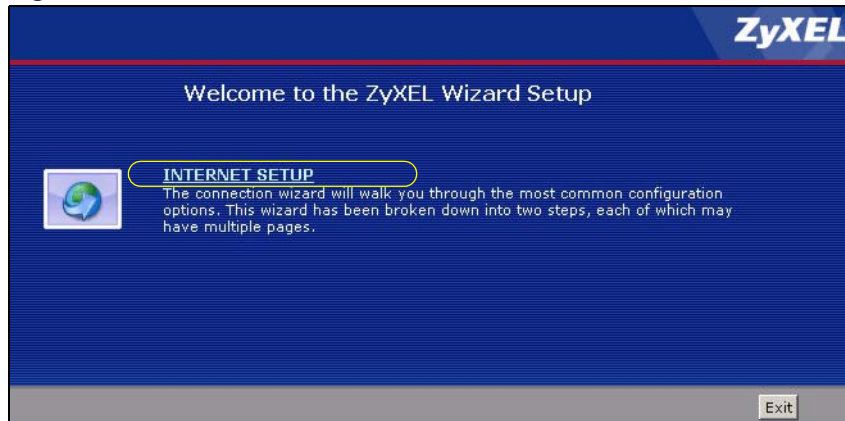
3 The wizard attempts to detect which WAN connection type you are using.

If the wizard detects your connection type and your ISP uses PPPoE or PPPoA, go to [Section 3.2.1 on page 42](#). The screen varies depending on the connection type you use.

If the wizard does not detect a connection type and the following screen appears (see [Figure 14 on page 41](#)), check your hardware connections and click **Restart the Internet Setup Wizard** to have the ZyXEL Device detect your connection again.

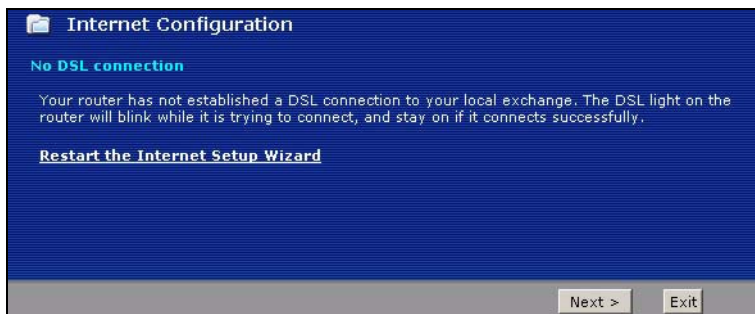
Figure 14 Auto Detection: No DSL Connection

If the wizard still cannot detect a connection type and the following screen appears (see [Figure 15 on page 42](#)), click **Next** and refer to [Section 3.2.2 on page 42](#) on how to configure the ZyXEL Device for Internet access manually.

Figure 15 Auto Detection: Failed

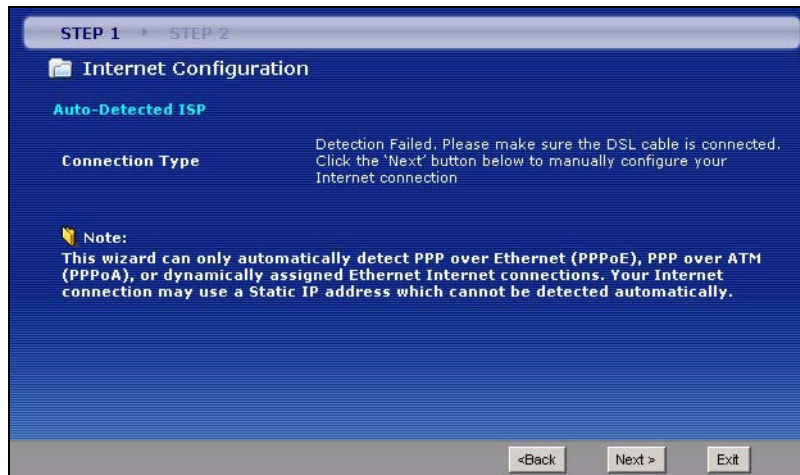

3.2.1 Automatic Detection

- 1 If you have a PPPoE or PPPoA connection, a screen displays prompting you to enter your Internet account information. Enter the username, password and/or service name exactly as provided.
- 2 Click **Next** to confirm your settings and test your connection.

Figure 16 Auto-Detection: PPPoE

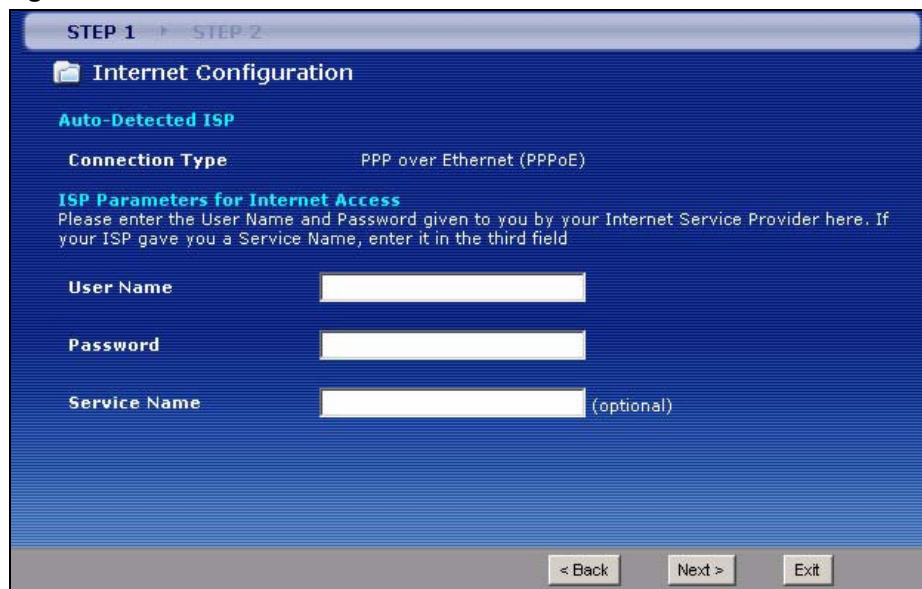

3.2.2 Manual Configuration

- 1 If the ZyXEL Device fails to detect your DSL connection type, enter the Internet access information given to you by your ISP exactly in the wizard screen. If not given, leave the fields set to the default.

Figure 17 Internet Access Wizard Setup: ISP Parameters

The following table describes the fields in this screen.

Table 7 Internet Access Wizard Setup: ISP Parameters

LABEL	DESCRIPTION
Mode	From the Mode drop-down list box, select Routing (default) if your ISP allows multiple computers to share an Internet account. Otherwise select Bridge .
Encapsulation	Select the encapsulation type your ISP uses from the Encapsulation drop-down list box. Choices vary depending on what you select in the Mode field. If you select Bridge in the Mode field, select either PPPoA or RFC 1483 . If you select Routing in the Mode field, select PPPoA , RFC 1483 , ENET ENCAP or PPPoE .
Multiplexing	Select the multiplexing method used by your ISP from the Multiplex drop-down list box either VC-based or LLC-based.
Virtual Circuit ID	VPI (Virtual Path Identifier) and VCI (Virtual Channel Identifier) define a virtual circuit. Refer to the appendix for more information.
VPI	Enter the VPI assigned to you. This field may already be configured.
VCI	Enter the VCI assigned to you. This field may already be configured.
Back	Click Back to go back to the previous screen.
Next	Click Next to continue to the next wizard screen. The next wizard screen you see depends on what protocol you chose above.
Exit	Click Exit to close the wizard screen without saving your changes.

- The next wizard screen varies depending on what mode and encapsulation type you use. All screens shown are with routing mode. Configure the fields and click **Next** to continue.

Figure 18 Internet Connection with PPPoE

STEP 1 > STEP 2

Internet Configuration

ISP Parameters for Internet Access
Please enter the User Name and Password given to you by your Internet Service Provider here. If your ISP gave you a Service Name, enter it in the third field

User Name

Password

Service Name (optional)

Note:
Device is automatically configured to obtain an IP address automatically. The ISP will assign you a different one each time you connect to the Internet.

< Back Apply Exit

The following table describes the fields in this screen.

Table 8 Internet Connection with PPPoE

LABEL	DESCRIPTION
User Name	Enter the user name exactly as your ISP assigned. If assigned a name in the form user@domain where domain identifies a service name, then enter both components exactly as given.
Password	Enter the password associated with the user name above.
Service Name	Type the name of your PPPoE service here.
Back	Click Back to go back to the previous wizard screen.
Apply	Click Apply to save your changes back to the ZyXEL Device.
Exit	Click Exit to close the wizard screen without saving your changes.

Figure 19 Internet Connection with RFC 1483

STEP 1 > STEP 2

Internet Configuration

ISP Parameters for Internet Access

IP Address

< Back Next > Exit

The following table describes the fields in this screen.

Table 9 Internet Connection with RFC 1483

LABEL	DESCRIPTION
IP Address	This field is available if you select Routing in the Mode field. Type your ISP assigned IP address in this field.
Back	Click Back to go back to the previous wizard screen.
Next	Click Next to continue to the next wizard screen.
Exit	Click Exit to close the wizard screen without saving your changes.

Figure 20 Internet Connection with ENET ENCAP



The following table describes the fields in this screen.

Table 10 Internet Connection with ENET ENCAP

LABEL	DESCRIPTION
Obtain an IP Address Automatically	A static IP address is a fixed IP that your ISP gives you. A dynamic IP address is not fixed; the ISP assigns you a different one each time you connect to the Internet. Select Obtain an IP Address Automatically if you have a dynamic IP address.
Static IP Address	Select Static IP Address if your ISP gives you a fixed IP address.
IP Address	Enter your ISP assigned IP address.
Subnet Mask	Enter a subnet mask in dotted decimal notation. Refer to the appendices to calculate a subnet mask If you are implementing subnetting.
Gateway IP address	You must specify a gateway IP address (supplied by your ISP) when you use ENET ENCAP in the Encapsulation field in the previous screen.
First DNS Server	Enter the IP addresses of the DNS servers. The DNS servers are passed to the DHCP clients along with the IP address and the subnet mask.

Table 10 Internet Connection with ENET ENCAP (continued)

LABEL	DESCRIPTION
Second DNS Server	As above.
Back	Click Back to go back to the previous wizard screen.
Apply	Click Apply to save your changes back to the ZyXEL Device.
Exit	Click Exit to close the wizard screen without saving your changes.

Figure 21 Internet Connection with PPPoA

STEP 1 | STEP 2

Internet Configuration

ISP Parameters for Internet Access
Please enter the User Name and Password given to you by your Internet Service Provider here

User Name

Password

Note:
Device is automatically configured to obtain an IP address automatically. The ISP will assign you a different one each time you connect to the Internet.

< Back Apply Exit

The following table describes the fields in this screen.

Table 11 Internet Connection with PPPoA

LABEL	DESCRIPTION
User Name	Enter the login name that your ISP gives you.
Password	Enter the password associated with the user name above.
Back	Click Back to go back to the previous wizard screen.
Apply	Click Apply to save your changes back to the ZyXEL Device.
Exit	Click Exit to close the wizard screen without saving your changes.

- If the user name and/or password you entered for PPPoE or PPPoA connection are not correct, the screen displays as shown next. Click **Back to Username and Password setup** to go back to the screen where you can modify them.

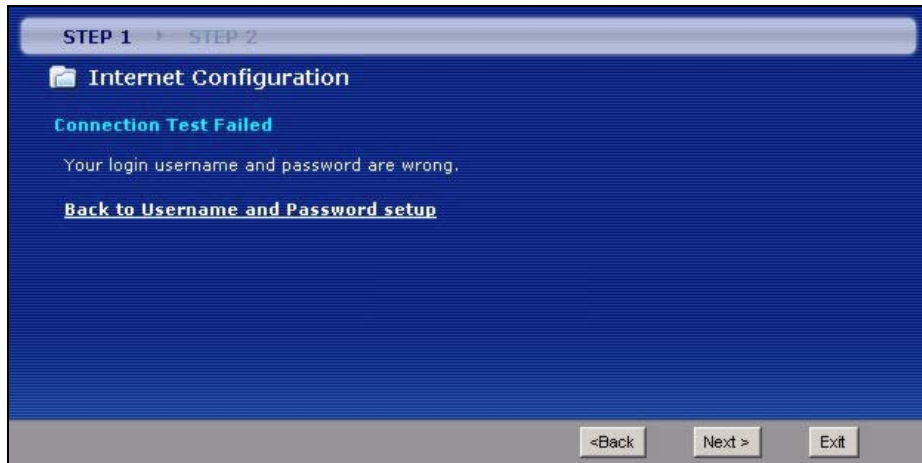
Figure 22 Connection Test Failed-1

- If the following screen displays, check if your account is activated or click **Restart the Internet Setup Wizard** to verify your Internet access settings.

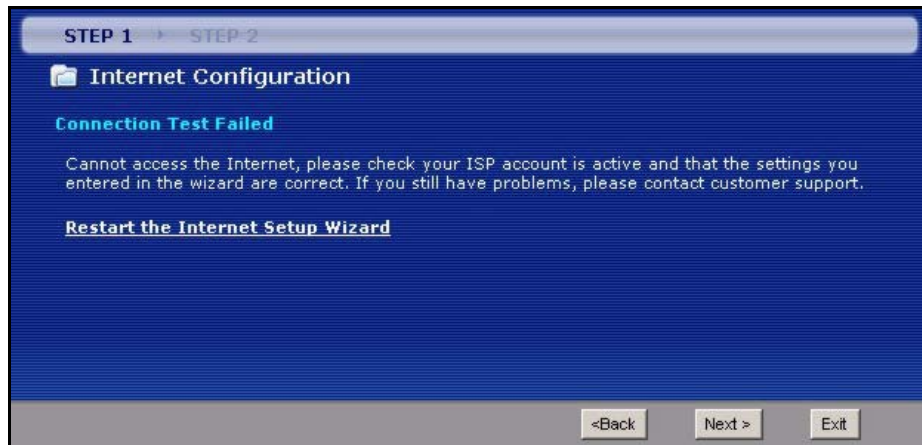
Figure 23 Connection Test Failed-2.

When you are finished with the Internet Setup Wizard the following screen displays your configuration details. Click **Finish** to exit the wizard.

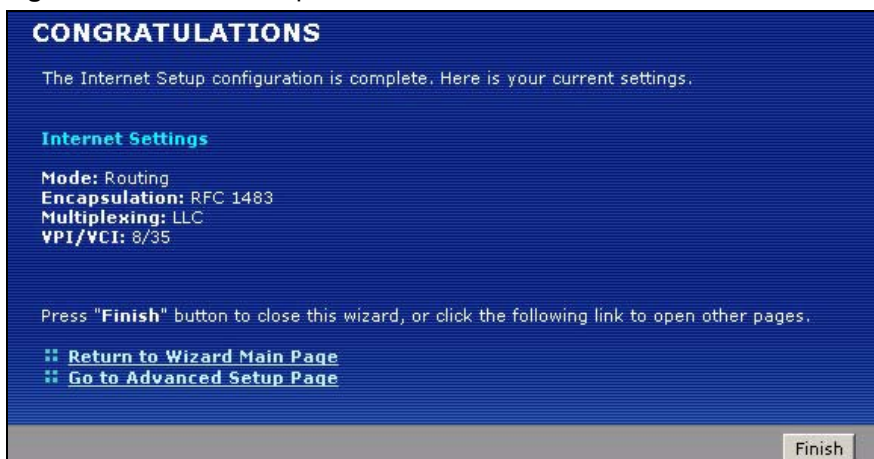
Figure 24 Internet Setup Wizard Finished

CHAPTER 4

WAN Setup

This chapter describes how to configure WAN settings.

4.1 WAN Overview

A WAN (Wide Area Network) is an outside connection to another network or the Internet.

4.1.1 Encapsulation

Be sure to use the encapsulation method required by your ISP. The ZyXEL Device supports the following methods.

4.1.1.1 ENET ENCAP

The MAC Encapsulated Routing Link Protocol (ENET ENCAP) is only implemented with the IP network protocol. IP packets are routed between the Ethernet interface and the WAN interface and then formatted so that they can be understood in a bridged environment. For instance, it encapsulates routed Ethernet frames into bridged ATM cells. ENET ENCAP requires that you specify a gateway IP address in the **ENET ENCAP Gateway** field in the second wizard screen. You can get this information from your ISP.

4.1.1.2 PPP over Ethernet

PPPoE (Point-to-Point Protocol over Ethernet) provides access control and billing functionality in a manner similar to dial-up services using PPP. PPPoE is an IETF standard (RFC 2516) specifying how a personal computer (PC) interacts with a broadband modem (DSL, cable, wireless, etc.) connection.

For the service provider, PPPoE offers an access and authentication method that works with existing access control systems (for example RADIUS).

One of the benefits of PPPoE is the ability to let you access one of multiple network services, a function known as dynamic service selection. This enables the service provider to easily create and offer new IP services for individuals.

Operationally, PPPoE saves significant effort for both you and the ISP or carrier, as it requires no specific configuration of the broadband modem at the customer site.

By implementing PPPoE directly on the ZyXEL Device (rather than individual computers), the computers on the LAN do not need PPPoE software installed, since the ZyXEL Device does that part of the task. Furthermore, with NAT, all of the LANs' computers will have access.

4.1.1.3 PPPoA

PPPoA stands for Point to Point Protocol over ATM Adaptation Layer 5 (AAL5). A PPPoA connection functions like a dial-up Internet connection. The ZyXEL Device encapsulates the PPP session based on RFC1483 and sends it through an ATM PVC (Permanent Virtual Circuit) to the Internet Service Provider's (ISP) DSLAM (digital access multiplexer). Please refer to RFC 2364 for more information on PPPoA. Refer to RFC 1661 for more information on PPP.

4.1.1.4 RFC 1483

RFC 1483 describes two methods for Multiprotocol Encapsulation over ATM Adaptation Layer 5 (AAL5). The first method allows multiplexing of multiple protocols over a single ATM virtual circuit (LLC-based multiplexing) and the second method assumes that each protocol is carried over a separate ATM virtual circuit (VC-based multiplexing). Please refer to the RFC for more detailed information.

4.1.2 Multiplexing

There are two conventions to identify what protocols the virtual circuit (VC) is carrying. Be sure to use the multiplexing method required by your ISP.

4.1.2.1 VC-based Multiplexing

In this case, by prior mutual agreement, each protocol is assigned to a specific virtual circuit; for example, VC1 carries IP, etc. VC-based multiplexing may be dominant in environments where dynamic creation of large numbers of ATM VCs is fast and economical.

4.1.2.2 LLC-based Multiplexing

In this case one VC carries multiple protocols with protocol identifying information being contained in each packet header. Despite the extra bandwidth and processing overhead, this method may be advantageous if it is not practical to have a separate VC for each carried protocol, for example, if charging heavily depends on the number of simultaneous VCs.

4.1.3 Encapsulation and Multiplexing Scenarios

For Internet access you should use the encapsulation and multiplexing methods used by your ISP. Consult your telephone company for information on encapsulation and multiplexing methods for LAN-to-LAN applications, for example between a branch office and corporate headquarters. There must be prior agreement on encapsulation and multiplexing methods

because they cannot be automatically determined. What method(s) you use also depends on how many VCs you have and how many different network protocols you need. The extra overhead that ENET ENCAP encapsulation entails makes it a poor choice in a LAN-to-LAN application. Here are some examples of more suitable combinations in such an application.

4.1.3.1 Scenario 1: One VC, Multiple Protocols

PPPoA (RFC-2364) encapsulation with **VC-based** multiplexing is the best combination because no extra protocol identifying headers are needed. The **PPP** protocol already contains this information.

4.1.3.2 Scenario 2: One VC, One Protocol (IP)

Selecting **RFC-1483** encapsulation with **VC-based** multiplexing requires the least amount of overhead (0 octets). However, if there is a potential need for multiple protocol support in the future, it may be safer to select **PPPoA** encapsulation instead of **RFC-1483**, so you do not need to reconfigure either computer later.

4.1.3.3 Scenario 3: Multiple VCs

If you have an equal number (or more) of VCs than the number of protocols, then select **RFC-1483** encapsulation and **VC-based** multiplexing.

4.1.4 VPI and VCI

Be sure to use the correct Virtual Path Identifier (VPI) and Virtual Channel Identifier (VCI) numbers assigned to you. The valid range for the VPI is 0 to 255 and for the VCI is 32 to 65535 (0 to 31 is reserved for local management of ATM traffic). Please see the appendix for more information.

4.1.5 IP Address Assignment

A static IP is a fixed IP that your ISP gives you. A dynamic IP is not fixed; the ISP assigns you a different one each time. The Single User Account feature can be enabled or disabled if you have either a dynamic or static IP. However the encapsulation method assigned influences your choices for IP address and ENET ENCAP gateway.

4.1.5.1 IP Assignment with PPPoA or PPPoE Encapsulation

If you have a dynamic IP, then the **IP Address** and **ENET ENCAP Gateway** fields are not applicable (N/A). If you have a static IP, then you *only* need to fill in the **IP Address** field and *not* the **ENET ENCAP Gateway** field.

4.1.5.2 IP Assignment with RFC 1483 Encapsulation

In this case the IP Address Assignment *must* be static with the same requirements for the **IP Address** and **ENET ENCAP Gateway** fields as stated above.

4.1.5.3 IP Assignment with ENET ENCAP Encapsulation

In this case you can have either a static or dynamic IP. For a static IP you must fill in all the **IP Address** and **ENET ENCAP Gateway** fields as supplied by your ISP. However for a dynamic IP, the ZyXEL Device acts as a DHCP client on the WAN port and so the **IP Address** and **ENET ENCAP Gateway** fields are not applicable (N/A) as the DHCP server assigns them to the ZyXEL Device.

4.1.6 Nailed-Up Connection (PPP)

A nailed-up connection is a dial-up line where the connection is always up regardless of traffic demand. The ZyXEL Device does two things when you specify a nailed-up connection. The first is that idle timeout is disabled. The second is that the ZyXEL Device will try to bring up the connection when turned on and whenever the connection is down. A nailed-up connection can be very expensive for obvious reasons.

Do not specify a nailed-up connection unless your telephone company offers flat-rate service or you need a constant connection and the cost is of no concern

4.1.7 NAT

NAT (Network Address Translation - NAT, RFC 1631) is the translation of the IP address of a host in a packet, for example, the source address of an outgoing packet, used within one network to a different IP address known within another network.

4.2 Metric

The metric represents the "cost of transmission". A router determines the best route for transmission by choosing a path with the lowest "cost". RIP routing uses hop count as the measurement of cost, with a minimum of "1" for directly connected networks. The number must be between "1" and "15"; a number greater than "15" means the link is down. The smaller the number, the lower the "cost".

The metric sets the priority for the ZyXEL Device's routes to the Internet. If any two of the default routes have the same metric, the ZyXEL Device uses the following pre-defined priorities:

- Normal route: designated by the ISP (see [Section 4.5 on page 54](#))
- Traffic-redirect route (see [Section 4.7 on page 62](#))
- WAN-backup route, also called dial-backup (see [Section 4.8 on page 63](#))

For example, if the normal route has a metric of "1" and the traffic-redirect route has a metric of "2" and dial-backup route has a metric of "3", then the normal route acts as the primary default route. If the normal route fails to connect to the Internet, the ZyXEL Device tries the traffic-redirect route next. In the same manner, the ZyXEL Device uses the dial-backup route if the traffic-redirect route also fails.

If you want the dial-backup route to take first priority over the traffic-redirect route or even the normal route, all you need to do is set the dial-backup route's metric to "1" and the others to "2" (or greater).

IP Policy Routing overrides the default routing behavior and takes priority over all of the routes mentioned above.

4.3 Traffic Shaping

Traffic Shaping is an agreement between the carrier and the subscriber to regulate the average rate and fluctuations of data transmission over an ATM network. This agreement helps eliminate congestion, which is important for transmission of real time data such as audio and video connections.

Peak Cell Rate (PCR) is the maximum rate at which the sender can send cells. This parameter may be lower (but not higher) than the maximum line speed. 1 ATM cell is 53 bytes (424 bits), so a maximum speed of 832Kbps gives a maximum PCR of 1962 cells/sec. This rate is not guaranteed because it is dependent on the line speed.

Sustained Cell Rate (SCR) is the mean cell rate of each bursty traffic source. It specifies the maximum average rate at which cells can be sent over the virtual connection. SCR may not be greater than the PCR.

Maximum Burst Size (MBS) is the maximum number of cells that can be sent at the PCR. After MBS is reached, cell rates fall below SCR until cell rate averages to the SCR again. At this time, more cells (up to the MBS) can be sent at the PCR again.

If the PCR, SCR or MBS is set to the default of "0", the system will assign a maximum value that correlates to your upstream line rate.

The following figure illustrates the relationship between PCR, SCR and MBS.

Figure 25 Example of Traffic Shaping

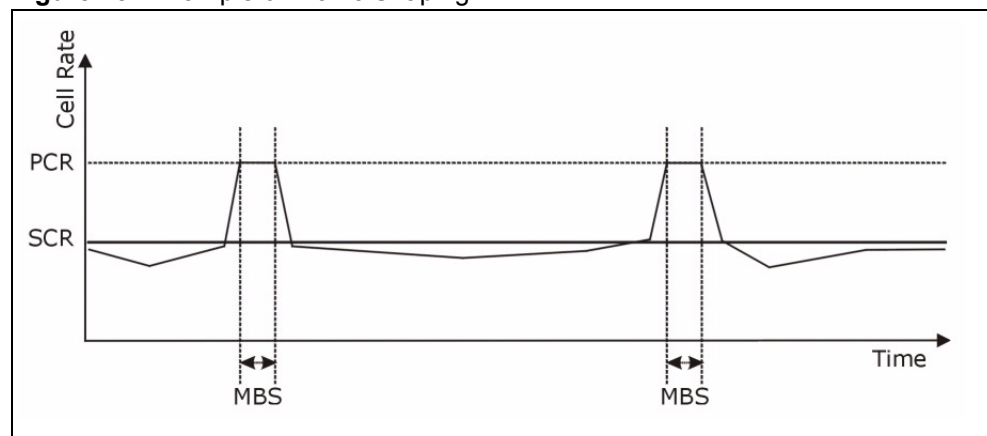

4.3.1 ATM Traffic Classes

These are the basic ATM traffic classes defined by the ATM Forum Traffic Management 4.0 Specification.

4.3.1.1 Constant Bit Rate (CBR)

Constant Bit Rate (CBR) provides fixed bandwidth that is always available even if no data is being sent. CBR traffic is generally time-sensitive (doesn't tolerate delay). CBR is used for connections that continuously require a specific amount of bandwidth. A PCR is specified and if traffic exceeds this rate, cells may be dropped. Examples of connections that need CBR would be high-resolution video and voice.

4.3.1.2 Variable Bit Rate (VBR)

The Variable Bit Rate (VBR) ATM traffic class is used with bursty connections. Connections that use the Variable Bit Rate (VBR) traffic class can be grouped into real time (VBR-RT) or non-real time (VBR-nRT) connections.

The VBR-RT (real-time Variable Bit Rate) type is used with bursty connections that require closely controlled delay and delay variation. It also provides a fixed amount of bandwidth (a PCR is specified) but is only available when data is being sent. An example of an VBR-RT connection would be video conferencing. Video conferencing requires real-time data transfers and the bandwidth requirement varies in proportion to the video image's changing dynamics.

The VBR-nRT (non real-time Variable Bit Rate) type is used with bursty connections that do not require closely controlled delay and delay variation. It is commonly used for "bursty" traffic typical on LANs. PCR and MBS define the burst levels, SCR defines the minimum level. An example of an VBR-nRT connection would be non-time sensitive data file transfers.

4.3.1.3 Unspecified Bit Rate (UBR)

The Unspecified Bit Rate (UBR) ATM traffic class is for bursty data transfers. However, UBR doesn't guarantee any bandwidth and only delivers traffic when the network has spare bandwidth. An example application is background file transfer.

4.4 Zero Configuration Internet Access

Once you turn on and connect the ZyXEL Device to a telephone jack, it automatically detects the Internet connection settings (such as the VCI/VPI numbers and the encapsulation method) from the ISP and makes the necessary configuration changes. In cases where additional account information (such as an Internet account user name and password) is required or the ZyXEL Device cannot connect to the ISP, you will be redirected to web screen(s) for information input or troubleshooting.

Zero configuration for Internet access is disable when

- the ZyXEL Device is in bridge mode
- you set the ZyXEL Device to use a static (fixed) WAN IP address.

4.5 Internet Connection

To change your ZyXEL Device's WAN Internet access settings, click **Network > WAN**. The screen differs by the encapsulation.

See [Section 4.1 on page 48](#) for more information.

Figure 26 Internet Connection (PPPoE)

The following table describes the labels in this screen.

Table 12 Internet Connection

LABEL	DESCRIPTION
General	
Name	Enter the name of your Internet Service Provider, e.g., MyISP. This information is for identification purposes only.
Mode	Select Routing (default) from the drop-down list box if your ISP allows multiple computers to share an Internet account. Otherwise select Bridge .

Table 12 Internet Connection (continued)

LABEL	DESCRIPTION
Encapsulation	Select the method of encapsulation used by your ISP from the drop-down list box. Choices vary depending on the mode you select in the Mode field. If you select Bridge in the Mode field, select either PPPoA or RFC 1483 . If you select Routing in the Mode field, select PPPoA , RFC 1483 , ENET ENCAP or PPPoE .
User Name	(PPPoA and PPPoE encapsulation only) Enter the user name exactly as your ISP assigned. If assigned a name in the form user@domain where domain identifies a service name, then enter both components exactly as given.
Password	(PPPoA and PPPoE encapsulation only) Enter the password associated with the user name above.
Service Name	(PPPoE only) Type the name of your PPPoE service here.
Multiplexing	Select the method of multiplexing used by your ISP from the drop-down list. Choices are VC or LLC .
Virtual Circuit ID	VPI (Virtual Path Identifier) and VCI (Virtual Channel Identifier) define a virtual circuit. Refer to the appendix for more information.
VPI	The valid range for the VPI is 0 to 255. Enter the VPI assigned to you.
VCI	The valid range for the VCI is 32 to 65535 (0 to 31 is reserved for local management of ATM traffic). Enter the VCI assigned to you.
IP Address	This option is available if you select Routing in the Mode field. A static IP address is a fixed IP that your ISP gives you. A dynamic IP address is not fixed; the ISP assigns you a different one each time you connect to the Internet. If you use the encapsulation type except RFC 1483 , select Obtain an IP Address Automatically when you have a dynamic IP address; otherwise select Static IP Address and type your ISP assigned IP address in the IP Address field below. If you use RFC 1483 , enter the IP address given by your ISP in the IP Address field.
Subnet Mask (ENET ENCAP encapsulation only)	Enter a subnet mask in dotted decimal notation. Refer to the appendices to calculate a subnet mask If you are implementing subnetting.
Gateway IP address (ENET ENCAP encapsulation only)	You must specify a gateway IP address (supplied by your ISP) when you select ENET ENCAP in the Encapsulation field
Connection (PPPoA and PPPoE encapsulation only)	
Nailed-Up Connection	Select Nailed-Up Connection when you want your connection up all the time. The ZyXEL Device will try to bring up the connection automatically if it is disconnected.
Connect on Demand	Select Connect on Demand when you don't want the connection up all the time and specify an idle time-out in the Max Idle Timeout field.
Max Idle Timeout	Specify an idle time-out in the Max Idle Timeout field when you select Connect on Demand . The default setting is 0, which means the Internet session will not timeout.
Apply	Click Apply to save the changes.

Table 12 Internet Connection (continued)

LABEL	DESCRIPTION
Cancel	Click Cancel to begin configuring this screen afresh.
Advanced Setup	Click this button to display the Advanced Internet Connection Setup screen and edit more details of your WAN setup.

4.5.1 Configuring Advanced Internet Connection Setup

To edit your ZyXEL Device's advanced WAN settings, click the **Advanced Setup** button in the **Internet Connection** screen. The screen appears as shown.

Figure 27 Advanced Internet Connection Setup

The following table describes the labels in this screen.

Table 13 Advanced Internet Connection Setup

LABEL	DESCRIPTION
RIP & Multicast Setup	
RIP Direction	Select the RIP direction from None , Both , In Only and Out Only .
RIP Version	Select the RIP version from RIP-1 , RIP-2B and RIP-2M .
Multicast	IGMP (Internet Group Multicast Protocol) is a network-layer protocol used to establish membership in a multicast group. The ZyXEL Device supports both IGMP version 1 (IGMP-v1) and IGMP-v2 . Select None to disable it.
ATM QoS	

Table 13 Advanced Internet Connection Setup (continued)

LABEL	DESCRIPTION
ATM QoS Type	Select CBR (Continuous Bit Rate) to specify fixed (always-on) bandwidth for voice or data traffic. Select UBR (Unspecified Bit Rate) for applications that are non-time sensitive, such as e-mail. Select VBR-nRT (Variable Bit Rate-non Real Time) or VBR-RT (Variable Bit Rate-Real Time) for bursty traffic and bandwidth sharing with other applications.
Peak Cell Rate	Divide the DSL line rate (bps) by 424 (the size of an ATM cell) to find the Peak Cell Rate (PCR). This is the maximum rate at which the sender can send cells. Type the PCR here.
Sustain Cell Rate	The Sustain Cell Rate (SCR) sets the average cell rate (long-term) that can be transmitted. Type the SCR, which must be less than the PCR. Note that system default is 0 cells/sec.
Maximum Burst Size	Maximum Burst Size (MBS) refers to the maximum number of cells that can be sent at the peak rate. Type the MBS, which is less than 65535.
Zero Configuration	This feature is not applicable/available when you configure the ZyXEL Device to use a static WAN IP address or in bridge mode. Select Yes to set the ZyXEL Device to automatically detect the Internet connection settings (such as the VCI/VPI numbers and the encapsulation method) from the ISP and make the necessary configuration changes. Select No to disable this feature. You must manually configure the ZyXEL Device for Internet access.
PPPoE Passthrough (PPPoE encapsulation only)	This field is available when you select PPPoE encapsulation. In addition to the ZyXEL Device's built-in PPPoE client, you can enable PPPoE pass through to allow up to ten hosts on the LAN to use PPPoE client software on their computers to connect to the ISP via the ZyXEL Device. Each host can have a separate account and a public WAN IP address. PPPoE pass through is an alternative to NAT for application where NAT is not appropriate. Disable PPPoE pass through if you do not need to allow hosts on the LAN to use PPPoE client software on their computers to connect to the ISP.
Back	Click Back to return to the previous screen.
Apply	Click Apply to save the changes.
Cancel	Click Cancel to begin configuring this screen afresh.

4.6 Configuring More Connections

This section describes the protocol-independent parameters for a remote network. They are required for placing calls to a remote gateway and the network behind it across a WAN connection. When you use the **WAN > Internet Connection** screen to set up Internet access, you are configuring the first WAN connection.

Click **Network > WAN > More Connections** to display the screen as shown next.

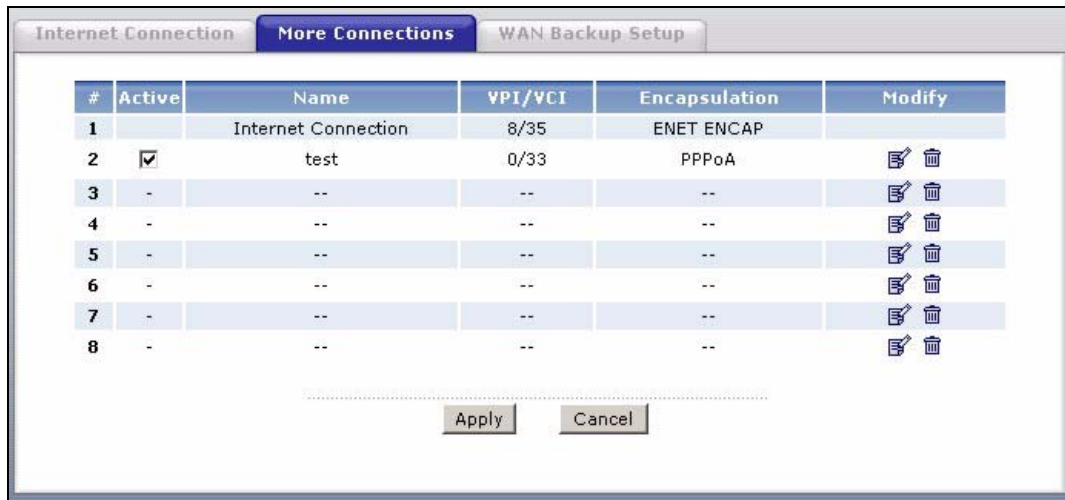
Figure 28 More Connections

The following table describes the labels in this screen.

Table 14 More Connections

LABEL	DESCRIPTION
#	This is the index number of a connection.
Active	This display whether this connection is activated. Clear the check box to disable the connection. Select the check box to enable it.
Name	This is the descriptive name for this connection.
VPI/VCI	This is the VPI and VCI values used for this connection.
Encapsulation	This is the method of encapsulation used for this connection.
Modify	The first (ISP) connection is read-only in this screen. Use the WAN > Internet Connection screen to edit it. Click the edit icon to go to the screen where you can edit the connection. Click the delete icon to remove an existing connection. You cannot remove the first connection.
Apply	Click Apply to save the changes.
Cancel	Click Cancel to begin configuring this screen afresh.

4.6.1 More Connections Edit

Click the edit icon in the **More Connections** screen to configure a connection.

Figure 29 More Connections Edit

The following table describes the labels in this screen.

Table 15 More Connections Edit

LABEL	DESCRIPTION
Active	Select the check box to activate or clear the check box to deactivate this connection.
Name	Enter a unique, descriptive name of up to 13 ASCII characters for this connection.
Mode	Select Routing from the drop-down list box if your ISP allows multiple computers to share an Internet account. If you select Bridge , the ZyXEL Device will forward any packet that it does not route to this remote node; otherwise, the packets are discarded.
Encapsulation	Select the method of encapsulation used by your ISP from the drop-down list box. Choices are PPPoA , RFC 1483 , ENET ENCAP or PPPoE .

Table 15 More Connections Edit (continued)

LABEL	DESCRIPTION
User Name	(PPPoA and PPPoE encapsulation only) Enter the user name exactly as your ISP assigned. If assigned a name in the form user@domain where domain identifies a service name, then enter both components exactly as given.
Password	(PPPoA and PPPoE encapsulation only) Enter the password associated with the user name above.
Service Name	(PPPoE only) Type the name of your PPPoE service here.
Multiplexing	<p>Select the method of multiplexing used by your ISP from the drop-down list. Choices are VC or LLC.</p> <p>By prior agreement, a protocol is assigned a specific virtual circuit, for example, VC1 will carry IP. If you select VC, specify separate VPI and VCI numbers for each protocol.</p> <p>For LLC-based multiplexing or PPP encapsulation, one VC carries multiple protocols with protocol identifying information being contained in each packet header. In this case, only one set of VPI and VCI numbers need be specified for all protocols.</p>
VPI	The valid range for the VPI is 0 to 255. Enter the VPI assigned to you.
VCI	The valid range for the VCI is 32 to 65535 (0 to 31 is reserved for local management of ATM traffic). Enter the VCI assigned to you.
IP Address	<p>This option is available if you select Routing in the Mode field.</p> <p>A static IP address is a fixed IP that your ISP gives you. A dynamic IP address is not fixed; the ISP assigns you a different one each time you connect to the Internet.</p> <p>If you use the encapsulation type except RFC 1483, select Obtain an IP Address Automatically when you have a dynamic IP address; otherwise select Static IP Address and type your ISP assigned IP address in the IP Address field below.</p> <p>If you use RFC 1483, enter the IP address given by your ISP in the IP Address field.</p>
Subnet Mask	<p>Enter a subnet mask in dotted decimal notation.</p> <p>Refer to the appendices to calculate a subnet mask If you are implementing subnetting.</p>
Gateway IP address	Specify a gateway IP address (supplied by your ISP).
Connection	
Nailed-Up Connection	Select Nailed-Up Connection when you want your connection up all the time. The ZyXEL Device will try to bring up the connection automatically if it is disconnected.
Connect on Demand	Select Connect on Demand when you don't want the connection up all the time and specify an idle time-out in the Max Idle Timeout field.
Max Idle Timeout	Specify an idle time-out in the Max Idle Timeout field when you select Connect on Demand . The default setting is 0, which means the Internet session will not timeout.
NAT	<p>SUA only is available only when you select Routing in the Mode field.</p> <p>Select SUA Only if you have one public IP address and want to use NAT. Click Edit to go to the Port Forwarding screen to edit a server mapping set.</p> <p>Otherwise, select None to disable NAT.</p>
Back	Click Back to return to the previous screen.
Apply	Click Apply to save the changes.

Table 15 More Connections Edit (continued)

LABEL	DESCRIPTION
Cancel	Click Cancel to begin configuring this screen afresh.
Advanced Setup	Click this button to display the More Connections Advanced screen and edit more details of your WAN setup.

4.6.2 Configuring More Connections Advanced Setup

To edit your ZyXEL Device's advanced WAN settings, click the **Advanced Setup** button in the **More Connections Edit** screen. The screen appears as shown.

Figure 30 More Connections Advanced Setup

The following table describes the labels in this screen.

Table 16 More Connections Advanced Setup

LABEL	DESCRIPTION
RIP & Multicast Setup	
RIP Direction	Select the RIP direction from None , Both , In Only and Out Only .
RIP Version	Select the RIP version from RIP-1 , RIP-2B and RIP-2M .
Multicast	IGMP (Internet Group Multicast Protocol) is a network-layer protocol used to establish membership in a multicast group. The ZyXEL Device supports both IGMP version 1 (IGMP-v1) and IGMP-v2 . Select None to disable it.
ATM QoS	
ATM QoS Type	Select CBR (Continuous Bit Rate) to specify fixed (always-on) bandwidth for voice or data traffic. Select UBR (Unspecified Bit Rate) for applications that are non-time sensitive, such as e-mail. Select VBR-nRT (Variable Bit Rate-non Real Time) or VBR-RT (Variable Bit Rate-Real Time) for bursty traffic and bandwidth sharing with other applications.

Table 16 More Connections Advanced Setup (continued)

LABEL	DESCRIPTION
Peak Cell Rate	Divide the DSL line rate (bps) by 424 (the size of an ATM cell) to find the Peak Cell Rate (PCR). This is the maximum rate at which the sender can send cells. Type the PCR here.
Sustain Cell Rate	The Sustain Cell Rate (SCR) sets the average cell rate (long-term) that can be transmitted. Type the SCR, which must be less than the PCR. Note that system default is 0 cells/sec.
Maximum Burst Size	Maximum Burst Size (MBS) refers to the maximum number of cells that can be sent at the peak rate. Type the MBS, which is less than 65535.
Back	Click Back to return to the previous screen.
Apply	Click Apply to save the changes.
Cancel	Click Cancel to begin configuring this screen afresh.

4.7 Traffic Redirect

Traffic redirect forwards traffic to a backup gateway when the ZyXEL Device cannot connect to the Internet. An example is shown in the figure below.

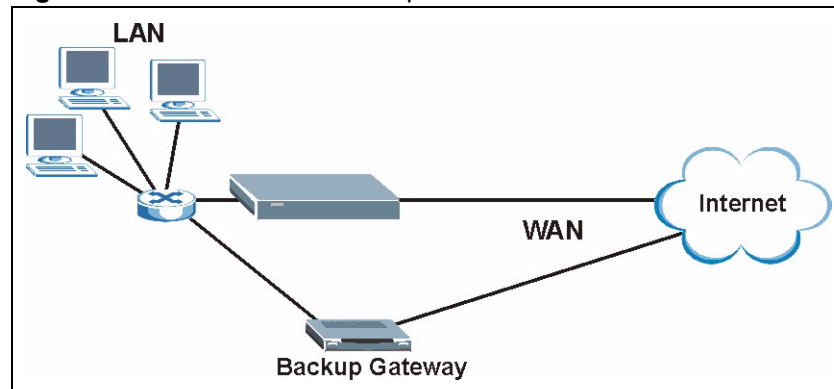
Figure 31 Traffic Redirect Example

The following network topology allows you to avoid triangle route security issues when the backup gateway is connected to the LAN. Use IP alias to configure the LAN into two or three logical networks with the ZyXEL Device itself as the gateway for each LAN network. Put the protected LAN in one subnet (Subnet 1 in the following figure) and the backup gateway in another subnet (Subnet 2). Configure filters that allow packets from the protected LAN (Subnet 1) to the backup gateway (Subnet 2).

Figure 32 Traffic Redirect LAN Setup

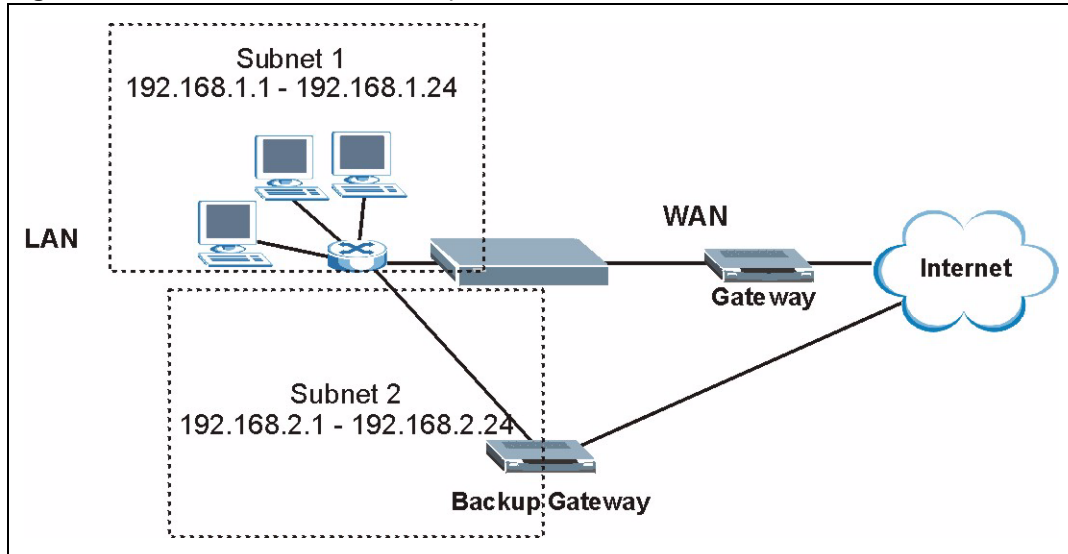

4.8 Configuring WAN Backup

To change your ZyXEL Device's WAN backup settings, click **Network > WAN > WAN Backup Setup**. The screen appears as shown.

Figure 33 WAN Backup Setup

The screenshot shows the 'WAN Backup Setup' configuration window. It features three tabs: 'Internet Connection', 'More Connections', and 'WAN Backup Setup'. The 'WAN Backup Setup' section contains the following fields:

- Backup Type:** A dropdown menu set to 'DSL Link'.
- Check WAN IP Address 1:** Text input field containing '0.0.0.0'.
- Check WAN IP Address 2:** Text input field containing '0.0.0.0'.
- Check WAN IP Address 3:** Text input field containing '0.0.0.0'.
- Fail Tolerance:** Text input field containing '0'.
- Recovery Interval:** Text input field containing '0' followed by 'sec'.
- Timeout:** Text input field containing '0' followed by 'sec'.

The 'Traffic Redirect' section includes:

- Active Traffic Redirect:** A checkbox that is currently unchecked.
- Metric:** Text input field containing '15'.
- Backup Gateway:** Text input field containing '0.0.0.0'.

At the bottom of the window, there are 'Apply' and 'Cancel' buttons.

The following table describes the labels in this screen.

Table 17 WAN Backup Setup

LABEL	DESCRIPTION
Backup Type	Select the method that the ZyXEL Device uses to check the DSL connection. Select DSL Link to have the ZyXEL Device check if the connection to the DSLAM is up. Select ICMP to have the ZyXEL Device periodically ping the IP addresses configured in the Check WAN IP Address fields.
Check WAN IP Address1-3	Configure this field to test your ZyXEL Device's WAN accessibility. Type the IP address of a reliable nearby computer (for example, your ISP's DNS server address). Note: If you activate either traffic redirect or dial backup, you must configure at least one IP address here. When using a WAN backup connection, the ZyXEL Device periodically pings the addresses configured here and uses the other WAN backup connection (if configured) if there is no response.
Fail Tolerance	Type the number of times (2 recommended) that your ZyXEL Device may ping the IP addresses configured in the Check WAN IP Address field without getting a response before switching to a WAN backup connection (or a different WAN backup connection).
Recovery Interval	When the ZyXEL Device is using a lower priority connection (usually a WAN backup connection), it periodically checks to whether or not it can use a higher priority connection. Type the number of seconds (30 recommended) for the ZyXEL Device to wait between checks. Allow more time if your destination IP address handles lots of traffic.
Timeout	Type the number of seconds (3 recommended) for your ZyXEL Device to wait for a ping response from one of the IP addresses in the Check WAN IP Address field before timing out the request. The WAN connection is considered "down" after the ZyXEL Device times out the number of times specified in the Fail Tolerance field. Use a higher value in this field if your network is busy or congested.
Traffic Redirect	Traffic redirect forwards traffic to a backup gateway when the ZyXEL Device cannot connect to the Internet.
Active Traffic Redirect	Select this check box to have the ZyXEL Device use traffic redirect if the normal WAN connection goes down. Note: If you activate traffic redirect, you must configure at least one Check WAN IP Address.
Metric	This field sets this route's priority among the routes the ZyXEL Device uses. The metric represents the "cost of transmission". A router determines the best route for transmission by choosing a path with the lowest "cost". RIP routing uses hop count as the measurement of cost, with a minimum of "1" for directly connected networks. The number must be between "1" and "15"; a number greater than "15" means the link is down. The smaller the number, the lower the "cost".
Backup Gateway	Type the IP address of your backup gateway in dotted decimal notation. The ZyXEL Device automatically forwards traffic to this IP address if the ZyXEL Device's Internet connection terminates.
Apply	Click Apply to save the changes.
Cancel	Click Cancel to begin configuring this screen afresh.

CHAPTER 5

LAN Setup

This chapter describes how to configure LAN settings.

5.1 LAN Overview

A Local Area Network (LAN) is a shared communication system to which many computers are attached. A LAN is a computer network limited to the immediate area, usually the same building or floor of a building. The LAN screens can help you configure a LAN DHCP server and manage IP addresses.

See [Section 5.3 on page 72](#) to configure the LAN screens.

5.1.1 LANs, WANs and the ZyXEL Device

The actual physical connection determines whether the ZyXEL Device ports are LAN or WAN ports. There are two separate IP networks, one inside the LAN network and the other outside the WAN network as shown next.

Figure 34 LAN and WAN IP Addresses

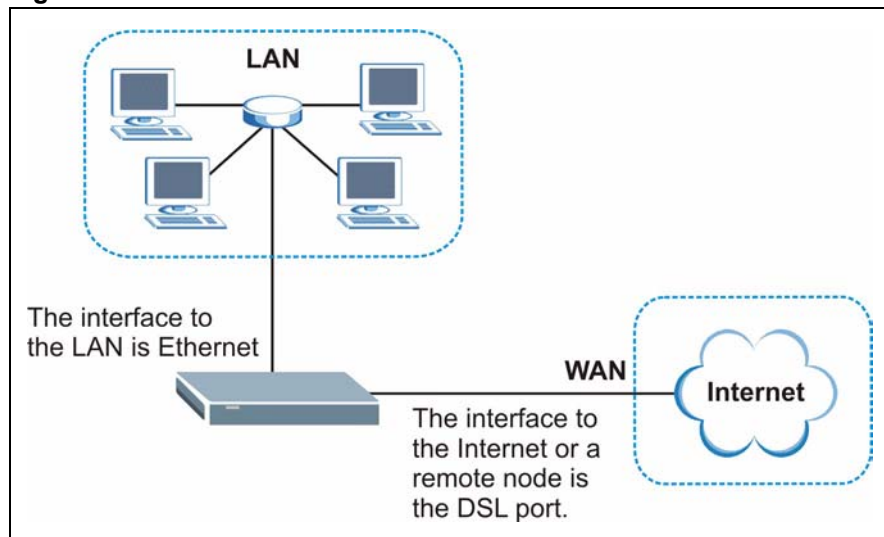

5.1.2 DHCP Setup

DHCP (Dynamic Host Configuration Protocol, RFC 2131 and RFC 2132) allows individual clients to obtain TCP/IP configuration at start-up from a server. You can configure the ZyXEL Device as a DHCP server or disable it. When configured as a server, the ZyXEL Device provides the TCP/IP configuration for the clients. If you turn DHCP service off, you must have another DHCP server on your LAN, or else the computer must be manually configured.

5.1.2.1 IP Pool Setup

The ZyXEL Device is pre-configured with a pool of IP addresses for the DHCP clients (DHCP Pool). See the product specifications in the appendices. Do not assign static IP addresses from the DHCP pool to your LAN computers.

5.1.3 DNS Server Address

DNS (Domain Name System) is for mapping a domain name to its corresponding IP address and vice versa. The DNS server is extremely important because without it, you must know the IP address of a machine before you can access it. The DNS server addresses that you enter in the DHCP setup are passed to the client machines along with the assigned IP address and subnet mask.

There are two ways that an ISP disseminates the DNS server addresses. The first is for an ISP to tell a customer the DNS server addresses, usually in the form of an information sheet, when s/he signs up. If your ISP gives you the DNS server addresses, enter them in the **DNS Server** fields in **DHCP Setup**, otherwise, leave them blank.

Some ISP's choose to pass the DNS servers using the DNS server extensions of PPP IPCP (IP Control Protocol) after the connection is up. If your ISP did not give you explicit DNS servers, chances are the DNS servers are conveyed through IPCP negotiation. The ZyXEL Device supports the IPCP DNS server extensions through the DNS proxy feature.

If the **Primary** and **Secondary DNS Server** fields in the **DHCP Setup** screen are not specified, for instance, left as **0.0.0.0**, the ZyXEL Device tells the DHCP clients that it itself is the DNS server. When a computer sends a DNS query to the ZyXEL Device, the ZyXEL Device forwards the query to the real DNS server learned through IPCP and relays the response back to the computer.

Please note that DNS proxy works only when the ISP uses the IPCP DNS server extensions. It does not mean you can leave the DNS servers out of the DHCP setup under all circumstances. If your ISP gives you explicit DNS servers, make sure that you enter their IP addresses in the **DHCP Setup** screen. This way, the ZyXEL Device can pass the DNS servers to the computers and the computers can query the DNS server directly without the ZyXEL Device's intervention.

5.1.4 DNS Server Address Assignment

Use DNS (Domain Name System) to map a domain name to its corresponding IP address and vice versa. The DNS server is extremely important because without it, you must know the IP address of a computer before you can access it.

There are two ways that an ISP disseminates the DNS server addresses.

- The ISP tells you the DNS server addresses, usually in the form of an information sheet, when you sign up. If your ISP gives you DNS server addresses, enter them in the DNS Server fields in the **DHCP Setup** screen.
- The ZyXEL Device acts as a DNS proxy when the **Primary** and **Secondary DNS Server** fields are left as **0.0.0.0** in the **DHCP Setup** screen.

5.2 LAN TCP/IP

The ZyXEL Device has built-in DHCP server capability that assigns IP addresses and DNS servers to systems that support DHCP client capability.

5.2.1 IP Address and Subnet Mask

Similar to the way houses on a street share a common street name, so too do computers on a LAN share one common network number.

Where you obtain your network number depends on your particular situation. If the ISP or your network administrator assigns you a block of registered IP addresses, follow their instructions in selecting the IP addresses and the subnet mask.

If the ISP did not explicitly give you an IP network number, then most likely you have a single user account and the ISP will assign you a dynamic IP address when the connection is established. If this is the case, it is recommended that you select a network number from 192.168.0.0 to 192.168.255.0 and you must enable the Network Address Translation (NAT) feature of the ZyXEL Device. The Internet Assigned Number Authority (IANA) reserved this block of addresses specifically for private use; please do not use any other number unless you are told otherwise. Let's say you select 192.168.1.0 as the network number; which covers 254 individual addresses, from 192.168.1.1 to 192.168.1.254 (zero and 255 are reserved). In other words, the first three numbers specify the network number while the last number identifies an individual computer on that network.

Once you have decided on the network number, pick an IP address that is easy to remember, for instance, 192.168.1.1, for your ZyXEL Device, but make sure that no other device on your network is using that IP address.

The subnet mask specifies the network number portion of an IP address. Your ZyXEL Device will compute the subnet mask automatically based on the IP address that you entered. You don't need to change the subnet mask computed by the ZyXEL Device unless you are instructed to do otherwise.

5.2.1.1 Private IP Addresses

Every machine on the Internet must have a unique address. If your networks are isolated from the Internet, for example, only between your two branch offices, you can assign any IP addresses to the hosts without problems. However, the Internet Assigned Numbers Authority (IANA) has reserved the following three blocks of IP addresses specifically for private networks:

- 10.0.0.0 — 10.255.255.255
- 172.16.0.0 — 172.31.255.255
- 192.168.0.0 — 192.168.255.255

You can obtain your IP address from the IANA, from an ISP or it can be assigned from a private network. If you belong to a small organization and your Internet access is through an ISP, the ISP can provide you with the Internet addresses for your local networks. On the other hand, if you are part of a much larger organization, you should consult your network administrator for the appropriate IP addresses.

Note: Regardless of your particular situation, do not create an arbitrary IP address; always follow the guidelines above. For more information on address assignment, please refer to RFC 1597, *Address Allocation for Private Internets* and RFC 1466, *Guidelines for Management of IP Address Space*.

5.2.2 RIP Setup

RIP (Routing Information Protocol) allows a router to exchange routing information with other routers. The **RIP Direction** field controls the sending and receiving of RIP packets. When set to:

- **Both** - the ZyXEL Device will broadcast its routing table periodically and incorporate the RIP information that it receives.
- **In Only** - the ZyXEL Device will not send any RIP packets but will accept all RIP packets received.
- **Out Only** - the ZyXEL Device will send out RIP packets but will not accept any RIP packets received.
- **None** - the ZyXEL Device will not send any RIP packets and will ignore any RIP packets received.

The **Version** field controls the format and the broadcasting method of the RIP packets that the ZyXEL Device sends (it recognizes both formats when receiving). **RIP-1** is universally supported; but RIP-2 carries more information. RIP-1 is probably adequate for most networks, unless you have an unusual network topology.

Both **RIP-2B** and **RIP-2M** sends the routing data in RIP-2 format; the difference being that **RIP-2B** uses subnet broadcasting while **RIP-2M** uses multicasting.

5.2.3 Multicast

Traditionally, IP packets are transmitted in one of either two ways - Unicast (1 sender - 1 recipient) or Broadcast (1 sender - everybody on the network). Multicast delivers IP packets to a group of hosts on the network - not everybody and not just 1.

IGMP (Internet Group Multicast Protocol) is a network-layer protocol used to establish membership in a Multicast group - it is not used to carry user data. IGMP version 2 (RFC 2236) is an improvement over version 1 (RFC 1112) but IGMP version 1 is still in wide use. If you would like to read more detailed information about interoperability between IGMP version 2 and version 1, please see sections 4 and 5 of RFC 2236. The class D IP address is used to identify host groups and can be in the range 224.0.0.0 to 239.255.255.255. The address 224.0.0.0 is not assigned to any group and is used by IP multicast computers. The address 224.0.0.1 is used for query messages and is assigned to the permanent group of all IP hosts (including gateways). All hosts must join the 224.0.0.1 group in order to participate in IGMP. The address 224.0.0.2 is assigned to the multicast routers group.

The ZyXEL Device supports both IGMP version 1 (**IGMP-v1**) and IGMP version 2 (**IGMP-v2**). At start up, the ZyXEL Device queries all directly connected networks to gather group membership. After that, the ZyXEL Device periodically updates this information. IP multicasting can be enabled/disabled on the ZyXEL Device LAN and/or WAN interfaces in the web configurator (**LAN**; **WAN**). Select **None** to disable IP multicasting on these interfaces.

5.2.4 Any IP

Traditionally, you must set the IP addresses and the subnet masks of a computer and the ZyXEL Device to be in the same subnet to allow the computer to access the Internet (through the ZyXEL Device). In cases where your computer is required to use a static IP address in another network, you may need to manually configure the network settings of the computer every time you want to access the Internet via the ZyXEL Device.

With the Any IP feature and NAT enabled, the ZyXEL Device allows a computer to access the Internet without changing the network settings (such as IP address and subnet mask) of the computer, when the IP addresses of the computer and the ZyXEL Device are not in the same subnet. Whether a computer is set to use a dynamic or static (fixed) IP address, you can simply connect the computer to the ZyXEL Device and access the Internet.

The following figure depicts a scenario where a computer is set to use a static private IP address in the corporate environment. In a residential house where a ZyXEL Device is installed, you can still use the computer to access the Internet without changing the network settings, even when the IP addresses of the computer and the ZyXEL Device are not in the same subnet.

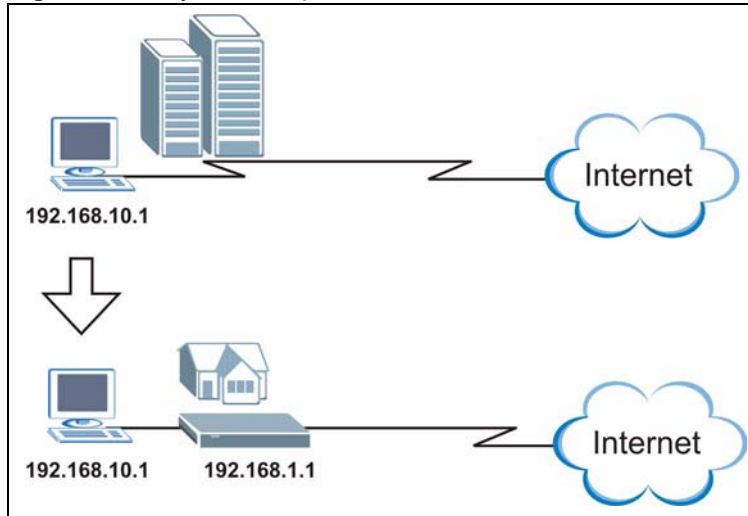
Figure 35 Any IP Example

The Any IP feature does not apply to a computer using either a dynamic IP address or a static IP address that is in the same subnet as the ZyXEL Device's IP address.

Note: You *must* enable NAT/SUA to use the Any IP feature on the ZyXEL Device.

5.2.4.1 How Any IP Works

Address Resolution Protocol (ARP) is a protocol for mapping an Internet Protocol address (IP address) to a physical machine address, also known as a Media Access Control or MAC address, on the local area network. IP routing table is defined on IP Ethernet devices (the ZyXEL Device) to decide which hop to use, to help forward data along to its specified destination.

The following lists out the steps taken, when a computer tries to access the Internet for the first time through the ZyXEL Device.

- 1** When a computer (which is in a different subnet) first attempts to access the Internet, it sends packets to its default gateway (which is not the ZyXEL Device) by looking at the MAC address in its ARP table.
- 2** When the computer cannot locate the default gateway, an ARP request is broadcast on the LAN.
- 3** The ZyXEL Device receives the ARP request and replies to the computer with its own MAC address.
- 4** The computer updates the MAC address for the default gateway to the ARP table. Once the ARP table is updated, the computer is able to access the Internet through the ZyXEL Device.
- 5** When the ZyXEL Device receives packets from the computer, it creates an entry in the IP routing table so it can properly forward packets intended for the computer.

After all the routing information is updated, the computer can access the ZyXEL Device and the Internet as if it is in the same subnet as the ZyXEL Device.

5.3 Configuring LAN IP

Click **LAN** to open the **IP** screen. See [Section 5.1 on page 66](#) for background information.

Figure 36 LAN IP

The following table describes the fields in this screen.

Table 18 LAN IP

LABEL	DESCRIPTION
TCP/IP	
IP Address	Enter the IP address of your ZyXEL Device in dotted decimal notation, for example, 192.168.1.1 (factory default).
IP Subnet Mask	Type the subnet mask assigned to you by your ISP (if given).
Apply	Click Apply to save your changes back to the ZyXEL Device.
Cancel	Click Cancel to begin configuring this screen afresh.
Advanced Setup	Click this button to display the Advanced LAN Setup screen and edit more details of your LAN setup.

5.3.1 Configuring Advanced LAN Setup

To edit your ZyXEL Device's advanced LAN settings, click the **Advanced Setup** button in the **LAN IP** screen. The screen appears as shown.

Figure 37 Advanced LAN Setup

The following table describes the labels in this screen.

Table 19 Advanced LAN Setup

LABEL	DESCRIPTION
RIP & Multicast Setup	
RIP Direction	Select the RIP direction from None , Both , In Only and Out Only .
RIP Version	Select the RIP version from RIP-1 , RIP-2B and RIP-2M .
Multicast	IGMP (Internet Group Multicast Protocol) is a network-layer protocol used to establish membership in a multicast group. The ZyXEL Device supports both IGMP version 1 (IGMP-v1) and IGMP-v2 . Select None to disable it.
Any IP Setup	Select the Active check box to enable the Any IP feature. This allows a computer to access the Internet without changing the network settings (such as IP address and subnet mask) of the computer, even when the IP addresses of the computer and the ZyXEL Device are not in the same subnet. When you disable the Any IP feature, only computers with dynamic IP addresses or static IP addresses in the same subnet as the ZyXEL Device's LAN IP address can connect to the ZyXEL Device or access the Internet through the ZyXEL Device.
Windows Networking (NetBIOS over TCP/IP)	NetBIOS (Network Basic Input/Output System) are TCP or UDP packets that enable a computer to connect to and communicate with a LAN. For some dial-up services such as PPPoE or PPTP, NetBIOS packets cause unwanted calls. However it may sometimes be necessary to allow NetBIOS packets to pass through to the WAN in order to find a computer on the WAN.
Allow between LAN and WAN	Select this check box to forward NetBIOS packets from the LAN to the WAN and from the WAN to the LAN. If your firewall is enabled with the default policy set to block WAN to LAN traffic, you also need to enable the default WAN to LAN firewall rule that forwards NetBIOS traffic. Clear this check box to block all NetBIOS packets going from the LAN to the WAN and from the WAN to the LAN.
Back	Click Back to return to the previous screen.
Apply	Click Apply to save the changes.
Cancel	Click Cancel to begin configuring this screen afresh.

5.4 DHCP Setup

Use this screen to configure the DNS server information that the ZyXEL Device sends to the DHCP client devices on the LAN.

Figure 38 DHCP Setup

The following table describes the labels in this screen.

Table 20 DHCP Setup

LABEL	DESCRIPTION
DHCP Setup	
DHCP	<p>If set to Server, your ZyXEL Device can assign IP addresses, an IP default gateway and DNS servers to Windows 95, Windows NT and other systems that support the DHCP client.</p> <p>If set to None, the DHCP server will be disabled.</p> <p>If set to Relay, the ZyXEL Device acts as a surrogate DHCP server and relays DHCP requests and responses between the remote server and the clients. Enter the IP address of the actual, remote DHCP server in the Remote DHCP Server field in this case.</p> <p>When DHCP is used, the following items need to be set:</p>
IP Pool Starting Address	This field specifies the first of the contiguous addresses in the IP address pool.
Pool Size	This field specifies the size, or count of the IP address pool.
Remote DHCP Server	If Relay is selected in the DHCP field above then enter the IP address of the actual remote DHCP server here.
DNS Server	
DNS Servers Assigned by DHCP Server	The ZyXEL Device passes a DNS (Domain Name System) server IP address to the DHCP clients.

Table 20 DHCP Setup

LABEL	DESCRIPTION
Primary DNS Server	This field is not available when you set DHCP to Relay .
Secondary DNS Server	Enter the IP addresses of the DNS servers. The DNS servers are passed to the DHCP clients along with the IP address and the subnet mask. If the fields are left as 0.0.0.0 , the ZyXEL Device acts as a DNS proxy and forwards the DHCP client's DNS query to the real DNS server learned through IPCP and relays the response back to the computer.
Apply	Click Apply to save your changes back to the ZyXEL Device.
Reset	Click Reset to begin configuring this screen afresh.

5.5 LAN Client List

This table allows you to assign IP addresses on the LAN to specific individual computers based on their MAC Addresses.

Every Ethernet device has a unique MAC (Media Access Control) address. The MAC address is assigned at the factory and consists of six pairs of hexadecimal characters, for example, 00:A0:C5:00:00:02.

To change your ZyXEL Device's static DHCP settings, click **Network > LAN > Client List**. The screen appears as shown.

Figure 39 LAN Client List

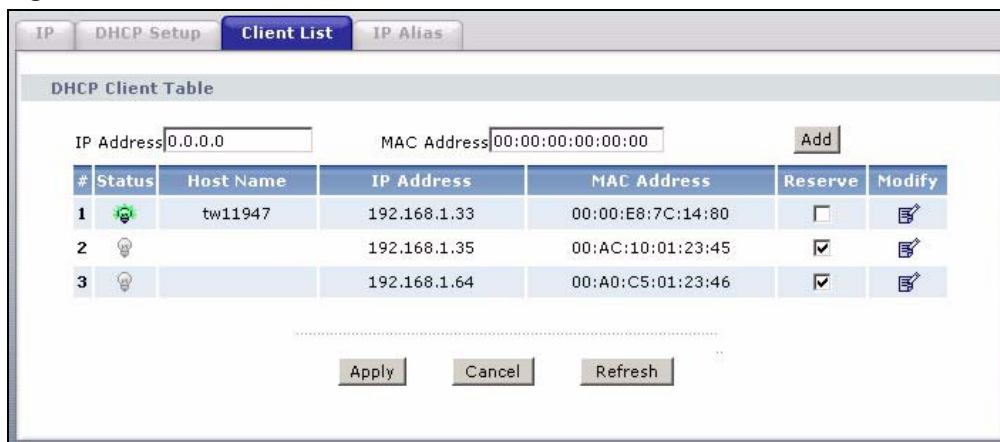

The following table describes the labels in this screen.

Table 21 LAN Client List

LABEL	DESCRIPTION
IP Address	Enter the IP address that you want to assign to the computer on your LAN with the MAC address specified below. The IP address should be within the range of IP addresses you specified in the DHCP Setup for the DHCP client.
MAC Address	Enter the MAC address of a computer on your LAN.
Add	Click Add to add a static DHCP entry.
#	This is the index number of the static IP table entry (row).
Status	This field displays whether the client is connected to the ZyXEL Device.
Host Name	This field displays the computer host name.
IP Address	This field displays the IP address relative to the # field listed above.
MAC Address	The MAC (Media Access Control) or Ethernet address on a LAN (Local Area Network) is unique to your computer (six pairs of hexadecimal notation). A network interface card such as an Ethernet adapter has a hardwired address that is assigned at the factory. This address follows an industry standard that ensures no other adapter has a similar address.
Reserve	Select the check box(es) in each entry to have the ZyXEL Device always assign the selected entry(ies)'s IP address(es) to the corresponding MAC address(es) (and host name(s)). You can select up to 32 entries in this table.
Modify	Click the modify icon to have the IP address field editable and change it.
Apply	Click Apply to save your changes back to the ZyXEL Device.
Cancel	Click Cancel to begin configuring this screen afresh.
Refresh	Click Refresh to reload the DHCP table.

5.6 LAN IP Alias

IP alias allows you to partition a physical network into different logical networks over the same Ethernet interface. The ZyXEL Device supports three logical LAN interfaces via its single physical Ethernet interface with the ZyXEL Device itself as the gateway for each LAN network.

Note: Make sure that the subnets of the logical networks do not overlap.

The following figure shows a LAN divided into subnets A, B, and C.

Figure 40 Physical Network & Partitioned Logical Networks

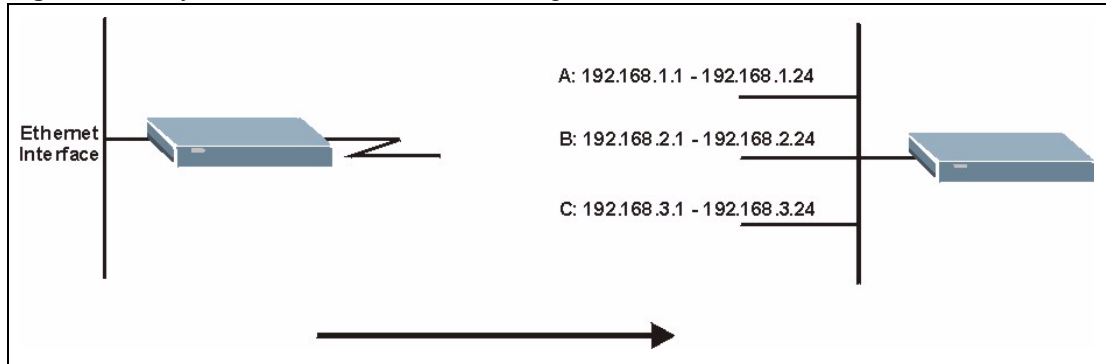

To change your ZyXEL Device's IP alias settings, click **Network > LAN > IP Alias**. The screen appears as shown.

Figure 41 LAN IP Alias

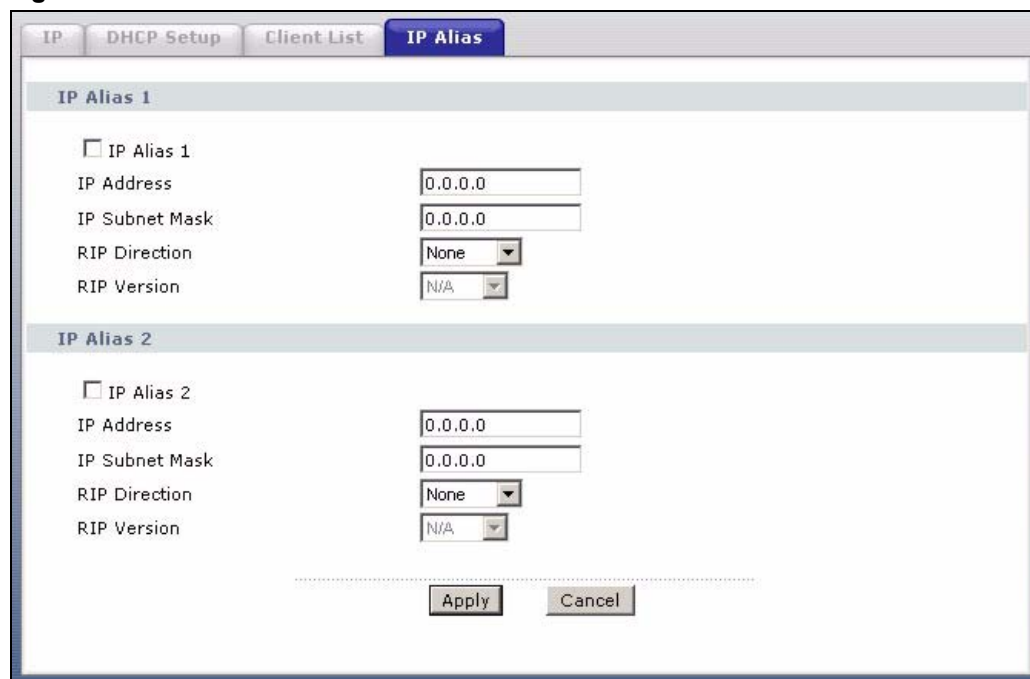

The following table describes the labels in this screen.

Table 22 LAN IP Alias

LABEL	DESCRIPTION
IP Alias 1, 2	Select the check box to configure another LAN network for the ZyXEL Device.
IP Address	Enter the IP address of your ZyXEL Device in dotted decimal notation. Alternatively, click the right mouse button to copy and/or paste the IP address.
IP Subnet Mask	Your ZyXEL Device will automatically calculate the subnet mask based on the IP address that you assign. Unless you are implementing subnetting, use the subnet mask computed by the ZyXEL Device.

Table 22 LAN IP Alias

LABEL	DESCRIPTION
RIP Direction	RIP (Routing Information Protocol, RFC 1058 and RFC 1389) allows a router to exchange routing information with other routers. The RIP Direction field controls the sending and receiving of RIP packets. Select the RIP direction from Both/In Only/Out Only/None . When set to Both or Out Only , the ZyXEL Device will broadcast its routing table periodically. When set to Both or In Only , it will incorporate the RIP information that it receives; when set to None , it will not send any RIP packets and will ignore any RIP packets received.
RIP Version	The RIP Version field controls the format and the broadcasting method of the RIP packets that the ZyXEL Device sends (it recognizes both formats when receiving). RIP-1 is universally supported but RIP-2 carries more information. RIP-1 is probably adequate for most networks, unless you have an unusual network topology. Both RIP-2B and RIP-2M sends the routing data in RIP-2 format; the difference being that RIP-2B uses subnet broadcasting while RIP-2M uses multicasting. Multicasting can reduce the load on non-router machines since they generally do not listen to the RIP multicast address and so will not receive the RIP packets. However, if one router uses multicasting, then all routers on your network must use multicasting, also. By default, RIP direction is set to Both and the Version set to RIP-1 .
Apply	Click Apply to save your changes back to the ZyXEL Device.
Cancel	Click Cancel to begin configuring this screen afresh.

CHAPTER 6

Network Address Translation (NAT) Screens

This chapter discusses how to configure NAT on the ZyXEL Device.

6.1 NAT Overview

NAT (Network Address Translation - NAT, RFC 1631) is the translation of the IP address of a host in a packet, for example, the source address of an outgoing packet, used within one network to a different IP address known within another network.

6.1.1 NAT Definitions

Inside/outside denotes where a host is located relative to the ZyXEL Device, for example, the computers of your subscribers are the inside hosts, while the web servers on the Internet are the outside hosts.

Global/local denotes the IP address of a host in a packet as the packet traverses a router, for example, the local address refers to the IP address of a host when the packet is in the local network, while the global address refers to the IP address of the host when the same packet is traveling in the WAN side.

Note that inside/outside refers to the location of a host, while global/local refers to the IP address of a host used in a packet. Thus, an inside local address (ILA) is the IP address of an inside host in a packet when the packet is still in the local network, while an inside global address (IGA) is the IP address of the same inside host when the packet is on the WAN side. The following table summarizes this information.

Table 23 NAT Definitions

ITEM	DESCRIPTION
Inside	This refers to the host on the LAN.
Outside	This refers to the host on the WAN.
Local	This refers to the packet address (source or destination) as the packet travels on the LAN.
Global	This refers to the packet address (source or destination) as the packet travels on the WAN.

NAT never changes the IP address (either local or global) of an outside host.

6.1.2 What NAT Does

In the simplest form, NAT changes the source IP address in a packet received from a subscriber (the inside local address) to another (the inside global address) before forwarding the packet to the WAN side. When the response comes back, NAT translates the destination address (the inside global address) back to the inside local address before forwarding it to the original inside host. Note that the IP address (either local or global) of an outside host is never changed.

The global IP addresses for the inside hosts can be either static or dynamically assigned by the ISP. In addition, you can designate servers, for example, a web server and a telnet server, on your local network and make them accessible to the outside world. If you do not define any servers (for Many-to-One and Many-to-Many Overload mapping – see [Table 24 on page 83](#)), NAT offers the additional benefit of firewall protection. With no servers defined, your ZyXEL Device filters out all incoming inquiries, thus preventing intruders from probing your network. For more information on IP address translation, refer to *RFC 1631, The IP Network Address Translator (NAT)*.

6.1.3 How NAT Works

Each packet has two addresses – a source address and a destination address. For outgoing packets, the ILA (Inside Local Address) is the source address on the LAN, and the IGA (Inside Global Address) is the source address on the WAN. For incoming packets, the ILA is the destination address on the LAN, and the IGA is the destination address on the WAN. NAT maps private (local) IP addresses to globally unique ones required for communication with hosts on other networks. It replaces the original IP source address (and TCP or UDP source port numbers for Many-to-One and Many-to-Many Overload NAT mapping) in each packet and then forwards it to the Internet. The ZyXEL Device keeps track of the original addresses and port numbers so incoming reply packets can have their original values restored. The following figure illustrates this.

Figure 42 How NAT Works

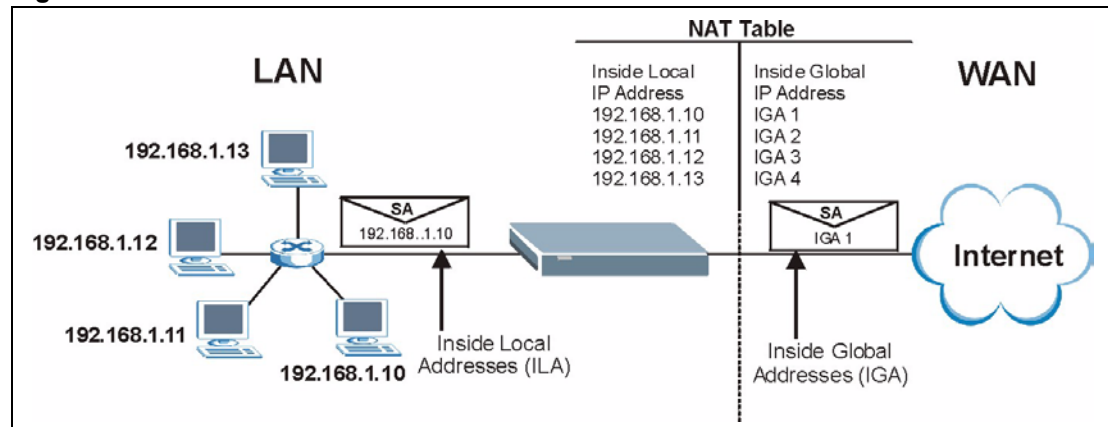

6.1.4 NAT Application

The following figure illustrates a possible NAT application, where three inside LANs (logical LANs using IP Aliases) behind the ZyXEL Device can communicate with three distinct WAN networks. More examples follow at the end of this chapter.

Figure 43 NAT Application With IP Alias

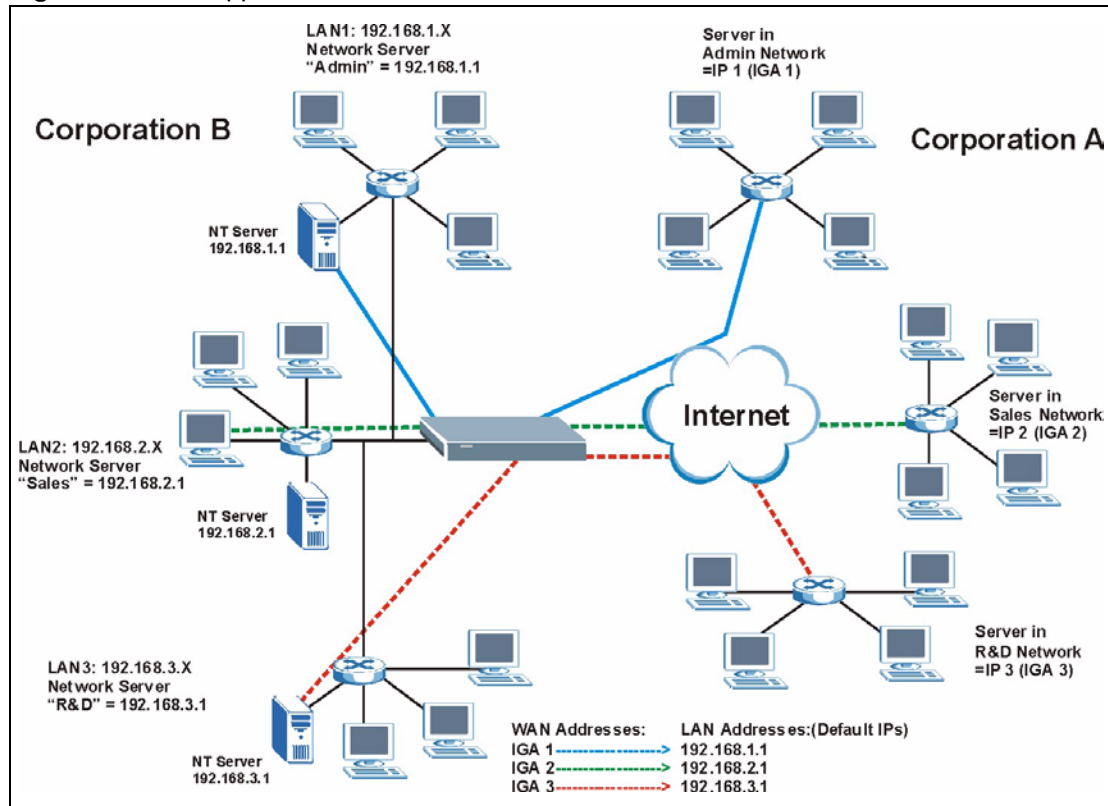

6.1.5 NAT Mapping Types

NAT supports five types of IP/port mapping. They are:

- **One to One:** In One-to-One mode, the ZyXEL Device maps one local IP address to one global IP address.
- **Many to One:** In Many-to-One mode, the ZyXEL Device maps multiple local IP addresses to one global IP address. This is equivalent to SUA (for instance, PAT, port address translation), ZyXEL's Single User Account feature that previous ZyXEL routers supported (the **SUA Only** option in today's routers).
- **Many to Many Overload:** In Many-to-Many Overload mode, the ZyXEL Device maps the multiple local IP addresses to shared global IP addresses.
- **Many-to-Many No Overload:** In Many-to-Many No Overload mode, the ZyXEL Device maps each local IP address to a unique global IP address.
- **Server:** This type allows you to specify inside servers of different services behind the NAT to be accessible to the outside world.

Port numbers do NOT change for **One-to-One** and **Many-to-Many No Overload** NAT mapping types.

The following table summarizes these types.

Table 24 NAT Mapping Types

TYPE	IP MAPPING
One-to-One	ILA1 ↔ IGA1
Many-to-One (SUA/PAT)	ILA1 ↔ IGA1 ILA2 ↔ IGA1 ...
Many-to-Many Overload	ILA1 ↔ IGA1 ILA2 ↔ IGA2 ILA3 ↔ IGA1 ILA4 ↔ IGA2 ...
Many-to-Many No Overload	ILA1 ↔ IGA1 ILA2 ↔ IGA2 ILA3 ↔ IGA3 ...
Server	Server 1 IP ↔ IGA1 Server 2 IP ↔ IGA1 Server 3 IP ↔ IGA1

6.2 SUA (Single User Account) Versus NAT

SUA (Single User Account) is a ZyNOS implementation of a subset of NAT that supports two types of mapping, **Many-to-One** and **Server**. The ZyXEL Device also supports **Full Feature** NAT to map multiple global IP addresses to multiple private LAN IP addresses of clients or servers using mapping types as outlined in [Table 24 on page 83](#).

- Choose **SUA Only** if you have just one public WAN IP address for your ZyXEL Device.
- Choose **Full Feature** if you have multiple public WAN IP addresses for your ZyXEL Device.

6.3 NAT General Setup

You must create a firewall rule in addition to setting up SUA/NAT, to allow traffic from the WAN to be forwarded through the ZyXEL Device. Click **Network > NAT** to open the following screen. Not all fields are available on all models.

Figure 44 NAT General

The following table describes the labels in this screen.

Table 25 NAT General

LABEL	DESCRIPTION
Active Network Address Translation (NAT)	Select this check box to enable NAT.
SUA Only	Select this radio button if you have just one public WAN IP address for your ZyXEL Device.
Full Feature	Select this radio button if you have multiple public WAN IP addresses for your ZyXEL Device.
Max NAT/ Firewall Session Per User	<p>When computers use peer to peer applications, such as file sharing applications, they may use a large number of NAT sessions. If you do not limit the number of NAT sessions a single client can establish, this can result in all of the available NAT sessions being used. In this case, no additional NAT sessions can be established, and users may not be able to access the Internet.</p> <p>Each NAT session establishes a corresponding firewall session. Use this field to limit the number of NAT/firewall sessions each client computer can establish through the ZyXEL Device.</p> <p>If your network has a small number of clients using peer to peer applications, you can raise this number to ensure that their performance is not degraded by the number of NAT sessions they can establish. If your network has a large number of users using peer to peer applications, you can lower this number to ensure no single client is using all of the available NAT sessions.</p>
Apply	Click Apply to save your changes back to the ZyXEL Device.
Cancel	Click Cancel to reload the previous configuration for this screen.

6.4 Port Forwarding

A port forwarding set is a list of inside (behind NAT on the LAN) servers, for example, web or FTP, that you can make visible to the outside world even though NAT makes your whole inside network appear as a single computer to the outside world.

You may enter a single port number or a range of port numbers to be forwarded, and the local IP address of the desired server. The port number identifies a service; for example, web service is on port 80 and FTP on port 21. In some cases, such as for unknown services or where one server can support more than one service (for example both FTP and web service), it might be better to specify a range of port numbers. You can allocate a server IP address that corresponds to a port or a range of ports.

Many residential broadband ISP accounts do not allow you to run any server processes (such as a Web or FTP server) from your location. Your ISP may periodically check for servers and may suspend your account if it discovers any active services at your location. If you are unsure, refer to your ISP.

6.4.1 Default Server IP Address

In addition to the servers for specified services, NAT supports a default server IP address. A default server receives packets from ports that are not specified in this screen.

Note: If you do not assign a **Default Server** IP address, the ZyXEL Device discards all packets received for ports that are not specified here or in the remote management setup.

6.4.2 Port Forwarding: Services and Port Numbers

Use the **Port Forwarding** screen to forward incoming service requests to the server(s) on your local network.

The most often used port numbers are shown in the following table. Please refer to RFC 1700 for further information about port numbers.

Table 26 Services and Port Numbers

SERVICES	PORT NUMBER
ECHO	7
FTP (File Transfer Protocol)	21
SMTP (Simple Mail Transfer Protocol)	25
DNS (Domain Name System)	53
Finger	79
HTTP (Hyper Text Transfer protocol or WWW, Web)	80
POP3 (Post Office Protocol)	110
NNTP (Network News Transport Protocol)	119
SNMP (Simple Network Management Protocol)	161
SNMP trap	162
PPTP (Point-to-Point Tunneling Protocol)	1723

6.4.3 Configuring Servers Behind Port Forwarding (Example)

Let's say you want to assign ports 21-25 to one FTP, Telnet and SMTP server (**A** in the example), port 80 to another (**B** in the example) and assign a default server IP address of 192.168.1.35 to a third (**C** in the example). You assign the LAN IP addresses and the ISP assigns the WAN IP address. The NAT network appears as a single host on the Internet.

Figure 45 Multiple Servers Behind NAT Example

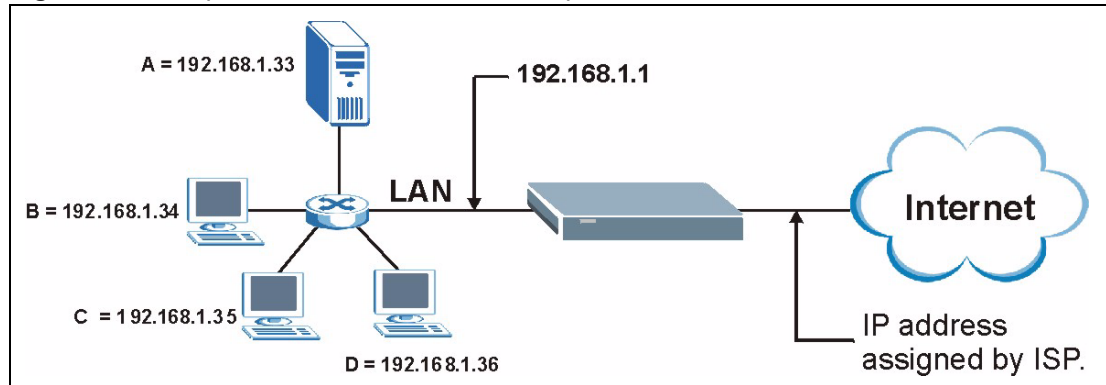

6.5 Configuring Port Forwarding

Note: The **Port Forwarding** screen is available only when you select **SUA Only** in the **NAT > General** screen.

If you do not assign a **Default Server IP** address, the ZyXEL Device discards all packets received for ports that are not specified here or in the remote management setup.

Click **Network > NAT > Port Forwarding** to open the following screen.

See [Table 26 on page 85](#) for port numbers commonly used for particular services.

Figure 46 NAT Port Forwarding

#	Active	Service Name	Start Port	End Port	Server IP Address	Modify
1	<input checked="" type="checkbox"/>	WWW	80	80	172.23.15.23	

The following table describes the fields in this screen.

Table 27 NAT Port Forwarding

LABEL	DESCRIPTION
Default Server Setup	
Default Server	In addition to the servers for specified services, NAT supports a default server. A default server receives packets from ports that are not specified in this screen. If you do not assign a Default Server IP address, the ZyXEL Device discards all packets received for ports that are not specified here or in the remote management setup.
Port Forwarding	
Service Name	Select a service from the drop-down list box.
Server IP Address	Enter the IP address of the server for the specified service.
Add	Click this button to add a rule to the table below.
#	This is the rule index number (read-only).
Active	Click this check box to enable the rule.
Service Name	This is a service's name.
Start Port	This is the first port number that identifies a service.
End Port	This is the last port number that identifies a service.
Server IP Address	This is the server's IP address.
Modify	Click the edit icon to go to the screen where you can edit the port forwarding rule. Click the delete icon to delete an existing port forwarding rule. Note that subsequent rules move up by one when you take this action.
Apply	Click Apply to save your changes back to the ZyXEL Device.
Cancel	Click Cancel to return to the previous configuration.

6.5.1 Port Forwarding Rule Edit

To edit a port forwarding rule, click the rule's edit icon in the **Port Forwarding** screen to display the screen shown next.

Figure 47 Port Forwarding Rule Setup

The screenshot shows a configuration window titled "Rule Setup". It contains the following fields and controls:

- Active
- Service Name:
- Start Port:
- End Port:
- Server IP Address:

At the bottom of the window, there are three buttons: **Back**, **Apply**, and **Cancel**.

The following table describes the fields in this screen.

Table 28 Port Forwarding Rule Setup

LABEL	DESCRIPTION
Active	Click this check box to enable the rule.
Service Name	Enter a name to identify this port-forwarding rule.
Start Port	Enter a port number in this field. To forward only one port, enter the port number again in the End Port field. To forward a series of ports, enter the start port number here and the end port number in the End Port field.
End Port	Enter a port number in this field. To forward only one port, enter the port number again in the Start Port field above and then enter it again in this field. To forward a series of ports, enter the last port number in a series that begins with the port number in the Start Port field above.
Server IP Address	Enter the inside IP address of the server here.
Back	Click Back to return to the previous screen.
Apply	Click Apply to save your changes back to the ZyXEL Device.
Cancel	Click Cancel to begin configuring this screen afresh.

6.6 Address Mapping

Note: The **Address Mapping** screen is available only when you select **Full Feature** in the **NAT > General** screen.

Ordering your rules is important because the ZyXEL Device applies the rules in the order that you specify. When a rule matches the current packet, the ZyXEL Device takes the corresponding action and the remaining rules are ignored. If there are any empty rules before your new configured rule, your configured rule will be pushed up by that number of empty rules. For example, if you have already configured rules 1 to 6 in your current set and now you configure rule number 9. In the set summary screen, the new rule will be rule 7, not 9. Now if you delete rule 4, rules 5 to 7 will be pushed up by 1 rule, so old rules 5, 6 and 7 become new rules 4, 5 and 6.

To change your ZyXEL Device's address mapping settings, click **Network > NAT > Address Mapping** to open the following screen.

Figure 48 Address Mapping Rules

The following table describes the fields in this screen.

Table 29 Address Mapping Rules

LABEL	DESCRIPTION
#	This is the rule index number.
Local Start IP	This is the starting Inside Local IP Address (ILA). Local IP addresses are N/A for Server port mapping.
Local End IP	This is the end Inside Local IP Address (ILA). If the rule is for all local IP addresses, then this field displays 0.0.0.0 as the Local Start IP address and 255.255.255.255 as the Local End IP address. This field is N/A for One-to-one and Server mapping types.
Global Start IP	This is the starting Inside Global IP Address (IGA). Enter 0.0.0.0 here if you have a dynamic IP address from your ISP. You can only do this for Many-to-One and Server mapping types.
Global End IP	This is the ending Inside Global IP Address (IGA). This field is N/A for One-to-one , Many-to-One and Server mapping types.
Type	<p>1-1: One-to-one mode maps one local IP address to one global IP address. Note that port numbers do not change for the One-to-one NAT mapping type.</p> <p>M-1: Many-to-One mode maps multiple local IP addresses to one global IP address. This is equivalent to SUA (i.e., PAT, port address translation), ZyXEL's Single User Account feature that previous ZyXEL routers supported only.</p> <p>M-M Ov (Overload): Many-to-Many Overload mode maps multiple local IP addresses to shared global IP addresses.</p> <p>MM No (No Overload): Many-to-Many No Overload mode maps each local IP address to unique global IP addresses.</p> <p>Server: This type allows you to specify inside servers of different services behind the NAT to be accessible to the outside world.</p>
Modify	Click the edit icon to go to the screen where you can edit the address mapping rule. Click the delete icon to delete an existing address mapping rule. Note that subsequent address mapping rules move up by one when you take this action.

6.6.1 Address Mapping Rule Edit

To edit an address mapping rule, click the rule's edit icon in the **Address Mapping** screen to display the screen shown next.

Figure 49 Edit Address Mapping Rule

The screenshot shows a web-based configuration interface titled "Edit Address Mapping Rule 1". It contains several input fields and a dropdown menu. The "Type" field is a dropdown menu currently set to "One-to-One". The "Local Start IP" field contains "0.0.0.0", and the "Local End IP" field contains "N/A". The "Global Start IP" field contains "0.0.0.0", and the "Global End IP" field contains "N/A". The "Server Mapping Set" field is a dropdown menu currently set to "N/A", with a blue link "Edit Details" next to it. At the bottom of the form, there are three buttons: "Back", "Apply", and "Cancel".

The following table describes the fields in this screen.

Table 30 Edit Address Mapping Rule

LABEL	DESCRIPTION
Type	Choose the port mapping type from one of the following. <ul style="list-style-type: none"> • One-to-One: One-to-One mode maps one local IP address to one global IP address. Note that port numbers do not change for One-to-one NAT mapping type. • Many-to-One: Many-to-One mode maps multiple local IP addresses to one global IP address. This is equivalent to SUA (i.e., PAT, port address translation), ZyXEL's Single User Account feature that previous ZyXEL routers supported only. • Many-to-Many Overload: Many-to-Many Overload mode maps multiple local IP addresses to shared global IP addresses. • Many-to-Many No Overload: Many-to-Many No Overload mode maps each local IP address to unique global IP addresses. • Server: This type allows you to specify inside servers of different services behind the NAT to be accessible to the outside world.
Local Start IP	This is the starting local IP address (ILA). Local IP addresses are N/A for Server port mapping.
Local End IP	This is the end local IP address (ILA). If your rule is for all local IP addresses, then enter 0.0.0.0 as the Local Start IP address and 255.255.255.255 as the Local End IP address. This field is N/A for One-to-One and Server mapping types.
Global Start IP	This is the starting global IP address (IGA). Enter 0.0.0.0 here if you have a dynamic IP address from your ISP.
Global End IP	This is the ending global IP address (IGA). This field is N/A for One-to-One , Many-to-One and Server mapping types.
Server Mapping Set	Only available when Type is set to Server . Select a number from the drop-down menu to choose a server mapping set.

Table 30 Edit Address Mapping Rule (continued)

LABEL	DESCRIPTION
Edit Details	Click this link to go to the Port Forwarding screen to edit a server mapping set that you have selected in the Server Mapping Set field.
Back	Click Back to return to the previous screen.
Apply	Click Apply to save your changes back to the ZyXEL Device.
Cancel	Click Cancel to begin configuring this screen afresh.

CHAPTER 7

Static Route

This chapter shows you how to configure static routes for your ZyXEL Device.

7.1 Static Route

Each remote node specifies only the network to which the gateway is directly connected, and the ZyXEL Device has no knowledge of the networks beyond. For instance, the ZyXEL Device knows about network N2 in the following figure through remote node Router 1. However, the ZyXEL Device is unable to route a packet to network N3 because it doesn't know that there is a route through the same remote node Router 1 (via gateway Router 2). The static routes are for you to tell the ZyXEL Device about the networks beyond the remote nodes.

Figure 50 Example of Static Routing Topology

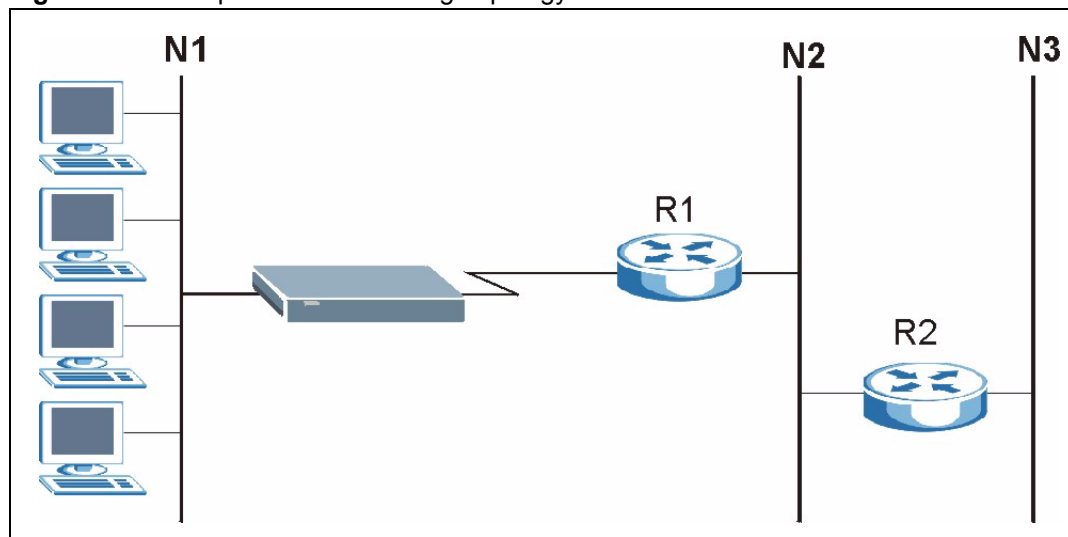

7.2 Configuring Static Route

Click **Advanced** > **Static Route** to open the **Static Route** screen.

Figure 51 Static Route



The following table describes the labels in this screen.

Table 31 Static Route

LABEL	DESCRIPTION
#	This is the number of an individual static route.
Active	Select the check box to activate this static route. Otherwise, clear the check box.
Name	This is the name that describes or identifies this route.
Destination	This parameter specifies the IP network address of the final destination. Routing is always based on network number.
Gateway	This is the IP address of the gateway. The gateway is a router or switch on the same network segment as the device's LAN or WAN port. The gateway helps forward packets to their destinations.
Subnet Mask	This is the IP subnet mask.
Modify	Click the Edit icon to go to the screen where you can set up a static route on the ZyXEL Device. Click the Delete icon to remove a static route from the ZyXEL Device. A window displays asking you to confirm that you want to delete the route.

7.2.1 Static Route Edit

Select a static route index number and click **Edit**. The screen shown next appears. Use this screen to configure the required information for a static route.

Figure 52 Static Route Edit

The following table describes the labels in this screen.

Table 32 Static Route Edit

LABEL	DESCRIPTION
Active	This field allows you to activate/deactivate this static route.
Route Name	Enter the name of the IP static route. Leave this field blank to delete this static route.
Destination IP Address	This parameter specifies the IP network address of the final destination. Routing is always based on network number. If you need to specify a route to a single host, use a subnet mask of 255.255.255.255 in the subnet mask field to force the network number to be identical to the host ID.
IP Subnet Mask	Enter the IP subnet mask here.
Gateway IP Address	Enter the IP address of the gateway. The gateway is a router or switch on the same network segment as the device's LAN or WAN port. The gateway helps forward packets to their destinations.
Back	Click Back to return to the previous screen without saving.
Apply	Click Apply to save your changes back to the ZyXEL Device.
Cancel	Click Cancel to begin configuring this screen afresh.

CHAPTER 8

Dynamic DNS Setup

This chapter discusses how to configure your ZyXEL Device to use Dynamic DNS.

8.1 Dynamic DNS Overview

Dynamic DNS allows you to update your current dynamic IP address with one or many dynamic DNS services so that anyone can contact you (in NetMeeting, CU-SeeMe, etc.). You can also access your FTP server or Web site on your own computer using a domain name (for instance myhost.dhs.org, where myhost is a name of your choice) that will never change instead of using an IP address that changes each time you reconnect. Your friends or relatives will always be able to call you even if they don't know your IP address.

First of all, you need to have registered a dynamic DNS account with www.dyndns.org. This is for people with a dynamic IP from their ISP or DHCP server that would still like to have a domain name. The Dynamic DNS service provider will give you a password or key.

8.1.1 DYNDNS Wildcard

Enabling the wildcard feature for your host causes *.yourhost.dyndns.org to be aliased to the same IP address as yourhost.dyndns.org. This feature is useful if you want to be able to use, for example, www.yourhost.dyndns.org and still reach your hostname.

If you have a private WAN IP address, then you cannot use Dynamic DNS.

See [Section 8.2 on page 96](#) for configuration instruction.

8.2 Configuring Dynamic DNS

To change your ZyXEL Device's DDNS, click **Advanced > Dynamic DNS**. The screen appears as shown.

See [Section 8.1 on page 96](#) for more information.

Figure 53 Dynamic DNS

The following table describes the fields in this screen.

Table 33 Dynamic DNS

LABEL	DESCRIPTION
Dynamic DNS Setup	
Active Dynamic DNS	Select this check box to use dynamic DNS.
Service Provider	This is the name of your Dynamic DNS service provider.
Dynamic DNS Type	Select the type of service that you are registered for from your Dynamic DNS service provider.
Host Name	Type the domain name assigned to your ZyXEL Device by your Dynamic DNS provider. You can specify up to two host names in the field separated by a comma (",").
User Name	Type your user name.
Password	Type the password assigned to you.
Enable Wildcard Option	Select the check box to enable DynDNS Wildcard.
Enable off line option	This option is available when Custom DNS is selected in the DDNS Type field. Check with your Dynamic DNS service provider to have traffic redirected to a URL (that you can specify) while you are off line.
IP Address Update Policy	
Use WAN IP Address	Select this option to update the IP address of the host name(s) to the WAN IP address.

Table 33 Dynamic DNS (continued)

LABEL	DESCRIPTION
Dynamic DNS server auto detect IP Address	Select this option only when there are one or more NAT routers between the ZyXEL Device and the DDNS server. This feature has the DDNS server automatically detect and use the IP address of the NAT router that has a public IP address. Note: The DDNS server may not be able to detect the proper IP address if there is an HTTP proxy server between the ZyXEL Device and the DDNS server.
Use specified IP Address	Type the IP address of the host name(s). Use this if you have a static IP address.
Apply	Click Apply to save your changes back to the ZyXEL Device.
Cancel	Click Cancel to begin configuring this screen afresh.

CHAPTER 9

Remote Management Configuration

This chapter provides information on configuring remote management.

9.1 Remote Management Overview

Remote management allows you to determine which services/protocols can access which ZyXEL Device interface (if any) from which computers.

You may manage your ZyXEL Device from a remote location via:

- Internet (WAN only)
- ALL (LAN and WAN)
- LAN only,
- Neither (Disable).

To disable remote management of a service, select **Disable** in the corresponding **Access Status** field.

You may only have one remote management session running at a time. The ZyXEL Device automatically disconnects a remote management session of lower priority when another remote management session of higher priority starts. The priorities for the different types of remote management sessions are as follows.

- 1 Telnet
- 2 HTTP

9.1.1 Remote Management Limitations

Remote management over LAN or WAN will not work when:

- You have disabled that service in one of the remote management screens.
- The IP address in the **Secured Client IP** field does not match the client IP address. If it does not match, the ZyXEL Device will disconnect the session immediately.
- There is already another remote management session with an equal or higher priority running. You may only have one remote management session running at one time.
- There is a firewall rule that blocks it.

9.1.2 Remote Management and NAT

When NAT is enabled:

- Use the ZyXEL Device's WAN IP address when configuring from the WAN.
- Use the ZyXEL Device's LAN IP address when configuring from the LAN.

9.1.3 System Timeout

There is a default system management idle timeout of five minutes (three hundred seconds). The ZyXEL Device automatically logs you out if the management session remains idle for longer than this timeout period. The management session does not time out when a statistics screen is polling.

9.2 WWW

To change your ZyXEL Device's World Wide Web settings, click **Advanced > Remote MGMT** to display the **WWW** screen.

Figure 54 Remote Management: WWW

The screenshot shows the 'WWW' configuration page. At the top, there are tabs for 'Telnet', 'FTP', 'SNMP', 'DNS', and 'ICMP', with 'WWW' being the active tab. Below the tabs, the 'www' section is visible. It includes a 'Port' field set to '80', an 'Access Status' dropdown menu set to 'WAN', and a 'Secured Client IP' section with radio buttons for 'All' (selected) and 'Selected', followed by an IP address field containing '0.0.0.0'. A yellow note icon is present with the text: 'Note : 1: For UPnP to function normally, the HTTP service must be available for LAN computers using UPnP.' At the bottom of the form, there are 'Apply' and 'Cancel' buttons.

The following table describes the labels in this screen.

Table 34 Remote Management: WWW

LABEL	DESCRIPTION
Port	You may change the server port number for a service if needed, however you must use the same port number in order to use that service for remote management.
Access Status	Select the interface(s) through which a computer may access the ZyXEL Device using this service.

Table 34 Remote Management: WWW

LABEL	DESCRIPTION
Secured Client IP	A secured client is a “trusted” computer that is allowed to communicate with the ZyXEL Device using this service. Select All to allow any computer to access the ZyXEL Device using this service. Choose Selected to just allow the computer with the IP address that you specify to access the ZyXEL Device using this service.
Apply	Click Apply to save your settings back to the ZyXEL Device.
Cancel	Click Cancel to begin configuring this screen afresh.

9.3 Telnet

You can configure your ZyXEL Device for remote Telnet access as shown next. The administrator uses Telnet from a computer on a remote network to access the ZyXEL Device.

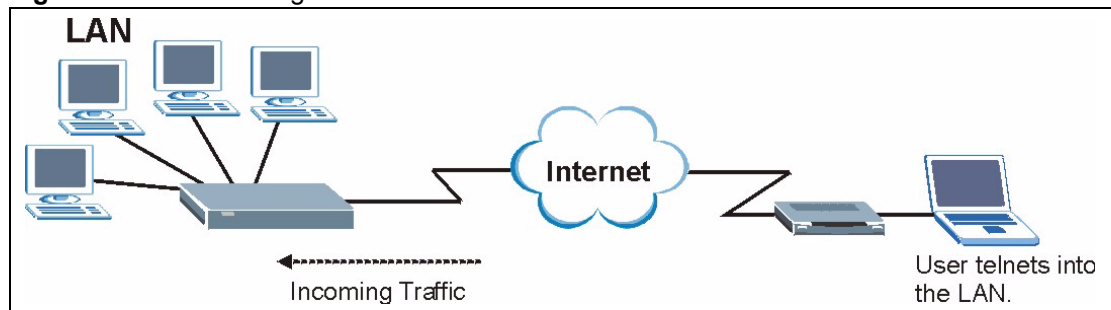
Figure 55 Telnet Configuration on a TCP/IP Network

9.4 Configuring Telnet

Click **Advanced > Remote MGMT > Telnet** tab to display the screen as shown.

Figure 56 Remote Management: Telnet

The following table describes the labels in this screen.

Table 35 Remote Management: Telnet

LABEL	DESCRIPTION
Port	You may change the server port number for a service if needed, however you must use the same port number in order to use that service for remote management.
Access Status	Select the interface(s) through which a computer may access the ZyXEL Device using this service.
Secured Client IP	A secured client is a "trusted" computer that is allowed to communicate with the ZyXEL Device using this service. Select All to allow any computer to access the ZyXEL Device using this service. Choose Selected to just allow the computer with the IP address that you specify to access the ZyXEL Device using this service.
Apply	Click Apply to save your customized settings and exit this screen.
Cancel	Click Cancel to begin configuring this screen afresh.

9.5 Configuring FTP

You can upload and download the ZyXEL Device's firmware and configuration files using FTP, please see the chapter on firmware and configuration file maintenance for details. To use this feature, your computer must have an FTP client.

To change your ZyXEL Device's FTP settings, click **Advanced > Remote MGMT > FTP** tab. The screen appears as shown.

Figure 57 Remote Management: FTP

The screenshot displays the 'Remote Management: FTP' configuration interface. At the top, there is a navigation bar with tabs for 'WWW', 'Telnet', 'FTP' (which is highlighted in blue), 'SNMP', 'DNS', and 'ICMP'. Below this, the 'FTP' configuration section is shown. It contains three main settings: 'Port' is a text input field containing '21'; 'Access Status' is a dropdown menu currently showing 'WAN'; and 'Secured Client IP' consists of two radio buttons, 'All' (which is selected) and 'Selected', followed by an IP address input field containing '0.0.0.0'. At the bottom of the configuration area, there are two buttons: 'Apply' and 'Cancel'.

The following table describes the labels in this screen.

Table 36 Remote Management: FTP

LABEL	DESCRIPTION
Port	You may change the server port number for a service if needed, however you must use the same port number in order to use that service for remote management.
Access Status	Select the interface(s) through which a computer may access the ZyXEL Device using this service.
Secured Client IP	A secured client is a "trusted" computer that is allowed to communicate with the ZyXEL Device using this service. Select All to allow any computer to access the ZyXEL Device using this service. Choose Selected to just allow the computer with the IP address that you specify to access the ZyXEL Device using this service.
Apply	Click Apply to save your customized settings and exit this screen.
Cancel	Click Cancel to begin configuring this screen afresh.

9.6 SNMP

Simple Network Management Protocol (SNMP) is a protocol used for exchanging management information between network devices. SNMP is a member of the TCP/IP protocol suite. Your ZyXEL Device supports SNMP agent functionality, which allows a manager station to manage and monitor the ZyXEL Device through the network. The ZyXEL Device supports SNMP version one (SNMPv1) and version two (SNMPv2). The next figure illustrates an SNMP management operation.

Note: SNMP is only available if TCP/IP is configured.

Figure 58 SNMP Management Model

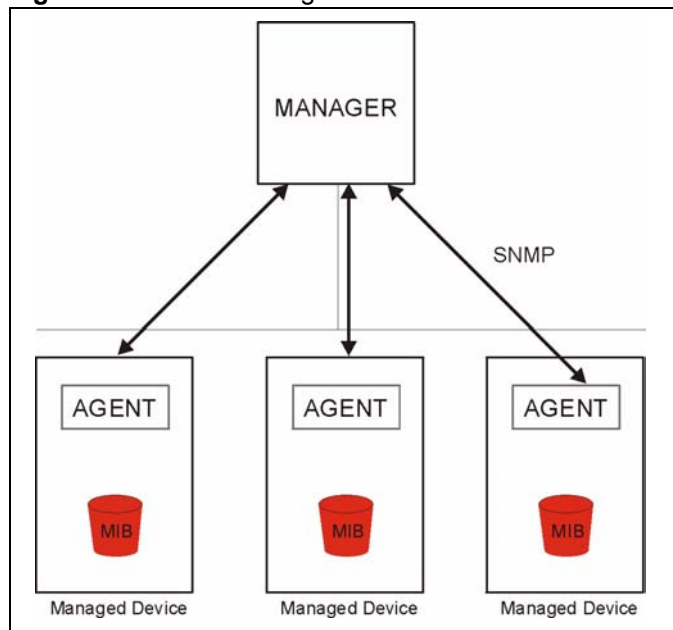

An SNMP managed network consists of two main types of component: agents and a manager.

An agent is a management software module that resides in a managed device (the ZyXEL Device). An agent translates the local management information from the managed device into a form compatible with SNMP. The manager is the console through which network administrators perform network management functions. It executes applications that control and monitor managed devices.

The managed devices contain object variables/managed objects that define each piece of information to be collected about a device. Examples of variables include such as number of packets received, node port status etc. A Management Information Base (MIB) is a collection of managed objects. SNMP allows a manager and agents to communicate for the purpose of accessing these objects.

SNMP itself is a simple request/response protocol based on the manager/agent model. The manager issues a request and the agent returns responses using the following protocol operations:

- Get - Allows the manager to retrieve an object variable from the agent.
- GetNext - Allows the manager to retrieve the next object variable from a table or list within an agent. In SNMPv1, when a manager wants to retrieve all elements of a table from an agent, it initiates a Get operation, followed by a series of GetNext operations.
- Set - Allows the manager to set values for object variables within an agent.
- Trap - Used by the agent to inform the manager of some events.

9.6.1 Supported MIBs

The ZyXEL Device supports MIB II that is defined in RFC-1213 and RFC-1215. The focus of the MIBs is to let administrators collect statistical data and monitor status and performance.

9.6.2 SNMP Traps

The ZyXEL Device will send traps to the SNMP manager when any one of the following events occurs:

Table 37 SNMP Traps

TRAP #	TRAP NAME	DESCRIPTION
0	coldStart (defined in <i>RFC-1215</i>)	A trap is sent after booting (power on).
1	warmStart (defined in <i>RFC-1215</i>)	A trap is sent after booting (software reboot).
6	whyReboot (defined in ZYXEL-MIB)	A trap is sent with the reason of restart before rebooting when the system is going to restart (warm start).
6a	For intentional reboot:	A trap is sent with the message "System reboot by user!" if reboot is done intentionally, (for example, download new files, CLI command "sys reboot", etc.).
6b	For fatal error:	A trap is sent with the message of the fatal code if the system reboots because of fatal errors.

9.6.3 Configuring SNMP

To change your ZyXEL Device's SNMP settings, click **Advanced > Remote MGMT > SNMP**. The screen appears as shown.

Figure 59 Remote Management: SNMP

The following table describes the labels in this screen.

Table 38 Remote Management: SNMP

LABEL	DESCRIPTION
SNMP	
Port	You may change the server port number for a service if needed, however you must use the same port number in order to use that service for remote management.
Access Status	Select the interface(s) through which a computer may access the ZyXEL Device using this service.
Secured Client IP	A secured client is a "trusted" computer that is allowed to communicate with the ZyXEL Device using this service. Select All to allow any computer to access the ZyXEL Device using this service. Choose Selected to just allow the computer with the IP address that you specify to access the ZyXEL Device using this service.
SNMP Configuration	
Get Community	Enter the Get Community , which is the password for the incoming Get and GetNext requests from the management station. The default is public and allows all requests.
Set Community	Enter the Set community , which is the password for incoming Set requests from the management station. The default is public and allows all requests.
Trap	

Table 38 Remote Management: SNMP

LABEL	DESCRIPTION
Community	Type the trap community, which is the password sent with each trap to the SNMP manager. The default is public and allows all requests.
Destination	Type the IP address of the station to send your SNMP traps to.
Apply	Click Apply to save your customized settings and exit this screen.
Cancel	Click Cancel to begin configuring this screen afresh.

9.7 Configuring DNS

Use DNS (Domain Name System) to map a domain name to its corresponding IP address and vice versa. Refer to the chapter on LAN for background information.

To change your ZyXEL Device's DNS settings, click **Advanced > Remote MGMT > DNS**. The screen appears as shown. Use this screen to set from which IP address the ZyXEL Device will accept DNS queries and on which interface it can send them your ZyXEL Device's DNS settings.

Figure 60 Remote Management: DNS

The screenshot shows the 'DNS' configuration page in a web interface. At the top, there are navigation tabs: WWW, Telnet, FTP, SNMP, DNS (highlighted in blue), and ICMP. Below the tabs, the 'DNS' section contains the following fields and controls:

- Port:** A text input field containing the value '53'.
- Access Status:** A dropdown menu currently set to 'LAN'.
- Secured Client IP:** Radio buttons for 'All' (which is selected) and 'Selected', followed by a text input field containing '0.0.0.0'.

At the bottom of the configuration area, there are two buttons: 'Apply' and 'Cancel'.

The following table describes the labels in this screen.

Table 39 Remote Management: DNS

LABEL	DESCRIPTION
Port	The DNS service port number is 53.
Access Status	Select the interface(s) through which a computer may send DNS queries to the ZyXEL Device.
Secured Client IP	A secured client is a "trusted" computer that is allowed to send DNS queries to the ZyXEL Device. Select All to allow any computer to send DNS queries to the ZyXEL Device. Choose Selected to just allow the computer with the IP address that you specify to send DNS queries to the ZyXEL Device.

Table 39 Remote Management: DNS

LABEL	DESCRIPTION
Apply	Click Apply to save your customized settings and exit this screen.
Cancel	Click Cancel to begin configuring this screen afresh.

9.8 Configuring ICMP

To change your ZyXEL Device's security settings, click **Advanced > Remote MGMT > ICMP**. The screen appears as shown.

If an outside user attempts to probe an unsupported port on your ZyXEL Device, an ICMP response packet is automatically returned. This allows the outside user to know the ZyXEL Device exists. Your ZyXEL Device supports anti-probing, which prevents the ICMP response packet from being sent. This keeps outsiders from discovering your ZyXEL Device when unsupported ports are probed.

Figure 61 Remote Management: ICMP

The following table describes the labels in this screen.

Table 40 Remote Management: ICMP

LABEL	DESCRIPTION
ICMP	Internet Control Message Protocol is a message control and error-reporting protocol between a host server and a gateway to the Internet. ICMP uses Internet Protocol (IP) datagrams, but the messages are processed by the TCP/IP software and directly apparent to the application user.
Respond to Ping on	The ZyXEL Device will not respond to any incoming Ping requests when Disable is selected. Select LAN to reply to incoming LAN Ping requests. Select WAN to reply to incoming WAN Ping requests. Otherwise select LAN & WAN to reply to both incoming LAN and WAN Ping requests.
Apply	Click Apply to save your customized settings and exit this screen.
Cancel	Click Cancel to begin configuring this screen afresh.

CHAPTER 10

Universal Plug-and-Play (UPnP)

This chapter introduces the UPnP feature in the web configurator.

10.1 Introducing Universal Plug and Play

Universal Plug and Play (UPnP) is a distributed, open networking standard that uses TCP/IP for simple peer-to-peer network connectivity between devices. A UPnP device can dynamically join a network, obtain an IP address, convey its capabilities and learn about other devices on the network. In turn, a device can leave a network smoothly and automatically when it is no longer in use.

See [Section 10.2.1 on page 111](#) for configuration instructions.

10.1.1 How do I know if I'm using UPnP?

UPnP hardware is identified as an icon in the Network Connections folder (Windows XP). Each UPnP compatible device installed on your network will appear as a separate icon. Selecting the icon of a UPnP device will allow you to access the information and properties of that device.

10.1.2 NAT Traversal

UPnP NAT traversal automates the process of allowing an application to operate through NAT. UPnP network devices can automatically configure network addressing, announce their presence in the network to other UPnP devices and enable exchange of simple product and service descriptions. NAT traversal allows the following:

- Dynamic port mapping
- Learning public IP addresses
- Assigning lease times to mappings

Windows Messenger is an example of an application that supports NAT traversal and UPnP.

See the NAT chapter for more information on NAT.

10.1.3 Cautions with UPnP

The automated nature of NAT traversal applications in establishing their own services and opening firewall ports may present network security issues. Network information and configuration may also be obtained and modified by users in some network environments.

When a UPnP device joins a network, it announces its presence with a multicast message. For security reasons, the ZyXEL Device allows multicast messages on the LAN only.

All UPnP-enabled devices may communicate freely with each other without additional configuration. Disable UPnP if this is not your intention.

10.2 UPnP and ZyXEL

ZyXEL has achieved UPnP certification from the Universal Plug and Play Forum UPnP™ Implementers Corp. (UIC). ZyXEL's UPnP implementation supports Internet Gateway Device (IGD) 1.0.

See the following sections for examples of installing and using UPnP.

10.2.1 Configuring UPnP

Click **Advanced > UPnP** to display the screen shown next.

See [Section 10.1 on page 110](#) for more information.

Figure 62 Configuring UPnP

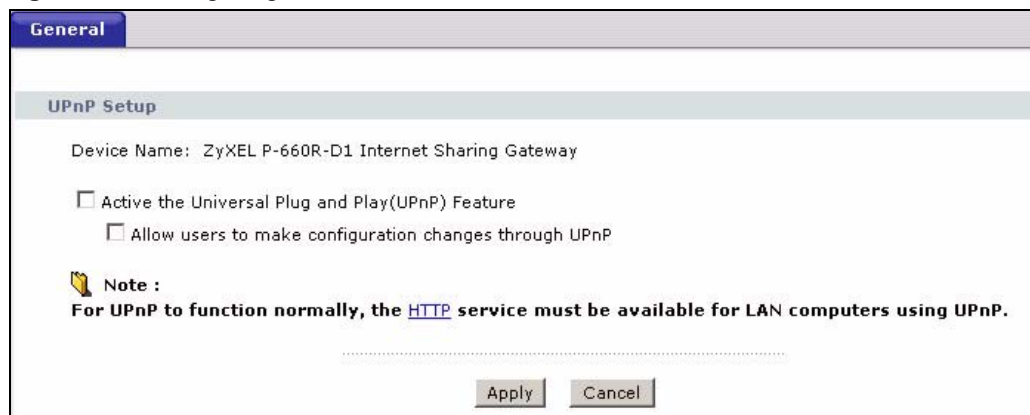

The following table describes the fields in this screen.

Table 41 Configuring UPnP

LABEL	DESCRIPTION
Active the Universal Plug and Play (UPnP) Feature	Select this check box to activate UPnP. Be aware that anyone could use a UPnP application to open the web configurator's login screen without entering the ZyXEL Device's IP address (although you must still enter the password to access the web configurator).
Allow users to make configuration changes through UPnP	Select this check box to allow UPnP-enabled applications to automatically configure the ZyXEL Device so that they can communicate through the ZyXEL Device, for example by using NAT traversal, UPnP applications automatically reserve a NAT forwarding port in order to communicate with another UPnP enabled device; this eliminates the need to manually configure port forwarding for the UPnP enabled application.
Apply	Click Apply to save the setting to the ZyXEL Device.
Cancel	Click Cancel to return to the previously saved settings.

10.3 Installing UPnP in Windows Example

This section shows how to install UPnP in Windows Me and Windows XP.

10.3.1 Installing UPnP in Windows Me

Follow the steps below to install the UPnP in Windows Me.

- 1 Click **Start** and **Control Panel**. Double-click **Add/Remove Programs**.
- 2 Click on the **Windows Setup** tab and select **Communication** in the **Components** selection box. Click **Details**.

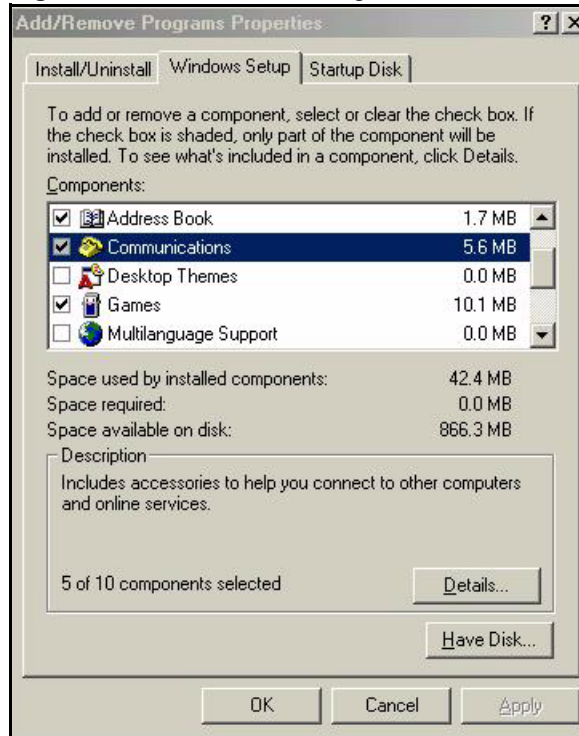
Figure 63 Add/Remove Programs: Windows Setup: Communication

- 3 In the **Communications** window, select the **Universal Plug and Play** check box in the **Components** selection box.

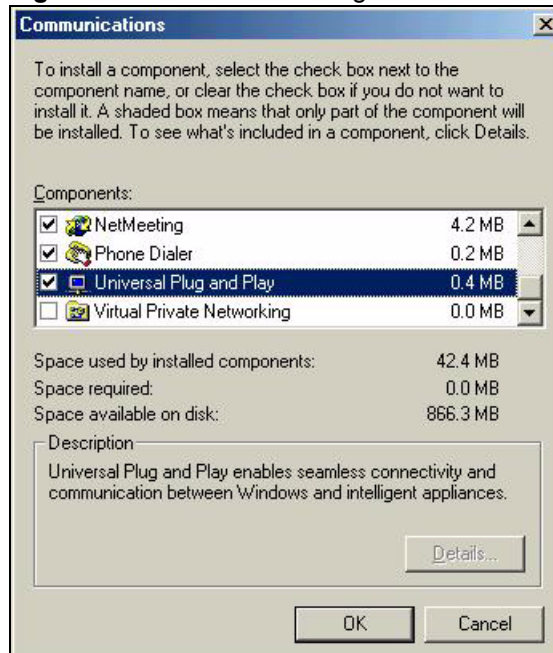
Figure 64 Add/Remove Programs: Windows Setup: Communication: Components

- 4 Click **OK** to go back to the **Add/Remove Programs Properties** window and click **Next**.
- 5 Restart the computer when prompted.

10.3.2 Installing UPnP in Windows XP

Follow the steps below to install the UPnP in Windows XP.

- 1 Click **start** and **Control Panel**.
- 2 Double-click **Network Connections**.
- 3 In the **Network Connections** window, click **Advanced** in the main menu and select **Optional Networking Components ...**.

Figure 65 Network Connections



- 4 The **Windows Optional Networking Components Wizard** window displays. Select **Networking Service** in the **Components** selection box and click **Details**.

Figure 66 Windows Optional Networking Components Wizard

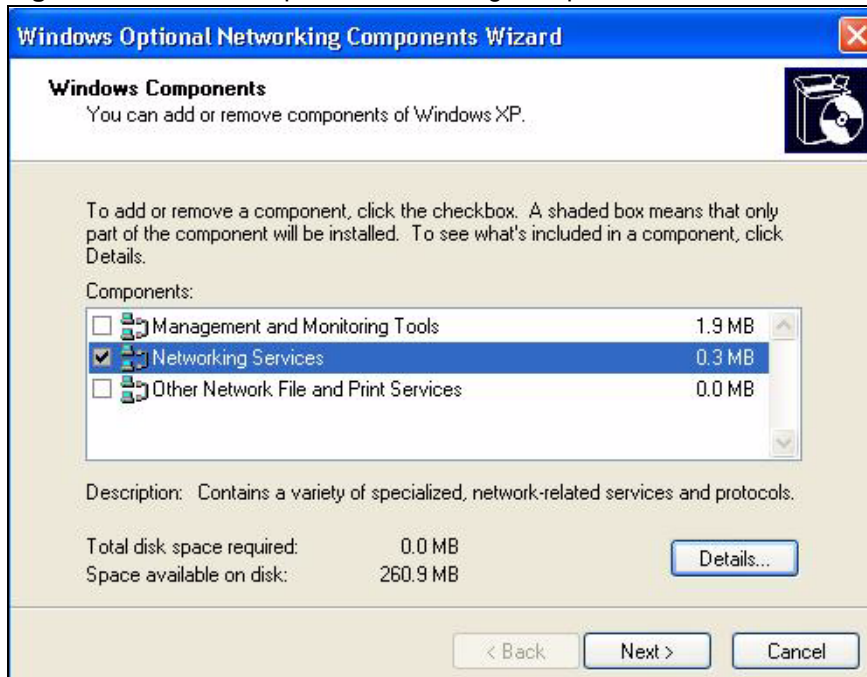

- 5 In the **Networking Services** window, select the **Universal Plug and Play** check box.

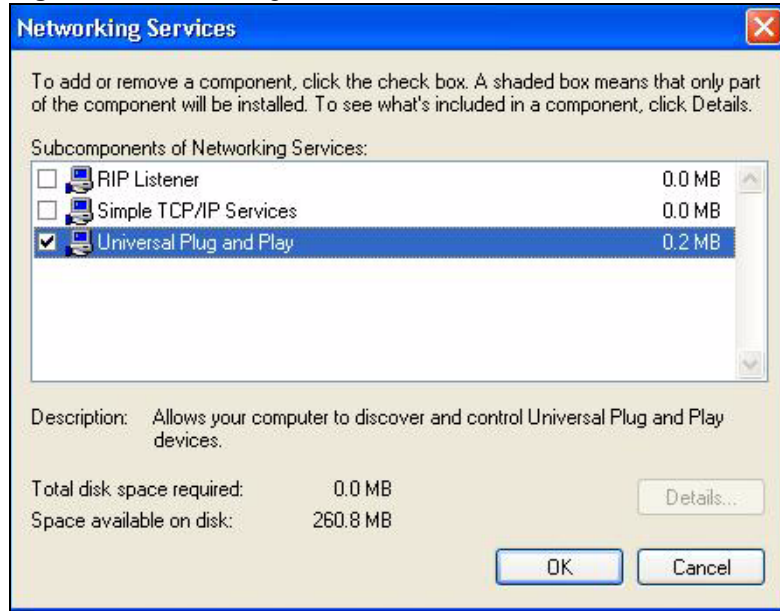
Figure 67 Networking Services

- 6 Click **OK** to go back to the **Windows Optional Networking Component Wizard** window and click **Next**.

10.4 Using UPnP in Windows XP Example

This section shows you how to use the UPnP feature in Windows XP. You must already have UPnP installed in Windows XP and UPnP activated on the ZyXEL Device.

Make sure the computer is connected to a LAN port of the ZyXEL Device. Turn on your computer and the ZyXEL Device.

10.4.1 Auto-discover Your UPnP-enabled Network Device

- 1 Click **start** and **Control Panel**. Double-click **Network Connections**. An icon displays under Internet Gateway.
- 2 Right-click the icon and select **Properties**.

Figure 68 Network Connections

- 3** In the **Internet Connection Properties** window, click **Settings** to see the port mappings there were automatically created.

Figure 69 Internet Connection Properties

- 4** You may edit or delete the port mappings or click **Add** to manually add port mappings.

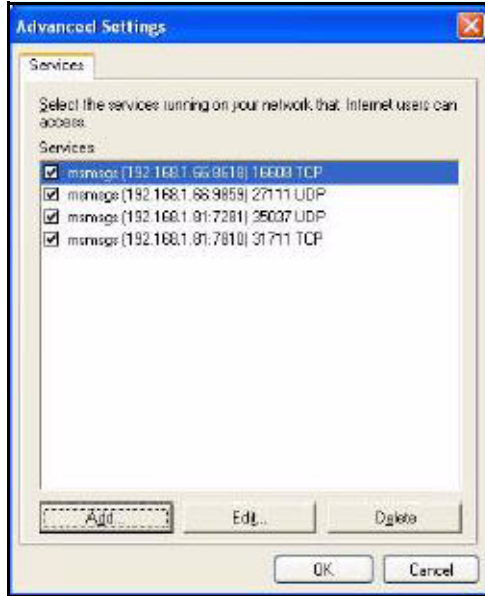
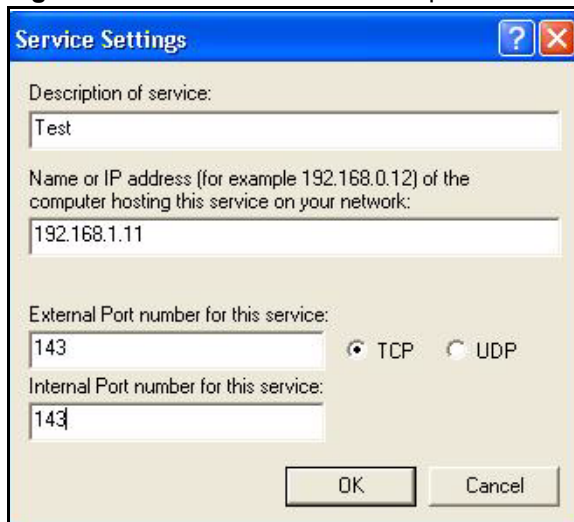
Figure 70 Internet Connection Properties: Advanced Settings**Figure 71** Internet Connection Properties: Advanced Settings: Add

Note: When the UPnP-enabled device is disconnected from your computer, all port mappings will be deleted automatically.

- 5 Select **Show icon in notification area when connected** option and click **OK**. An icon displays in the system tray.

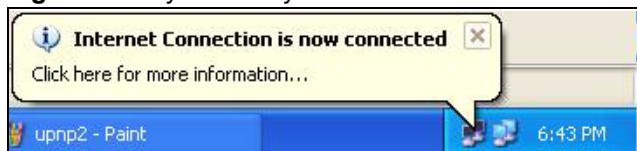
Figure 72 System Tray Icon

- 6 Double-click on the icon to display your current Internet connection status.

Figure 73 Internet Connection Status

10.4.2 Web Configurator Easy Access

With UPnP, you can access the web-based configurator on the ZyXEL Device without finding out the IP address of the ZyXEL Device first. This comes helpful if you do not know the IP address of the ZyXEL Device.

Follow the steps below to access the web configurator.

- 1** Click **Start** and then **Control Panel**.
- 2** Double-click **Network Connections**.
- 3** Select **My Network Places** under **Other Places**.

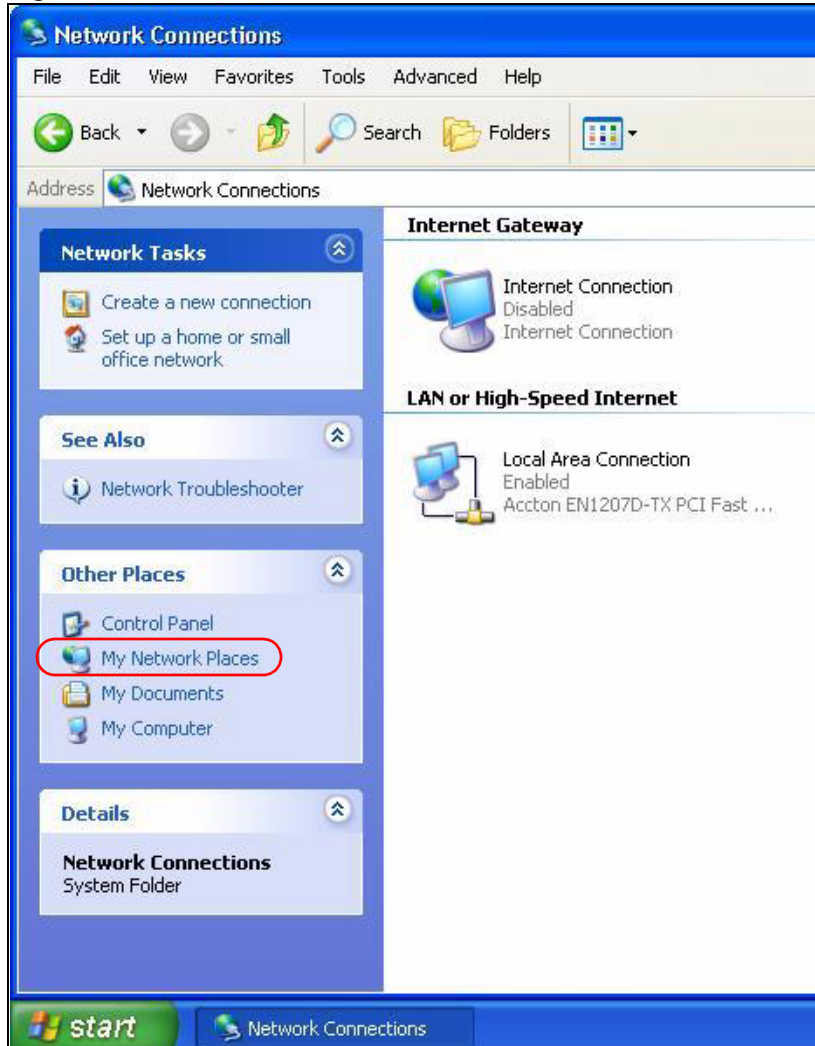
Figure 74 Network Connections

- 4 An icon with the description for each UPnP-enabled device displays under **Local Network**.
- 5 Right-click on the icon for your ZyXEL Device and select **Invoke**. The web configurator login screen displays.

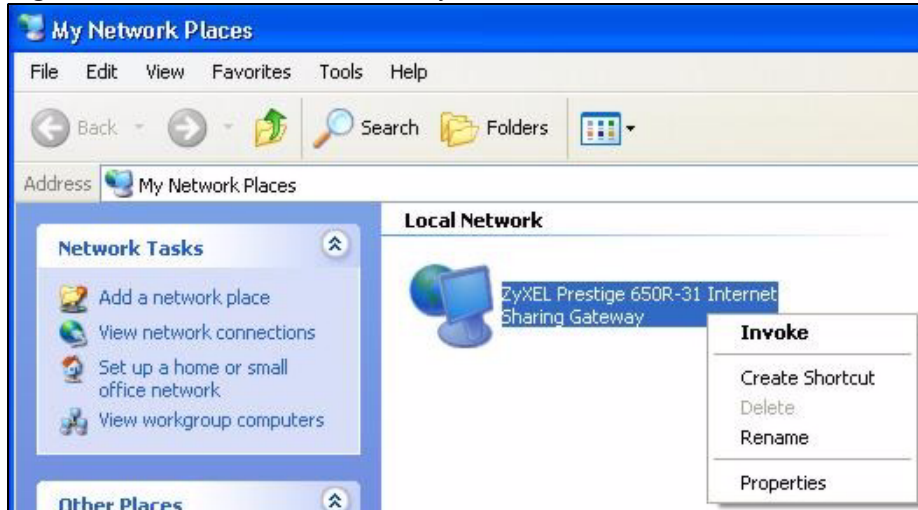
Figure 75 Network Connections: My Network Places

- 6 Right-click on the icon for your ZyXEL Device and select **Properties**. A properties window displays with basic information about the ZyXEL Device.

Figure 76 Network Connections: My Network Places: Properties: Example

CHAPTER 11

System

Use this screen to configure the ZyXEL Device's time and date settings.

11.1 General Setup

11.1.1 General Setup and System Name

General Setup contains administrative and system-related information. **System Name** is for identification purposes. However, because some ISPs check this name you should enter your computer's "Computer Name".

- In Windows 95/98 click **Start, Settings, Control Panel, Network**. Click the Identification tab, note the entry for the **Computer Name** field and enter it as the **System Name**.
- In Windows 2000, click **Start, Settings, Control Panel** and then double-click **System**. Click the **Network Identification** tab and then the **Properties** button. Note the entry for the **Computer name** field and enter it as the **System Name**.
- In Windows XP, click **start, My Computer, View system information** and then click the **Computer Name** tab. Note the entry in the **Full computer name** field and enter it as the ZyXEL Device **System Name**.

11.1.2 General Setup

The **Domain Name** entry is what is propagated to the DHCP clients on the LAN. If you leave this blank, the domain name obtained by DHCP from the ISP is used. While you must enter the host name (System Name), the domain name can be assigned from the ZyXEL Device via DHCP.

Click **Maintenance > System** to open the **General** screen.

Figure 77 System General Setup

The following table describes the labels in this screen.

Table 42 System General Setup

LABEL	DESCRIPTION
General Setup	
System Name	Choose a descriptive name for identification purposes. It is recommended you enter your computer's "Computer name" in this field. This name can be up to 30 alphanumeric characters long. Spaces are not allowed, but dashes "-" and underscores "_" are accepted.
Domain Name	Enter the domain name (if you know it) here. If you leave this field blank, the ISP may assign a domain name via DHCP. The domain name entered by you is given priority over the ISP assigned domain name.
Administrator Inactivity Timer	Type how many minutes a management session can be left idle before the session times out. The default is 5 minutes. After it times out you have to log in with your password again. Very long idle timeouts may have security risks. A value of "0" means a management session never times out, no matter how long it has been left idle (not recommended).
Password	
User Password	If you log in with the user password, you can only view the ZyXEL Device status. The default user password is user .
New Password	Type your new user password (up to 30 characters). Note that as you type a password, the screen displays a (*) for each character you type. After you change the password, use the new password to access the ZyXEL Device.
Retype to Confirm	Type the new password again for confirmation.

Table 42 System General Setup

LABEL	DESCRIPTION
Admin Password	If you log in with the admin password, you can configure the advanced features as well as the wizard setup on the ZyXEL Device.
Old Password	Type the default admin password (1234) or the existing password you use to access the system for configuring advanced features.
New Password	Type your new admin password (up to 30 characters). Note that as you type a password, the screen displays a (*) for each character you type. After you change the password, use the new password to access the ZyXEL Device.
Retype to Confirm	Type the new password again for confirmation.
Apply	Click Apply to save your changes back to the ZyXEL Device.
Cancel	Click Cancel to begin configuring this screen afresh.

11.2 Time Setting

To change your ZyXEL Device's time and date, click **Maintenance > System > Time Setting**. The screen appears as shown. Use this screen to configure the ZyXEL Device's time based on your local time zone.

Figure 78 System Time Setting

The following table describes the fields in this screen.

Table 43 System Time Setting

LABEL	DESCRIPTION
Current Time and Date	
Current Time	This field displays the time of your ZyXEL Device. Each time you reload this page, the ZyXEL Device synchronizes the time with the time server.
Current Date	This field displays the date of your ZyXEL Device. Each time you reload this page, the ZyXEL Device synchronizes the date with the time server.
Time and Date Setup	
Manual	Select this radio button to enter the time and date manually. If you configure a new time and date, Time Zone and Daylight Saving at the same time, the new time and date you entered has priority and the Time Zone and Daylight Saving settings do not affect it.
New Time (hh:mm:ss)	This field displays the last updated time from the time server or the last time configured manually. When you set Time and Date Setup to Manual , enter the new time in this field and then click Apply .
New Date (yyyy/mm/dd)	This field displays the last updated date from the time server or the last date configured manually. When you set Time and Date Setup to Manual , enter the new date in this field and then click Apply .
Get from Time Server	Select this radio button to have the ZyXEL Device get the time and date from the time server you specified below.
Time Protocol	Select the time service protocol that your time server uses. Not all time servers support all protocols, so you may have to check with your ISP/network administrator or use trial and error to find a protocol that works. The main difference between them is the format. Daytime (RFC 867) format is day/month/year/time zone of the server. Time (RFC 868) format displays a 4-byte integer giving the total number of seconds since 1970/1/1 at 0:0:0. The default, NTP (RFC 1305) , is similar to Time (RFC 868).
Time Server Address	Enter the IP address or URL (up to 20 extended ASCII characters in length) of your time server. Check with your ISP/network administrator if you are unsure of this information.
Time Zone Setup	
Time Zone	Choose the time zone of your location. This will set the time difference between your time zone and Greenwich Mean Time (GMT).
Enable Daylight Savings	Daylight saving is a period from late spring to early fall when many countries set their clocks ahead of normal local time by one hour to give more daytime light in the evening. Select this option if you use Daylight Saving Time.

Table 43 System Time Setting (continued)

LABEL	DESCRIPTION
Start Date	<p>Configure the day and time when Daylight Saving Time starts if you selected Enable Daylight Saving. The o'clock field uses the 24 hour format. Here are a couple of examples:</p> <p>Daylight Saving Time starts in most parts of the United States on the first Sunday of April. Each time zone in the United States starts using Daylight Saving Time at 2 A.M. local time. So in the United States you would select First, Sunday, April and type 2 in the o'clock field.</p> <p>Daylight Saving Time starts in the European Union on the last Sunday of March. All of the time zones in the European Union start using Daylight Saving Time at the same moment (1 A.M. GMT or UTC). So in the European Union you would select Last, Sunday, March. The time you type in the o'clock field depends on your time zone. In Germany for instance, you would type 2 because Germany's time zone is one hour ahead of GMT or UTC (GMT+1).</p>
End Date	<p>Configure the day and time when Daylight Saving Time ends if you selected Enable Daylight Saving. The o'clock field uses the 24 hour format. Here are a couple of examples:</p> <p>Daylight Saving Time ends in the United States on the last Sunday of October. Each time zone in the United States stops using Daylight Saving Time at 2 A.M. local time. So in the United States you would select Last, Sunday, October and type 2 in the o'clock field.</p> <p>Daylight Saving Time ends in the European Union on the last Sunday of October. All of the time zones in the European Union stop using Daylight Saving Time at the same moment (1 A.M. GMT or UTC). So in the European Union you would select Last, Sunday, October. The time you type in the o'clock field depends on your time zone. In Germany for instance, you would type 2 because Germany's time zone is one hour ahead of GMT or UTC (GMT+1).</p>
Apply	Click Apply to save your changes back to the ZyXEL Device.
Cancel	Click Cancel to begin configuring this screen afresh.

CHAPTER 12

Tools

This chapter describes how to upload new firmware, manage configuration and restart your ZyXEL Device.

12.1 Firmware Upgrade

Find firmware at www.zyxel.com in a file that (usually) uses the system model name with a .bin extension, for example, "ZyXEL Device.bin". The upload process uses HTTP (Hypertext Transfer Protocol) and may take up to two minutes. After a successful upload, the system will reboot.

Only use firmware for your device's specific model. Refer to the label on the bottom of your device.

Click **Maintenance > Tools** to open the **Firmware** screen. Follow the instructions in this screen to upload firmware to your ZyXEL Device.

Figure 79 Firmware Upgrade

The following table describes the labels in this screen.

Table 44 Firmware Upgrade

LABEL	DESCRIPTION
Current Firmware Version	This is the present Firmware version and the date created.
File Path	Type in the location of the file you want to upload in this field or click Browse ... to find it.

Table 44 Firmware Upgrade (continued)

LABEL	DESCRIPTION
Browse...	Click Browse... to find the .bin file you want to upload. Remember that you must decompress compressed (.zip) files before you can upload them.
Upload	Click Upload to begin the upload process. This process may take up to two minutes.

Note: Do NOT turn off the ZyXEL Device while firmware upload is in progress!

After you see the **Firmware Upload in Progress** screen, wait two minutes before logging into the ZyXEL Device again.

Figure 80 Firmware Upload In Progress



The ZyXEL Device automatically restarts in this time causing a temporary network disconnect. In some operating systems, you may see the following icon on your desktop.

Figure 81 Network Temporarily Disconnected



After two minutes, log in again and check your new firmware version in the **Status** screen.

If the upload was not successful, the following screen will appear. Click **Return** to go back to the **Firmware** screen.

Figure 82 Error Message

12.2 Configuration Screen

Click **Maintenance > Tools > Configuration**. Information related to factory defaults, backup configuration, and restoring configuration appears as shown next.

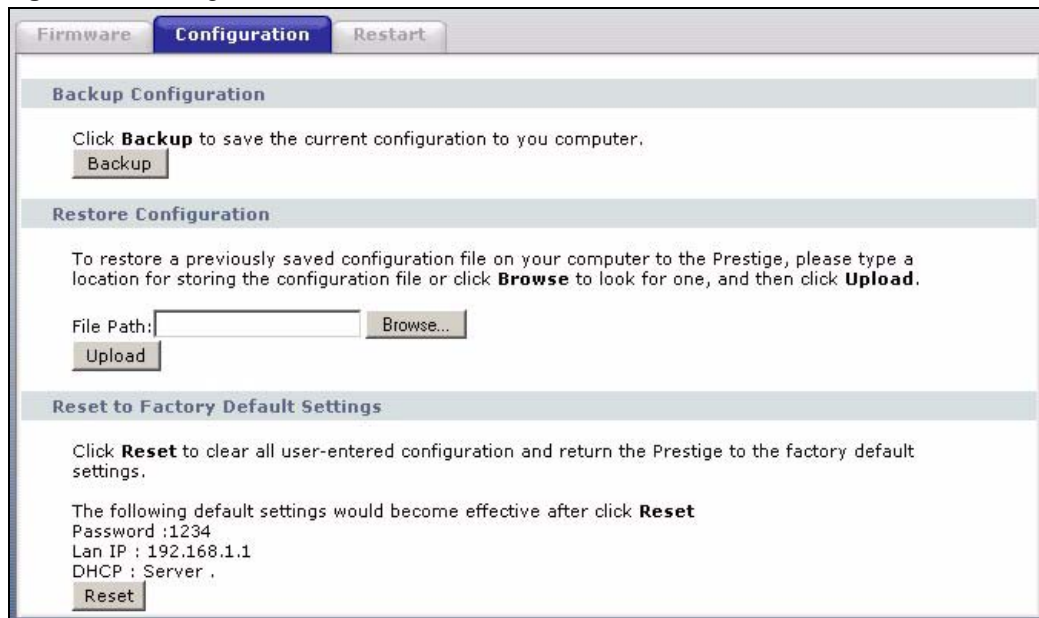
Figure 83 Configuration

12.2.1 Backup Configuration

Backup configuration allows you to back up (save) the ZyXEL Device's current configuration to a file on your computer. Once your ZyXEL Device is configured and functioning properly, it is highly recommended that you back up your configuration file before making configuration changes. The backup configuration file will be useful in case you need to return to your previous settings.

Click **Backup** to save the ZyXEL Device's current configuration to your computer

12.2.2 Restore Configuration

Restore configuration allows you to upload a new or previously saved configuration file from your computer to your ZyXEL Device.

Table 45 Maintenance Restore Configuration

LABEL	DESCRIPTION
File Path	Type in the location of the file you want to upload in this field or click Browse... to find it.
Browse...	Click Browse... to find the file you want to upload. Remember that you must decompress compressed (.ZIP) files before you can upload them.
Upload	Click Upload to begin the upload process.

Note: Do not turn off the ZyXEL Device while configuration file upload is in progress

After you see a “Restore Configuration successful” screen, you must then wait one minute before logging into the ZyXEL Device again.

Figure 84 Configuration Restore Successful



The ZyXEL Device automatically restarts in this time causing a temporary network disconnect. In some operating systems, you may see the following icon on your desktop.

Figure 85 Temporarily Disconnected



If you uploaded the default configuration file you may need to change the IP address of your computer to be in the same subnet as that of the default ZyXEL Device IP address (192.168.1.1). See the appendix for details on how to set up your computer's IP address.

If the upload was not successful, the following screen will appear. Click **Return** to go back to the **Configuration** screen.

Figure 86 Configuration Restore Error

12.2.3 Back to Factory Defaults

Pressing the **RESET** button in this section clears all user-entered configuration information and returns the ZyXEL Device to its factory defaults.

You can also press the **RESET** button on the rear panel to reset the factory defaults of your ZyXEL Device. Refer to the chapter about introducing the web configurator for more information on the **RESET** button.

12.3 Restart

System restart allows you to reboot the ZyXEL Device without turning the power off.

Click **Maintenance > Tools > Restart**. Click **Restart** to have the ZyXEL Device reboot. This does not affect the ZyXEL Device's configuration.

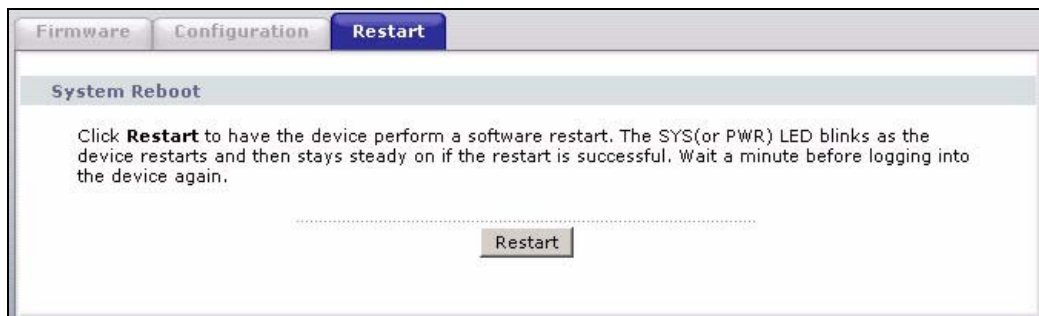
Figure 87 Restart Screen

CHAPTER 13

Diagnostic

These read-only screens display information to help you identify problems with the ZyXEL Device.

13.1 General Diagnostic

Click **Maintenance > Diagnostic** to open the screen shown next.

Figure 88 Diagnostic: General

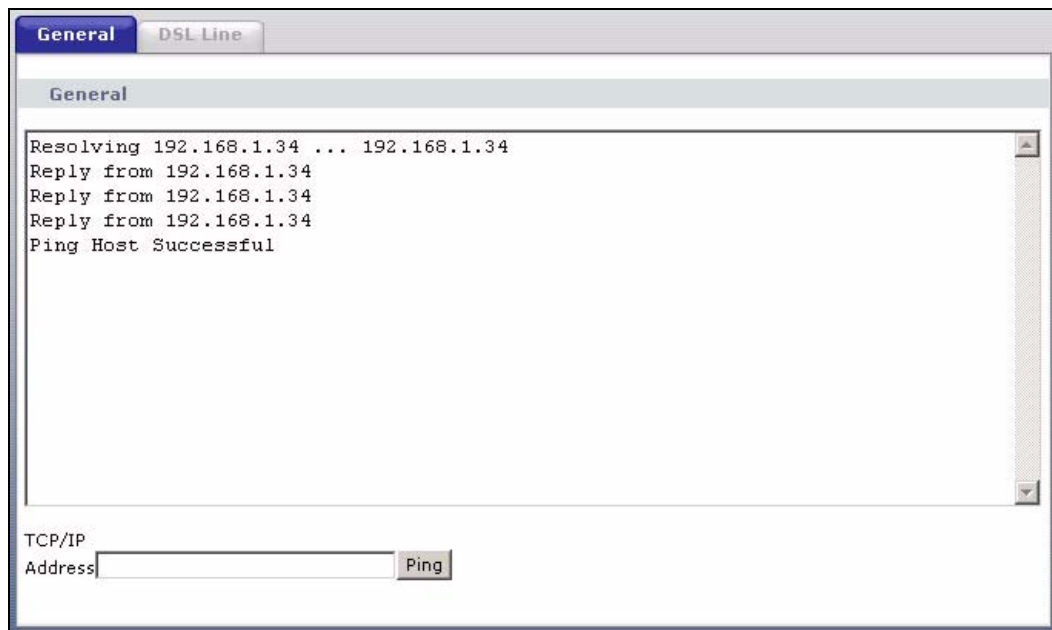

The following table describes the fields in this screen.

Table 46 Diagnostic: General

LABEL	DESCRIPTION
TCP/IP Address	Type the IP address of a computer that you want to ping in order to test a connection.
Ping	Click this button to ping the IP address that you entered.

13.2 DSL Line Diagnostic

Click **Maintenance > Diagnostic > DSL Line** to open the screen shown next.

Figure 89 Diagnostic: DSL Line



The following table describes the fields in this screen.

Table 47 Diagnostic: DSL Line

LABEL	DESCRIPTION
ATM Status	Click this button to view ATM status.
ATM Loopback Test	Click this button to start the ATM loopback test. Make sure you have configured at least one PVC with proper VPIs/VCIs before you begin this test. The ZyXEL Device sends an OAM F5 packet to the DSLAM/ATM switch and then returns it (loops it back) to the ZyXEL Device. The ATM loopback test is useful for troubleshooting problems with the DSLAM and ATM network.
DSL Line Status	Click this button to view the DSL port's line operating values and line bit allocation.
Reset ADSL Line	Click this button to reinitialize the ADSL line. The large text box above then displays the progress and results of this operation, for example: "Start to reset ADSL Loading ADSL modem F/W... Reset ADSL Line Successfully!"
Capture All Logs	Click this button to display all logs generated with the DSL line.

CHAPTER 14

Troubleshooting

This chapter covers potential problems and the corresponding remedies.

14.1 Problems Starting Up the ZyXEL Device

Table 48 Troubleshooting Starting Up Your ZyXEL Device

PROBLEM	CORRECTIVE ACTION
None of the lights turn on when I turn on the ZyXEL Device.	<p>Make sure that the ZyXEL Device's power adaptor is connected to the ZyXEL Device and plugged in to an appropriate power source. Make sure that the ZyXEL Device and the power source are both turned on.</p> <p>Turn the ZyXEL Device off and on.</p> <p>If the error persists, you may have a hardware problem. In this case, you should contact your vendor.</p>

14.2 Problems with the LAN

Table 49 Troubleshooting the LAN

PROBLEM	CORRECTIVE ACTION
The LAN lights do not turn on.	<p>Check your Ethernet cable connections (refer to the Quick Start Guide for details). Check for faulty Ethernet cables.</p>
	<p>Make sure your computer's Ethernet Card is working properly.</p>
I cannot access the ZyXEL Device from the LAN.	<p>If Any IP is disabled, make sure that the IP address and the subnet mask of the ZyXEL Device and your computer(s) are on the same subnet.</p>

14.3 Problems with the WAN

Table 50 Troubleshooting the WAN

PROBLEM	CORRECTIVE ACTION
The DSL light is off.	Check the telephone wire and connections between the ZyXEL Device DSL port and the wall jack.
	Make sure that the telephone company has checked your phone line and set it up for DSL service.
	Reset your ADSL line to reinitialize your link to the DSLAM. For details, refer to Table 47 on page 135 .
I cannot get a WAN IP address from the ISP.	The ISP provides the WAN IP address after authenticating you. Authentication may be through the user name and password, the MAC address or the host name. The username and password apply to PPPoE and PPPoA encapsulation only. Make sure that you have entered the correct Service Type, User Name and Password (be sure to use the correct casing). Refer to the WAN Setup chapter.
I cannot access the Internet.	Make sure the ZyXEL Device is turned on and connected to the network. Verify your WAN settings. Refer to the chapter on WAN setup. Make sure you entered the correct user name and password. If you use PPPoE pass through, make sure that bridge mode is turned on.
The Internet connection disconnects.	Check the schedule rules. If you use PPPoA or PPPoE encapsulation, check the idle time-out setting. Refer to Chapter 4 on page 48 . Contact your ISP.

14.4 Problems Accessing the ZyXEL Device

Table 51 Troubleshooting Accessing the ZyXEL Device

PROBLEM	CORRECTIVE ACTION
I cannot access the ZyXEL Device.	<p>The default user password is "user" and admin password is "1234". The Password field is case-sensitive. Make sure that you enter the correct password using the proper case.</p> <p>If you have changed the password and have now forgotten it, you will need to upload the default configuration file. This restores all of the factory defaults including the password.</p>
I cannot access the web configurator.	<p>Make sure that there is not a Telnet session running.</p> <p>Use the ZyXEL Device's WAN IP address when configuring from the WAN. Refer to the instructions on checking your WAN connection.</p> <p>Use the ZyXEL Device's LAN IP address when configuring from the LAN. Refer to for instructions on checking your LAN connection.</p> <p>Check that you have enabled web service access. If you have configured a secured client IP address, your computer's IP address must match it. Refer to the chapter on remote management for details.</p> <p>Your computer's and the ZyXEL Device's IP addresses must be on the same subnet for LAN access.</p> <p>If you changed the ZyXEL Device's LAN IP address, then enter the new one as the URL.</p> <p>Make sure that pop-up windows, JavaScripts and Java permissions are allowed. See the appendix for how to enable them.</p>

APPENDIX A

Product Specifications

See also the Introduction chapter for a general overview of the key features.

Specification Tables

Table 52 Device

Default IP Address	192.168.1.1
Default Subnet Mask	255.255.255.0 (24 bits)
Default Password	administrator: 1234 user: user
DHCP Pool	192.168.1.33 to 192.168.1.64
Dimensions (W x D x H)	105 x 105 x 31 mm
Power Specification	9VAC 1A
Ethernet port	auto MDI/MDI-X 10/100 Mbps RJ-45 Ethernet port
Operation Temperature	0° C ~ 40° C
Storage Temperature	-30° ~ 60° C
Operation Humidity	20% ~ 85% RH
Storage Humidity	20% ~ 90% RH
Distance between the centers of the holes on the device's back.	75 mm
Screw size for wall-mounting	M3*10

Table 53 Firmware

ADSL Standards	<p>Multi-Mode standard (ANSI T1.413, Issue 2; G.dmt(G.992.1); G.lite(G.992.2)).</p> <p>ADSL2 G.dmt.bis (G.992.3)</p> <p>ADSL2 G.lite.bis (G.992.4)</p> <p>ADSL2+ (G.992.5)</p> <p>Reach-Extended ADSL (RE ADSL)</p> <p>SRA (Seamless Rate Adaptation)</p> <p>Auto-negotiating rate adaptation</p> <p>ADSL physical connection ATM AAL5 (ATM Adaptation Layer type 5)</p> <p>Multi-protocol over AAL5 (RFC2684/1483)</p> <p>PPP over ATM AAL5 (RFC 2364)</p> <p>PPP over Ethernet (RFC 2516)</p> <p>RFC 1483 encapsulation over ATM</p> <p>MAC encapsulated routing (ENET encapsulation)</p> <p>VC-based and LLC-based multiplexing</p> <p>Up to 8 PVCs (Permanent Virtual Circuits)</p> <p>I.610 F4/F5 OAM</p>
Other Protocol Support	<p>PPP (Point-to-Point Protocol) link layer protocol.</p> <p>Transparent bridging for unsupported network layer protocols.</p> <p>DHCP Server/Client/Relay</p> <p>RIP I/RIP II</p> <p>ICMP</p> <p>SNMP v1 and v2c with MIB II support (RFC 1213)</p> <p>IP Multicasting IGMP v1 and v2</p> <p>IGMP Proxy</p> <p>UPnP</p>
Management	<p>Embedded Web Configurator</p> <p>CLI (Command Line Interpreter)</p> <p>Remote Management via Telnet or Web</p> <p>SNMP manageable</p> <p>FTP/TFTP for firmware downloading, configuration backup and restoration.</p> <p>Built-in Diagnostic Tools for FLASH memory, ADSL circuitry, RAM and LAN port</p> <p>MAP - "Multimedia Auto Provisioner" (multimedia installation tutorial and automatic configurator)</p>
NAT/SUA	<p>Port Forwarding</p> <p>1024 NAT sessions</p> <p>Multimedia application</p> <p>PPTP under NAT/SUA</p>
Static Routes	16 IP and 4 Bridge
Other Features	<p>Any IP</p> <p>Zero Configuration (VC auto-hunting)</p> <p>Traffic Redirect</p> <p>Dynamic DNS</p> <p>IP Alias</p>

APPENDIX B

Internal SPTGEN

This appendix introduces Internal SPTGEN. All menus shown in this appendix are example menus meant to show SPTGEN usage. Actual menus for your product may differ.

Internal SPTGEN Overview

Internal SPTGEN (System Parameter Table Generator) is a configuration text file useful for efficient configuration of multiple ZyXEL Devices. Internal SPTGEN lets you configure, save and upload multiple menus at the same time using just one configuration text file – eliminating the need to navigate and configure individual screens for each ZyXEL Device. You can use FTP to get the Internal SPTGEN file. Then edit the file in a text editor and use FTP to upload it again to the same device or another one. See the following sections for details.

The Configuration Text File Format

All Internal SPTGEN text files conform to the following format:

```
<field identification number = field name = parameter values
allowed = input>,
```

where <input> is your input conforming to <parameter values allowed>.

The figure shown next is an example of an Internal SPTGEN text file.

Figure 90 Configuration Text File Format: Column Descriptions

/ Menu 1 General Setup		
10000000 = Configured	<0 (No) 1 (Yes)>	= 1
10000001 = System Name	<Str>	= Your Device
10000002 = Location	<Str>	=
10000003 = Contact Person's Name	<Str>	=
10000004 = Route IP	<0 (No) 1 (Yes)>	= 1
10000005 = Route IPX	<0 (No) 1 (Yes)>	= 0
10000006 = Bridge	<0 (No) 1 (Yes)>	= 0

Note: DO NOT alter or delete any field except parameters in the Input column.

This appendix introduces Internal SPTGEN. All menus shown in this appendix are example menus meant to show SPTGEN usage. Actual menus for your product may differ.

Internal SPTGEN File Modification - Important Points to Remember

Each parameter you enter must be preceded by one “=” sign and one space.

Some parameters are dependent on others. For example, if you disable the **Configured** field in menu 1 (see [Figure 90 on page 142](#)), then you disable every field in this menu.

If you enter a parameter that is invalid in the **Input** column, the ZyXEL Device will not save the configuration and the command line will display the **Field Identification Number**. [Figure 91 on page 143](#), shown next, is an example of what the ZyXEL Device displays if you enter a value other than “0” or “1” in the **Input** column of **Field Identification Number 1000000** (refer to [Figure 90 on page 142](#)).

Figure 91 Invalid Parameter Entered: Command Line Example

```
field value is not legal error:-1
ROM-t is not saved, error Line ID:10000000
reboot to get the original configuration
Bootbase Version: V2.02 | 2/22/2001 13:33:11
RAM: Size = 8192 Kbytes
FLASH: Intel 8M *2
```

The ZyXEL Device will display the following if you enter parameter(s) that *are* valid.

Figure 92 Valid Parameter Entered: Command Line Example

```
Please wait for the system to write SPT text file(ROM-t)...
Bootbase Version: V2.02 | 2/22/2001 13:33:11
RAM: Size = 8192 Kbytes
FLASH: Intel 8M *2
```

Internal SPTGEN FTP Download Example

- 1 Launch your FTP application.
- 2 Enter "bin". The command “bin” sets the transfer mode to binary.
- 3 Get "rom-t" file. The command “get” transfers files from the ZyXEL Device to your computer. The name “rom-t” is the configuration filename on the ZyXEL Device.
- 4 Edit the "rom-t" file using a text editor (do not use a word processor). You must leave this FTP screen to edit.

Figure 93 Internal SPTGEN FTP Download Example

```
c:\ftp 192.168.1.1
220 PPP FTP version 1.0 ready at Sat Jan 1 03:22:12 2000
User (192.168.1.1:(none)):
331 Enter PASS command
Password:
230 Logged in
ftp>bin
200 Type I OK
ftp> get rom-t
ftp>bye
c:\edit rom-t
(edit the rom-t text file by a text editor and save it)
```

Note: You can rename your “rom-t” file when you save it to your computer but it must be named “rom-t” when you upload it to your ZyXEL Device.

Internal SPTGEN FTP Upload Example

- 1 Launch your FTP application.
- 2 Enter "bin". The command “bin” sets the transfer mode to binary.
- 3 Upload your “rom-t” file from your computer to the ZyXEL Device using the “put” command. computer to the ZyXEL Device.
- 4 Exit this FTP application.

Figure 94 Internal SPTGEN FTP Upload Example

```
c:\ftp 192.168.1.1
220 PPP FTP version 1.0 ready at Sat Jan 1 03:22:12 2000
User (192.168.1.1:(none)):
331 Enter PASS command
Password:
230 Logged in
ftp>bin
200 Type I OK
ftp> put rom-t
ftp>bye
```

Example Internal SPTGEN Menus

This section provides example Internal SPTGEN menus.

Table 54 Abbreviations Used in the Example Internal SPTGEN Screens Table

ABBREVIATION	MEANING
FIN	Field Identification Number
FN	Field Name
PVA	Parameter Values Allowed
INPUT	An example of what you may enter
*	Applies to the ZyXEL Device.

Table 55 Menu 1 General Setup

/ Menu 1 General Setup			
FIN	FN	PVA	INPUT
10000000 =	Configured	<0 (No) 1 (Yes)>	= 0
10000001 =	System Name	<Str>	= Your Device
10000002 =	Location	<Str>	=
10000003 =	Contact Person's Name	<Str>	=
10000004 =	Route IP	<0 (No) 1 (Yes)>	= 1
10000006 =	Bridge	<0 (No) 1 (Yes)>	= 0

Table 56 Menu 3

/ Menu 3.1 General Ethernet Setup			
FIN	FN	PVA	INPUT
30100001 =	Input Protocol filters Set 1		= 2
30100002 =	Input Protocol filters Set 2		= 256
30100003 =	Input Protocol filters Set 3		= 256
30100004 =	Input Protocol filters Set 4		= 256
30100005 =	Input device filters Set 1		= 256
30100006 =	Input device filters Set 2		= 256
30100007 =	Input device filters Set 3		= 256
30100008 =	Input device filters Set 4		= 256
30100009 =	Output protocol filters Set 1		= 256
30100010 =	Output protocol filters Set 2		= 256
30100011 =	Output protocol filters Set 3		= 256

Table 56 Menu 3

30100012 =	Output protocol filters Set 4		= 256
30100013 =	Output device filters Set 1		= 256
30100014 =	Output device filters Set 2		= 256
30100015 =	Output device filters Set 3		= 256
30100016 =	Output device filters Set 4		= 256
/ Menu 3.2 TCP/IP and DHCP Ethernet Setup			
FIN	FN	PVA	INPUT
30200001 =	DHCP	<0 (None) 1 (Server) 2 (Relay)>	= 0
30200002 =	Client IP Pool Starting Address		= 192.168.1.33
30200003 =	Size of Client IP Pool		= 32
30200004 =	Primary DNS Server		= 0.0.0.0
30200005 =	Secondary DNS Server		= 0.0.0.0
30200006 =	Remote DHCP Server		= 0.0.0.0
30200008 =	IP Address		= 172.21.2.200
30200009 =	IP Subnet Mask		= 16
30200010 =	RIP Direction	<0 (None) 1 (Both) 2 (In Only) 3 (Out Only)>	= 0
30200011 =	Version	<0 (Rip-1) 1 (Rip-2B) 2 (Rip-2M)>	= 0
30200012 =	Multicast	<0 (IGMP-v2) 1 (IGMP-v1) 2 (None)>	= 2
30200013 =	IP Policies Set 1 (1~12)		= 256
30200014 =	IP Policies Set 2 (1~12)		= 256
30200015 =	IP Policies Set 3 (1~12)		= 256
30200016 =	IP Policies Set 4 (1~12)		= 256
/ Menu 3.2.1 IP Alias Setup			
FIN	FN	PVA	INPUT
30201001 =	IP Alias 1	<0 (No) 1 (Yes)>	= 0
30201002 =	IP Address		= 0.0.0.0
30201003 =	IP Subnet Mask		= 0
30201004 =	RIP Direction	<0 (None) 1 (Both) 2 (In Only) 3 (Out Only)>	= 0

Table 56 Menu 3

30201005 =	Version	<0 (Rip-1) 1 (Rip-2B) 2 (Rip-2M) >	= 0
30201006 =	IP Alias #1 Incoming protocol filters Set 1		= 256
30201007 =	IP Alias #1 Incoming protocol filters Set 2		= 256
30201008 =	IP Alias #1 Incoming protocol filters Set 3		= 256
30201009 =	IP Alias #1 Incoming protocol filters Set 4		= 256
30201010 =	IP Alias #1 Outgoing protocol filters Set 1		= 256
30201011 =	IP Alias #1 Outgoing protocol filters Set 2		= 256
30201012 =	IP Alias #1 Outgoing protocol filters Set 3		= 256
30201013 =	IP Alias #1 Outgoing protocol filters Set 4		= 256
30201014 =	IP Alias 2 <0 (No) 1 (Yes) >		= 0
30201015 =	IP Address		= 0.0.0.0
30201016 =	IP Subnet Mask		= 0
30201017 =	RIP Direction	<0 (None) 1 (Both) 2 (In Only) 3 (Out Only) >	= 0
30201018 =	Version	<0 (Rip-1) 1 (Rip-2B) 2 (Rip-2M) >	= 0
30201019 =	IP Alias #2 Incoming protocol filters Set 1		= 256
30201020 =	IP Alias #2 Incoming protocol filters Set 2		= 256
30201021 =	IP Alias #2 Incoming protocol filters Set 3		= 256
30201022 =	IP Alias #2 Incoming protocol filters Set 4		= 256
30201023 =	IP Alias #2 Outgoing protocol filters Set 1		= 256
30201024 =	IP Alias #2 Outgoing protocol filters Set 2		= 256
30201025 =	IP Alias #2 Outgoing protocol filters Set 3		= 256
30201026 =	IP Alias #2 Outgoing protocol filters Set 4		= 256
*/ Menu 3.5 Wireless LAN Setup			

Table 56 Menu 3

FIN	FN	PVA	INPUT
30500001 =	ESSID		Wireless
30500002 =	Hide ESSID	<0 (No) 1 (Yes)>	= 0
30500003 =	Channel ID	<1 2 3 4 5 6 7 8 9 10 11 12 13>	= 1
30500004 =	RTS Threshold	<0 ~ 2432>	= 2432
30500005 =	FRAG. Threshold	<256 ~ 2432>	= 2432
30500006 =	WEP	<0 (DISABLE) 1 (64-bit WEP) 2 (128-bit WEP)>	= 0
30500007 =	Default Key	<1 2 3 4>	= 0
30500008 =	WEP Key1		=
30500009 =	WEP Key2		=
30500010 =	WEP Key3		=
30500011 =	WEP Key4		=
30500012 =	Wlan Active	<0 (Disable) 1 (Enable)>	= 0
30500013 =	Wlan 4X Mode	<0 (Disable) 1 (Enable)>	= 0
*/ MENU 3.5.1 WLAN MAC ADDRESS FILTER			
FIN	FN	PVA	INPUT
30501001 =	Mac Filter Active	<0 (No) 1 (Yes)>	= 0
30501002 =	Filter Action	<0 (Allow) 1 (Deny)>	= 0
30501003 =	Address 1		= 00:00:00:00:0 0:00
30501004 =	Address 2		= 00:00:00:00:0 0:00
30501005 =	Address 3		= 00:00:00:00:0 0:00
Continued
30501034 =	Address 32		= 00:00:00:00:0 0:00

Table 57 Menu 4 Internet Access Setup

/ Menu 4 Internet Access Setup			
FIN	FN	PVA	INPUT
40000000 =	Configured	<0 (No) 1 (Yes)>	= 1
40000001 =	ISP	<0 (No) 1 (Yes)>	= 1
40000002 =	Active	<0 (No) 1 (Yes)>	= 1
40000003 =	ISP's Name		= ChangeMe
40000004 =	Encapsulation	<2 (PPPOE) 3 (RFC 1483) 4 (PPPoA) 5 (ENET ENCAP)>	= 2
40000005 =	Multiplexing	<1 (LLC-based) 2 (VC-based)>	= 1
40000006 =	VPI #		= 0
40000007 =	VCI #		= 35
40000008 =	Service Name	<Str>	= any
40000009 =	My Login	<Str>	= test@pqa
40000010 =	My Password	<Str>	= 1234
40000011 =	Single User Account	<0 (No) 1 (Yes)>	= 1
40000012 =	IP Address Assignment	<0 (Static) 1 (D ynamic)>	= 1
40000013 =	IP Address		= 0.0.0.0
40000014 =	Remote IP address		= 0.0.0.0
40000015 =	Remote IP subnet mask		= 0
40000016 =	ISP incoming protocol filter set 1		= 6
40000017 =	ISP incoming protocol filter set 2		= 256
40000018 =	ISP incoming protocol filter set 3		= 256
40000019 =	ISP incoming protocol filter set 4		= 256
40000020 =	ISP outgoing protocol filter set 1		= 256
40000021 =	ISP outgoing protocol filter set 2		= 256
40000022 =	ISP outgoing protocol filter set 3		= 256
40000023 =	ISP outgoing protocol filter set 4		= 256
40000024 =	ISP PPPoE idle timeout		= 0
40000025 =	Route IP	<0 (No) 1 (Yes)>	= 1
40000026 =	Bridge	<0 (No) 1 (Yes)>	= 0

Table 57 Menu 4 Internet Access Setup (continued)

40000027 =	ATM QoS Type	<0 (CBR) 1 (UBR)>	= 1
40000028 =	Peak Cell Rate (PCR)		= 0
40000029 =	Sustain Cell Rate (SCR)		= 0
40000030 =	Maximum Burst Size (MBS)		= 0
40000031 =	RIP Direction	<0 (None) 1 (Both) 2 (In Only) 3 (Out Only)>	= 0
40000032 =	RIP Version	<0 (Rip-1) 1 (Rip-2B) 2 (Rip-2M)>	= 0
40000033 =	Nailed-up Connection	<0 (No) 1 (Yes)>	= 0

Table 58 Menu 12

/ Menu 12.1.1 IP Static Route Setup			
FIN	FN	PVA	INPUT
120101001 =	IP Static Route set #1, Name	<Str>	=
120101002 =	IP Static Route set #1, Active	<0 (No) 1 (Yes)>	= 0
120101003 =	IP Static Route set #1, Destination IP address		= 0.0.0.0
120101004 =	IP Static Route set #1, Destination IP subnetmask		= 0
120101005 =	IP Static Route set #1, Gateway		= 0.0.0.0
120101006 =	IP Static Route set #1, Metric		= 0
120101007 =	IP Static Route set #1, Private	<0 (No) 1 (Yes)>	= 0
/ Menu 12.1.2 IP Static Route Setup			
FIN	FN	PVA	INPUT
120108001 =	IP Static Route set #8, Name	<Str>	=
120108002 =	IP Static Route set #8, Active	<0 (No) 1 (Yes)>	= 0
120108003 =	IP Static Route set #8, Destination IP address		= 0.0.0.0
120108004 =	IP Static Route set #8, Destination IP subnetmask		= 0
120108005 =	IP Static Route set #8, Gateway		= 0.0.0.0
120108006 =	IP Static Route set #8, Metric		= 0
120108007 =	IP Static Route set #8, Private	<0 (No) 1 (Yes)>	= 0

Table 59 Menu 15 SUA Server Setup

/ Menu 15 SUA Server Setup			
FIN	FN	PVA	INPUT
150000001 =	SUA Server IP address for default port		= 0.0.0.0
150000002 =	SUA Server #2 Active	<0 (No) 1 (Yes)>	= 0
150000003 =	SUA Server #2 Protocol	<0 (All) 6 (TCP) 17 (UDP)>	= 0
150000004 =	SUA Server #2 Port Start		= 0
150000005 =	SUA Server #2 Port End		= 0
150000006 =	SUA Server #2 Local IP address		= 0.0.0.0
150000007 =	SUA Server #3 Active	<0 (No) 1 (Yes)>	= 0
150000008 =	SUA Server #3 Protocol	<0 (All) 6 (TCP) 17 (UDP)>	= 0
150000009 =	SUA Server #3 Port Start		= 0
150000010 =	SUA Server #3 Port End		= 0
150000011 =	SUA Server #3 Local IP address		= 0.0.0.0
150000012 =	SUA Server #4 Active	<0 (No) 1 (Yes)>	= 0
150000013 =	SUA Server #4 Protocol	<0 (All) 6 (TCP) 17 (UDP)>	= 0
150000014 =	SUA Server #4 Port Start		= 0
150000015 =	SUA Server #4 Port End		= 0
150000016 =	SUA Server #4 Local IP address		= 0.0.0.0
150000017 =	SUA Server #5 Active	<0 (No) 1 (Yes)>	= 0
150000018 =	SUA Server #5 Protocol	<0 (All) 6 (TCP) 17 (UDP)>	= 0
150000019 =	SUA Server #5 Port Start		= 0
150000020 =	SUA Server #5 Port End		= 0
150000021 =	SUA Server #5 Local IP address		= 0.0.0.0
150000022 =	SUA Server #6 Active	<0 (No) 1 (Yes)> = 0	= 0
150000023 =	SUA Server #6 Protocol	<0 (All) 6 (TCP) 17 (UDP)>	= 0
150000024 =	SUA Server #6 Port Start		= 0
150000025 =	SUA Server #6 Port End		= 0
150000026 =	SUA Server #6 Local IP address		= 0.0.0.0
150000027 =	SUA Server #7 Active	<0 (No) 1 (Yes)>	= 0
150000028 =	SUA Server #7 Protocol	<0 (All) 6 (TCP) 17 (UDP)>	= 0.0.0.0
150000029 =	SUA Server #7 Port Start		= 0
150000030 =	SUA Server #7 Port End		= 0

Table 59 Menu 15 SUA Server Setup (continued)

150000031 =	SUA Server #7 Local IP address		= 0.0.0.0
150000032 =	SUA Server #8 Active	<0 (No) 1 (Yes)>	= 0
150000033 =	SUA Server #8 Protocol	<0 (All) 6 (TCP) 17 (UDP)>	= 0
150000034 =	SUA Server #8 Port Start		= 0
150000035 =	SUA Server #8 Port End		= 0
150000036 =	SUA Server #8 Local IP address		= 0.0.0.0
150000037 =	SUA Server #9 Active	<0 (No) 1 (Yes)>	= 0
150000038 =	SUA Server #9 Protocol	<0 (All) 6 (TCP) 17 (UDP)>	= 0
150000039 =	SUA Server #9 Port Start		= 0
150000040 =	SUA Server #9 Port End		= 0
150000041 =	SUA Server #9 Local IP address		= 0.0.0.0
150000042 =	SUA Server #10 Active	<0 (No) 1 (Yes)>	= 0
150000043 =	SUA Server #10 Protocol	<0 (All) 6 (TCP) 17 (UDP)>	= 0
150000044 =	SUA Server #10 Port Start		= 0
150000045 =	SUA Server #10 Port End		= 0
150000046 =	SUA Server #10 Local IP address		= 0.0.0.0
150000047 =	SUA Server #11 Active	<0 (No) 1 (Yes)>	= 0
150000048 =	SUA Server #11 Protocol	<0 (All) 6 (TCP) 17 (UDP)>	= 0
150000049 =	SUA Server #11 Port Start		= 0
150000050 =	SUA Server #11 Port End		= 0
150000051 =	SUA Server #11 Local IP address		= 0.0.0.0
150000052 =	SUA Server #12 Active	<0 (No) 1 (Yes)>	= 0
150000053 =	SUA Server #12 Protocol	<0 (All) 6 (TCP) 17 (UDP)>	= 0
150000054 =	SUA Server #12 Port Start		= 0
150000055 =	SUA Server #12 Port End		= 0
150000056 =	SUA Server #12 Local IP address		= 0.0.0.0

Table 60 Menu 21.1 Filter Set #1

/ Menu 21 Filter set #1			
FIN	FN	PVA	INPUT
210100001 =	Filter Set 1, Name	<Str>	=
/ Menu 21.1.1.1 set #1, rule #1			
FIN	FN	PVA	INPUT
210101001 =	IP Filter Set 1, Rule 1 Type	<2 (TCP/IP)>	= 2

Table 60 Menu 21.1 Filter Set #1 (continued)

210101002 =	IP Filter Set 1,Rule 1 Active	<0 (No) 1 (Yes)>	= 1
210101003 =	IP Filter Set 1,Rule 1 Protocol		= 6
210101004 =	IP Filter Set 1,Rule 1 Dest IP address		= 0.0.0.0
210101005 =	IP Filter Set 1,Rule 1 Dest Subnet Mask		= 0
210101006 =	IP Filter Set 1,Rule 1 Dest Port		= 137
210101007 =	IP Filter Set 1,Rule 1 Dest Port Comp	<0 (none) 1 (equal) 2 (not equal) 3 (less) 4 (greater)>	= 1
210101008 =	IP Filter Set 1,Rule 1 Src IP address		= 0.0.0.0
210101009 =	IP Filter Set 1,Rule 1 Src Subnet Mask		= 0
210101010 =	IP Filter Set 1,Rule 1 Src Port		= 0
210101011 =	IP Filter Set 1,Rule 1 Src Port Comp	<0 (none) 1 (equal) 2 (not equal) 3 (less) 4 (greater)>	= 0
210101013 =	IP Filter Set 1,Rule 1 Act Match	<1 (check next) 2 (forward) 3 (drop)>	= 3
210101014 =	IP Filter Set 1,Rule 1 Act Not Match	<1 (check next) 2 (forward) 3 (drop)>	= 1
/ Menu 21.1.1.2 set #1, rule #2			
FIN	FN	PVA	INPUT
210102001 =	IP Filter Set 1,Rule 2 Type	<2 (TCP/IP)>	= 2
210102002 =	IP Filter Set 1,Rule 2 Active	<0 (No) 1 (Yes)>	= 1
210102003 =	IP Filter Set 1,Rule 2 Protocol		= 6
210102004 =	IP Filter Set 1,Rule 2 Dest IP address		= 0.0.0.0
210102005 =	IP Filter Set 1,Rule 2 Dest Subnet Mask		= 0
210102006 =	IP Filter Set 1,Rule 2 Dest Port		= 138
210102007 =	IP Filter Set 1,Rule 2 Dest Port Comp	<0 (none) 1 (equal) 2 (not equal) 3 (less) 4 (greater)>	= 1
210102008 =	IP Filter Set 1,Rule 2 Src IP address		= 0.0.0.0
210102009 =	IP Filter Set 1,Rule 2 Src Subnet Mask		= 0
210102010 =	IP Filter Set 1,Rule 2 Src Port		= 0
210102011 =	IP Filter Set 1,Rule 2 Src Port Comp	<0 (none) 1 (equal) 2 (not equal) 3 (less) 4 (greater)>	= 0

Table 60 Menu 21.1 Filter Set #1 (continued)

210102013 =	IP Filter Set 1, Rule 2 Act Match	<1 (check next) 2 (forward) 3 (drop)>	= 3
210102014 =	IP Filter Set 1, Rule 2 Act Not Match	<1 (check next) 2 (forward) 3 (drop)>	= 1

Table 61 Menu 21.1 Filter Set #2,

/ Menu 21.1 filter set #2,			
FIN	FN	PVA	INPUT
210200001 =	Filter Set 2, Nam	<Str>	= NetBIOS_WAN
/ Menu 21.1.2.1 Filter set #2, rule #1			
FIN	FN	PVA	INPUT
210201001 =	IP Filter Set 2, Rule 1 Type	<0 (none) 2 (TCP/IP)>	= 2
210201002 =	IP Filter Set 2, Rule 1 Active	<0 (No) 1 (Yes)>	= 1
210201003 =	IP Filter Set 2, Rule 1 Protocol		= 6
210201004 =	IP Filter Set 2, Rule 1 Dest IP address		= 0.0.0.0
210201005 =	IP Filter Set 2, Rule 1 Dest Subnet Mask		= 0
210201006 =	IP Filter Set 2, Rule 1 Dest Port		= 137
210201007 =	IP Filter Set 2, Rule 1 Dest Port Comp	<0 (none) 1 (equal) 2 (not equal) 3 (less) 4 (greater)>	= 1
210201008 =	IP Filter Set 2, Rule 1 Src IP address		= 0.0.0.0
210201009 =	IP Filter Set 2, Rule 1 Src Subnet Mask		= 0
210201010 =	IP Filter Set 2, Rule 1 Src Port		= 0
210201011 =	IP Filter Set 2, Rule 1 Src Port Comp	<0 (none) 1 (equal) 2 (not equal) 3 (less) 4 (greater)>	= 0
210201013 =	IP Filter Set 2, Rule 1 Act Match	<1 (check next) 2 (forward) 3 (drop)>	= 3
210201014 =	IP Filter Set 2, Rule 1 Act Not Match	<1 (check next) 2 (forward) 3 (drop)>	= 1
/ Menu 21.1.2.2 Filter set #2, rule #2			
FIN	FN	PVA	INPUT

Table 61 Menu 21.1 Filter Set #2, (continued)

210202001 =	IP Filter Set 2, Rule 2 Type	<0 (none) 2 (TCP/IP)>	= 2
210202002 =	IP Filter Set 2, Rule 2 Active	<0 (No) 1 (Yes)>	= 1
210202003 =	IP Filter Set 2, Rule 2 Protocol		= 6
210202004 =	IP Filter Set 2, Rule 2 Dest IP address		= 0.0.0.0
210202005 =	IP Filter Set 2, Rule 2 Dest Subnet Mask		= 0
210202006 =	IP Filter Set 2, Rule 2 Dest Port		= 138
210202007 =	IP Filter Set 2, Rule 2 Dest Port Comp	<0 (none) 1 (equal) 2 (not equal) 3 (less) 4 (greater)>	= 1
210202008 =	IP Filter Set 2, Rule 2 Src IP address		= 0.0.0.0
210202009 =	IP Filter Set 2, Rule 2 Src Subnet Mask		= 0
210202010 =	IP Filter Set 2, Rule 2 Src Port		= 0
210202011 =	IP Filter Set 2, Rule 2 Src Port Comp	<0 (none) 1 (equal) 2 (not equal) 3 (less) 4 (greater)>	= 0
210202013 =	IP Filter Set 2, Rule 2 Act Match	<1 (check next) 2 (forward) 3 (drop)>	= 3
210202014 =	IP Filter Set 2, Rule 2 Act Not Match	<1 (check next) 2 (forward) 3 (drop)>	= 1

Table 62 Menu 23 System Menus

*/ Menu 23.1 System Password Setup			
FIN	FN	PVA	INPUT
230000000 =	System Password		= 1234
*/ Menu 23.2 System security: radius server			
FIN	FN	PVA	INPUT
230200001 =	Authentication Server Configured	<0 (No) 1 (Yes)>	= 1
230200002 =	Authentication Server Active	<0 (No) 1 (Yes)>	= 1
230200003 =	Authentication Server IP Address		= 192.168.1.32
230200004 =	Authentication Server Port		= 1822

Table 62 Menu 23 System Menus (continued)

230200005 =	Authentication Server Shared Secret		= 111111111111 111 111111111111 1111
230200006 =	Accounting Server Configured	<0 (No) 1 (Yes)>	= 1
230200007 =	Accounting Server Active	<0 (No) 1 (Yes)>	= 1
230200008 =	Accounting Server IP Address		= 192.168.1.44
230200009 =	Accounting Server Port		= 1823
230200010 =	Accounting Server Shared Secret		= 1234
*/ Menu 23.4 System security: IEEE802.1x			
FIN	FN	PVA	INPUT
230400001 =	Wireless Port Control	<0 (Authentication Required) 1 (No Access Allowed) 2 (No Authentication Required)>	= 2
230400002 =	ReAuthentication Timer (in second)		= 555
230400003 =	Idle Timeout (in second)		= 999
230400004 =	Authentication Databases	<0 (Local User Database Only) 1 (RADIUS Only) 2 (Local, RADIUS) 3 (RADIUS, Local)>	= 1
230400005 =	Key Management Protocol	<0 (8021x) 1 (WPA) 2 (WPA2)>	= 0
230400006 =	Dynamic WEP Key Exchange	<0 (Disable) 1 (64-bit WEP) 2 (128-bit WEP)>	= 0
230400007 =	PSK =		=
230400008 =	WPA Mixed Mode	<0 (Disable) 1 (Enable)>	= 0
230400009 =	Data Privacy for Broadcast/Multicast packets	<0 (TKIP) 1 (WEP)>	= 0
230400010 =	WPA Broadcast/Multicast Key Update Timer		= 0

Table 63 Menu 24.11 Remote Management Control

/ Menu 24.11 Remote Management Control			
FIN	FN	PVA	INPUT
241100001 =	TELNET Server Port		= 23

Table 63 Menu 24.11 Remote Management Control (continued)

241100002 =	TELNET Server Access	<0 (all) 1 (none) 2 (Lan) 3 (Wan) >	= 0
241100003 =	TELNET Server Secured IP address		= 0.0.0.0
241100004 =	FTP Server Port		= 21
241100005 =	FTP Server Access	<0 (all) 1 (none) 2 (Lan) 3 (Wan) >	= 0
241100006 =	FTP Server Secured IP address		= 0.0.0.0
241100007 =	WEB Server Port		= 80
241100008 =	WEB Server Access	<0 (all) 1 (none) 2 (Lan) 3 (Wan) >	= 0
241100009 =	WEB Server Secured IP address		= 0.0.0.0

Command Examples

The following are example Internal SPTGEN screens associated with the ZyxEL Device's command interpreter commands.

Table 64 Command Examples

FIN	FN	PVA	INPUT
/ci command (for annex a): wan adsl opencmd			
990000001 =	ADSL OPMD	<0 (glite) 1 (t1.413) 2 (gdm) 3 (multimode) >	= 3
/ci command (for annex B): wan adsl opencmd			
990000001 =	ADSL OPMD	<0 (etsi) 1 (normal) 2 (gdm) 3 (multimode) >	= 3

APPENDIX C

Wall-mounting Instructions

Do the following to hang your ZyXEL Device on a wall.

Note: See the product specifications appendix for the size of screws to use and how far apart to place them.

- 1 Locate a high position on wall that is free of obstructions. Use a sturdy wall.
- 2 Drill two holes for the screws. Make sure the distance between the centers of the holes matches what is listed in the product specifications appendix.

Note: Be careful to avoid damaging pipes or cables located inside the wall when drilling holes for the screws.

- 3 Do not screw the screws all the way into the wall. Leave a small gap of about 0.5 cm between the heads of the screws and the wall.
- 4 Make sure the screws are snugly fastened to the wall. They need to hold the weight of the ZyXEL Device with the connection cables.
- 5 Align the holes on the back of the ZyXEL Device with the screws on the wall. Hang the ZyXEL Device on the screws.

Figure 95 Wall-mounting Example

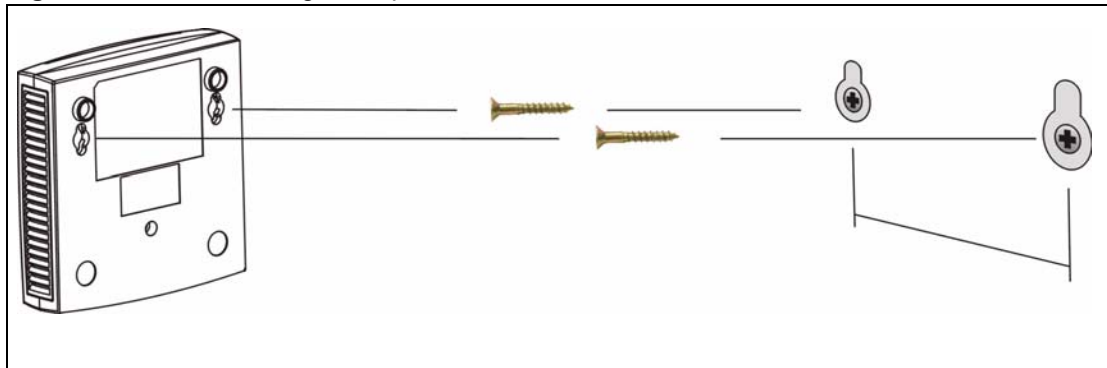

APPENDIX D

Setting up Your Computer's IP Address

All computers must have a 10M or 100M Ethernet adapter card and TCP/IP installed.

Windows 95/98/Me/NT/2000/XP, Macintosh OS 7 and later operating systems and all versions of UNIX/LINUX include the software components you need to install and use TCP/IP on your computer. Windows 3.1 requires the purchase of a third-party TCP/IP application package.

TCP/IP should already be installed on computers using Windows NT/2000/XP, Macintosh OS 7 and later operating systems.

After the appropriate TCP/IP components are installed, configure the TCP/IP settings in order to "communicate" with your network.

If you manually assign IP information instead of using dynamic assignment, make sure that your computers have IP addresses that place them in the same subnet as the ZyXEL Device's LAN port.

Windows 95/98/Me

Click **Start**, **Settings**, **Control Panel** and double-click the **Network** icon to open the **Network** window.

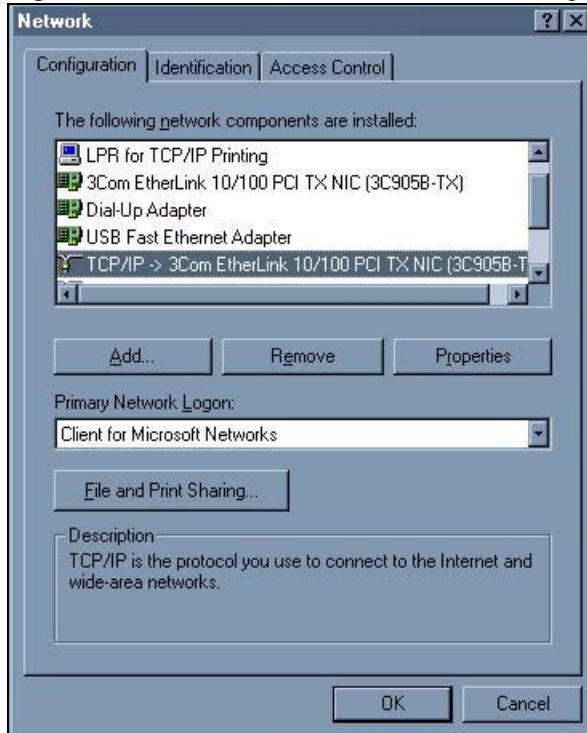
Figure 96 Windows 95/98/Me: Network: Configuration

Installing Components

The **Network** window **Configuration** tab displays a list of installed components. You need a network adapter, the TCP/IP protocol and Client for Microsoft Networks.

If you need the adapter:

- 1 In the **Network** window, click **Add**.
- 2 Select **Adapter** and then click **Add**.
- 3 Select the manufacturer and model of your network adapter and then click **OK**.

If you need TCP/IP:

- 1 In the **Network** window, click **Add**.
- 2 Select **Protocol** and then click **Add**.
- 3 Select **Microsoft** from the list of **manufacturers**.
- 4 Select **TCP/IP** from the list of network protocols and then click **OK**.

If you need Client for Microsoft Networks:

- 1 Click **Add**.
- 2 Select **Client** and then click **Add**.
- 3 Select **Microsoft** from the list of manufacturers.

4 Select **Client for Microsoft Networks** from the list of network clients and then click **OK**.

5 Restart your computer so the changes you made take effect.

Configuring

1 In the **Network** window **Configuration** tab, select your network adapter's TCP/IP entry and click **Properties**

2 Click the **IP Address** tab.

- If your IP address is dynamic, select **Obtain an IP address automatically**.
- If you have a static IP address, select **Specify an IP address** and type your information into the **IP Address** and **Subnet Mask** fields.

Figure 97 Windows 95/98/Me: TCP/IP Properties: IP Address

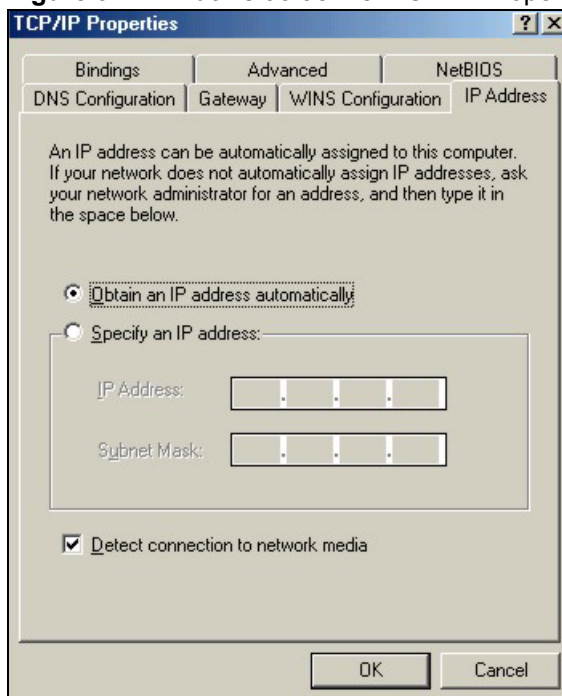

3 Click the **DNS Configuration** tab.

- If you do not know your DNS information, select **Disable DNS**.
- If you know your DNS information, select **Enable DNS** and type the information in the fields below (you may not need to fill them all in).

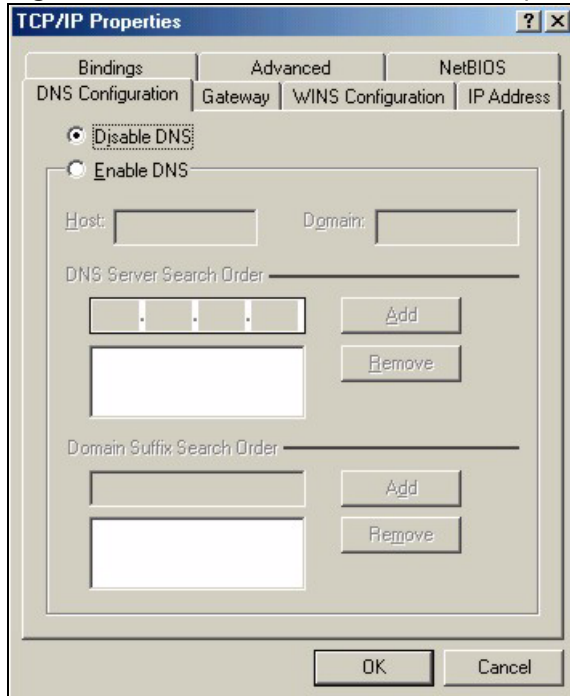
Figure 98 Windows 95/98/Me: TCP/IP Properties: DNS Configuration**4** Click the **Gateway** tab.

- If you do not know your gateway's IP address, remove previously installed gateways.
- If you have a gateway IP address, type it in the **New gateway** field and click **Add**.

5 Click **OK** to save and close the **TCP/IP Properties** window.**6** Click **OK** to close the **Network** window. Insert the Windows CD if prompted.**7** Turn on your ZyXEL Device and restart your computer when prompted.

Verifying Settings

1 Click **Start** and then **Run**.**2** In the **Run** window, type "winipcfg" and then click **OK** to open the **IP Configuration** window.**3** Select your network adapter. You should see your computer's IP address, subnet mask and default gateway.

Windows 2000/NT/XP

The following example figures use the default Windows XP GUI theme.

1 Click **start** (**Start** in Windows 2000/NT), **Settings**, **Control Panel**.

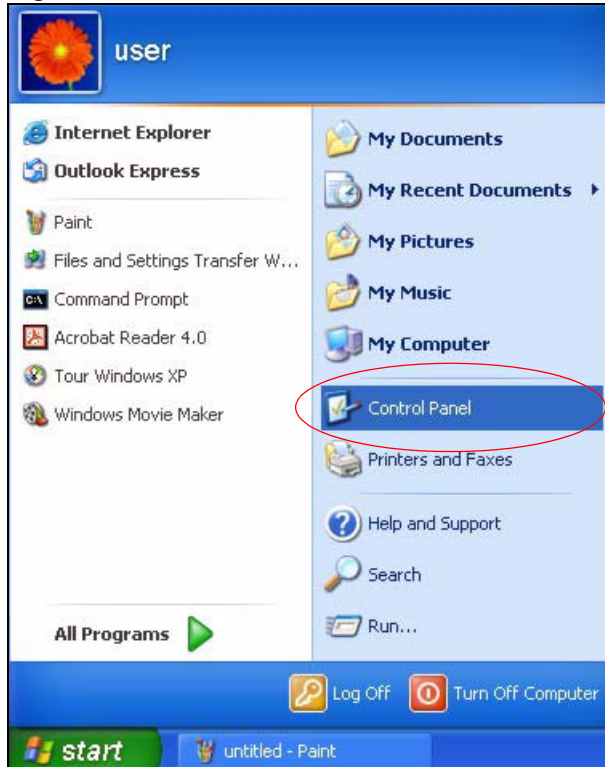
Figure 99 Windows XP: Start Menu

2 In the **Control Panel**, double-click **Network Connections** (**Network and Dial-up Connections** in Windows 2000/NT).

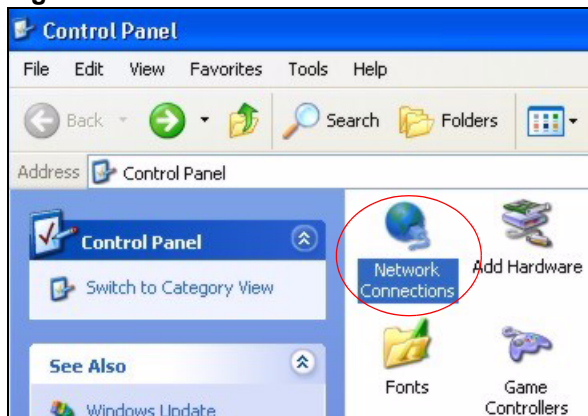
Figure 100 Windows XP: Control Panel

3 Right-click **Local Area Connection** and then click **Properties**.

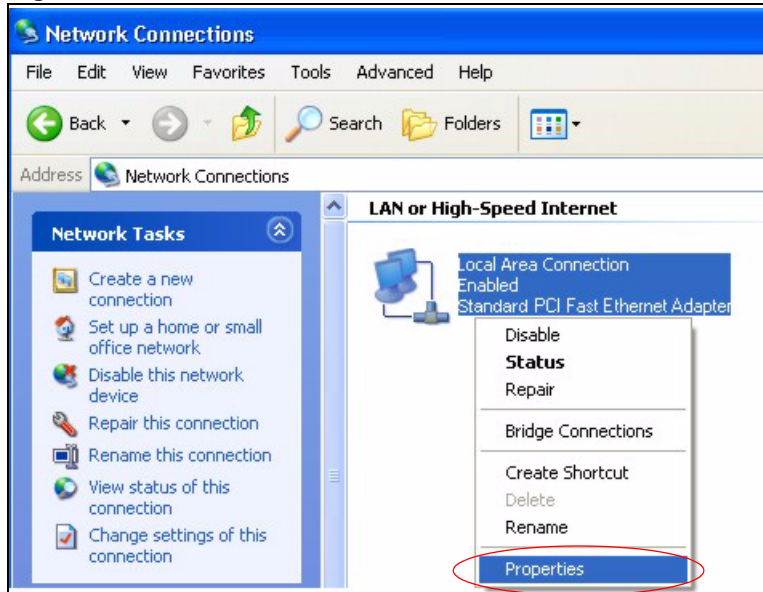
Figure 101 Windows XP: Control Panel: Network Connections: Properties

4 Select **Internet Protocol (TCP/IP)** (under the **General** tab in Win XP) and then click **Properties**.

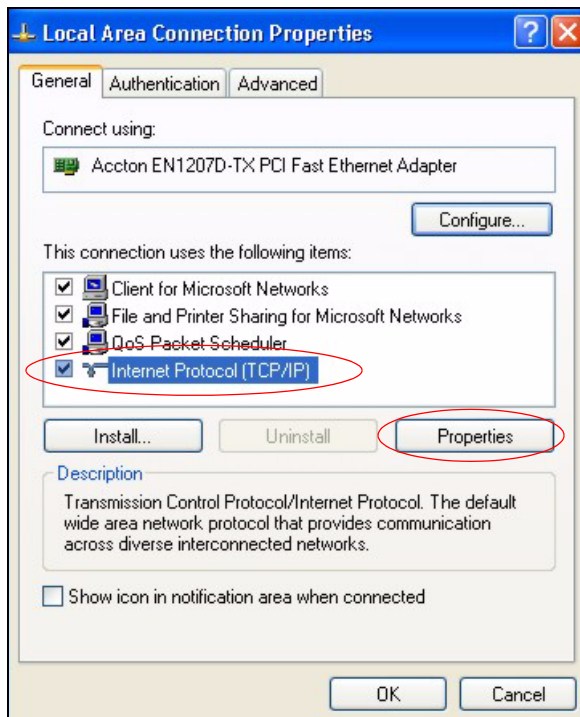
Figure 102 Windows XP: Local Area Connection Properties

5 The **Internet Protocol TCP/IP Properties** window opens (the **General** tab in Windows XP).

- If you have a dynamic IP address click **Obtain an IP address automatically**.
- If you have a static IP address click **Use the following IP Address** and fill in the **IP address**, **Subnet mask**, and **Default gateway** fields.
- Click **Advanced**.

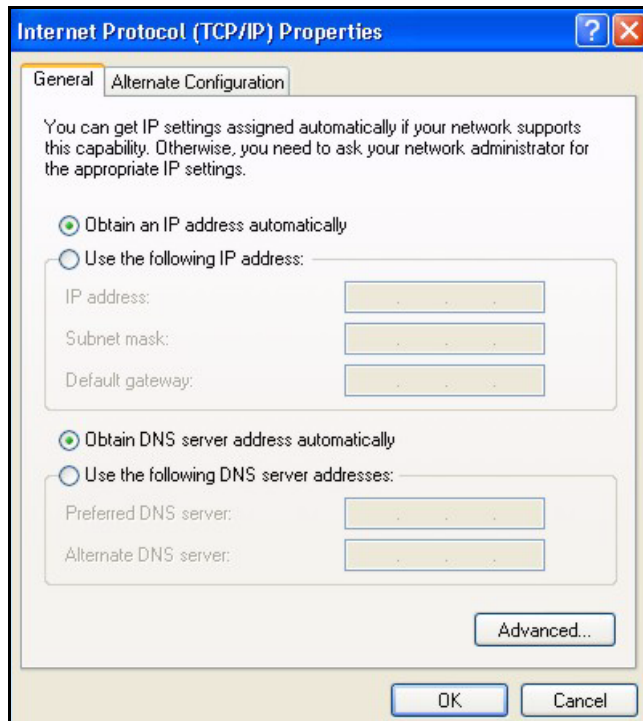
Figure 103 Windows XP: Internet Protocol (TCP/IP) Properties

- 6** If you do not know your gateway's IP address, remove any previously installed gateways in the **IP Settings** tab and click **OK**.

Do one or more of the following if you want to configure additional IP addresses:

- In the **IP Settings** tab, in IP addresses, click **Add**.
- In **TCP/IP Address**, type an IP address in **IP address** and a subnet mask in **Subnet mask**, and then click **Add**.
- Repeat the above two steps for each IP address you want to add.
- Configure additional default gateways in the **IP Settings** tab by clicking **Add** in **Default gateways**.
- In **TCP/IP Gateway Address**, type the IP address of the default gateway in **Gateway**. To manually configure a default metric (the number of transmission hops), clear the **Automatic metric** check box and type a metric in **Metric**.
- Click **Add**.
- Repeat the previous three steps for each default gateway you want to add.
- Click **OK** when finished.

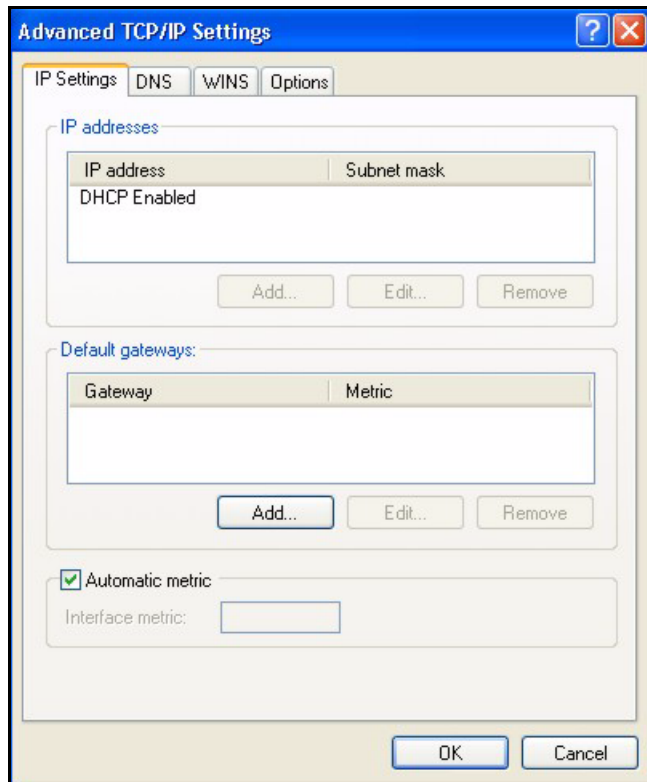
Figure 104 Windows XP: Advanced TCP/IP Properties

7 In the **Internet Protocol TCP/IP Properties** window (the **General** tab in Windows XP):

- Click **Obtain DNS server address automatically** if you do not know your DNS server IP address(es).
- If you know your DNS server IP address(es), click **Use the following DNS server addresses**, and type them in the **Preferred DNS server** and **Alternate DNS server** fields.

If you have previously configured DNS servers, click **Advanced** and then the **DNS** tab to order them.

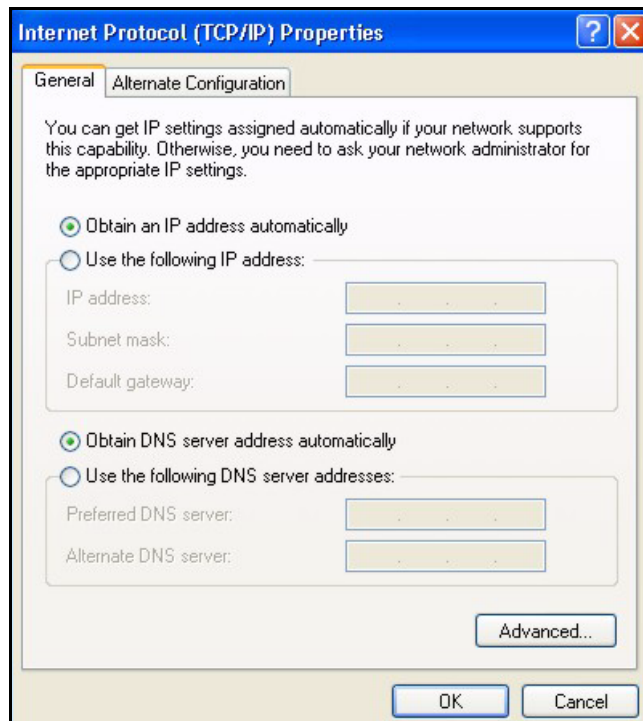
Figure 105 Windows XP: Internet Protocol (TCP/IP) Properties

- 8** Click **OK** to close the **Internet Protocol (TCP/IP) Properties** window.
- 9** Click **Close (OK in Windows 2000/NT)** to close the **Local Area Connection Properties** window.
- 10** Close the **Network Connections** window (**Network and Dial-up Connections** in Windows 2000/NT).
- 11** Turn on your ZyXEL Device and restart your computer (if prompted).

Verifying Settings

- 1** Click **Start, All Programs, Accessories** and then **Command Prompt**.
- 2** In the **Command Prompt** window, type "ipconfig" and then press [ENTER]. You can also open **Network Connections**, right-click a network connection, click **Status** and then click the **Support** tab.

Macintosh OS 8/9

- 1** Click the **Apple** menu, **Control Panel** and double-click **TCP/IP** to open the **TCP/IP Control Panel**.

Figure 106 Macintosh OS 8/9: Apple Menu

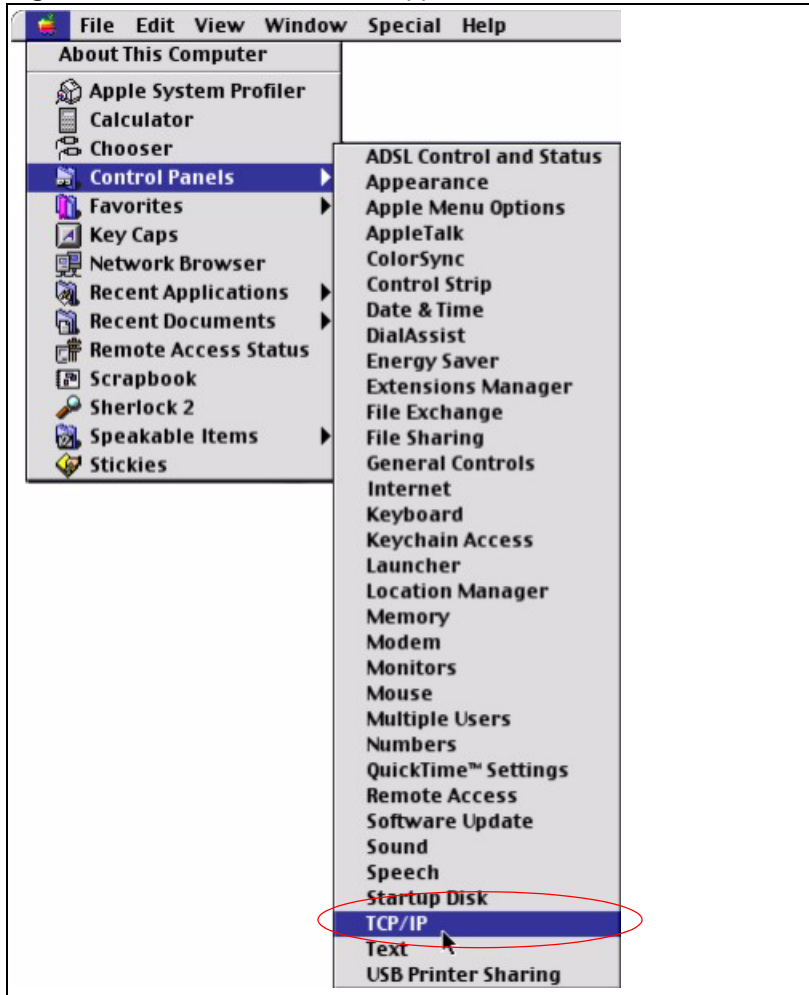

2 Select **Ethernet built-in** from the **Connect via** list.

Figure 107 Macintosh OS 8/9: TCP/IP

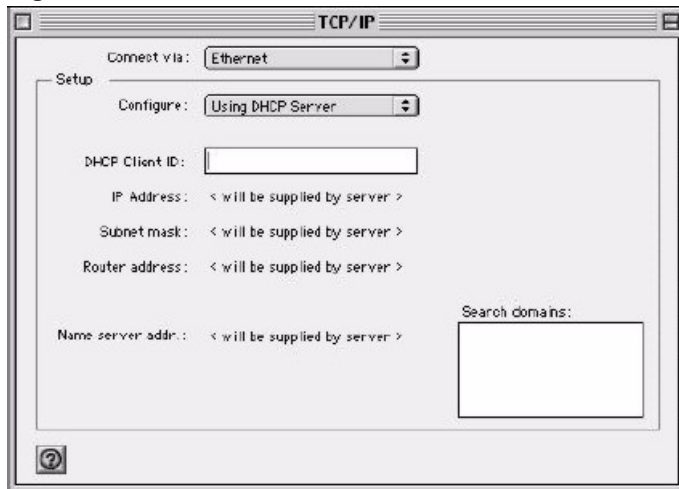

3 For dynamically assigned settings, select **Using DHCP Server** from the **Configure:** list.

4 For statically assigned settings, do the following:

- From the **Configure** box, select **Manually**.
- Type your IP address in the **IP Address** box.
- Type your subnet mask in the **Subnet mask** box.
- Type the IP address of your ZyXEL Device in the **Router address** box.

5 Close the **TCP/IP Control Panel**.

6 Click **Save** if prompted, to save changes to your configuration.

7 Turn on your ZyXEL Device and restart your computer (if prompted).

Verifying Settings

Check your TCP/IP properties in the **TCP/IP Control Panel** window.

Macintosh OS X

1 Click the **Apple** menu, and click **System Preferences** to open the **System Preferences** window.

Figure 108 Macintosh OS X: Apple Menu

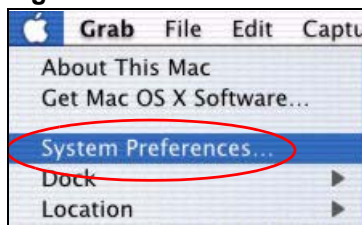

2 Click **Network** in the icon bar.

- Select **Automatic** from the **Location** list.
- Select **Built-in Ethernet** from the **Show** list.
- Click the **TCP/IP** tab.

3 For dynamically assigned settings, select **Using DHCP** from the **Configure** list.

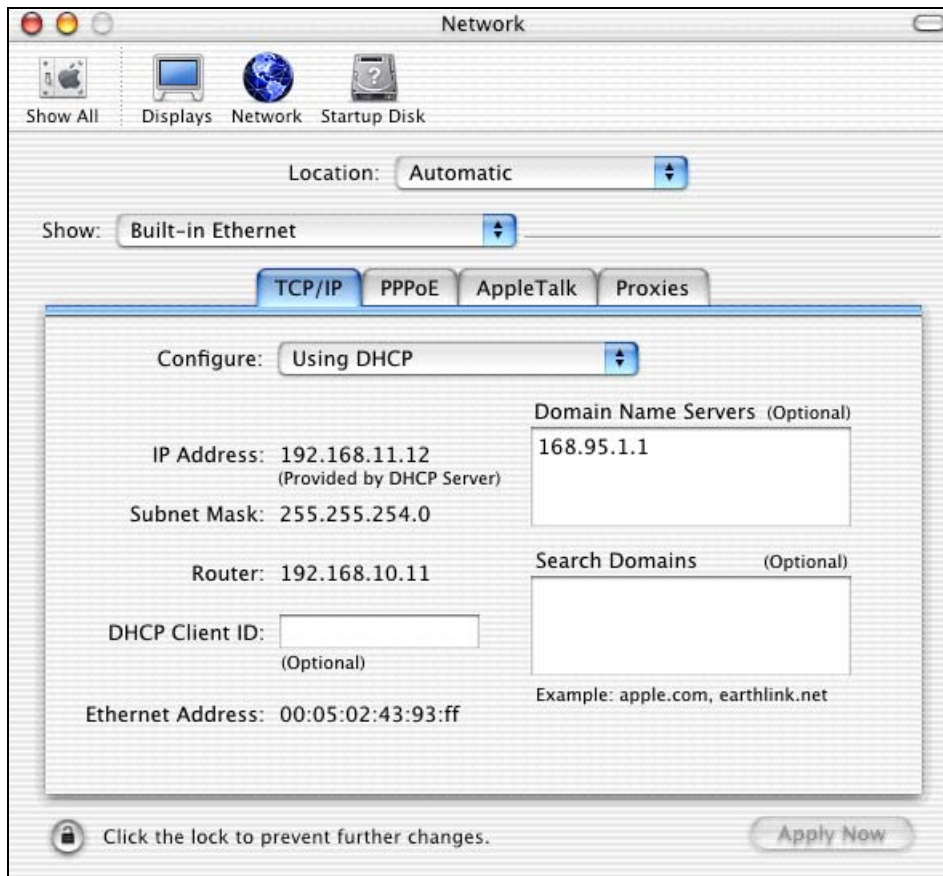
Figure 109 Macintosh OS X: Network

4 For statically assigned settings, do the following:

- From the **Configure** box, select **Manually**.
- Type your IP address in the **IP Address** box.
- Type your subnet mask in the **Subnet mask** box.
- Type the IP address of your ZyXEL Device in the **Router address** box.

5 Click **Apply Now** and close the window.

6 Turn on your ZyXEL Device and restart your computer (if prompted).

Verifying Settings

Check your TCP/IP properties in the **Network** window.

Linux

This section shows you how to configure your computer's TCP/IP settings in Red Hat Linux 9.0. Procedure, screens and file location may vary depending on your Linux distribution and release version.

Note: Make sure you are logged in as the root administrator.

Using the K Desktop Environment (KDE)

Follow the steps below to configure your computer IP address using the KDE.

- 1 Click the Red Hat button (located on the bottom left corner), select **System Setting** and click **Network**.

Figure 110 Red Hat 9.0: KDE: Network Configuration: Devices

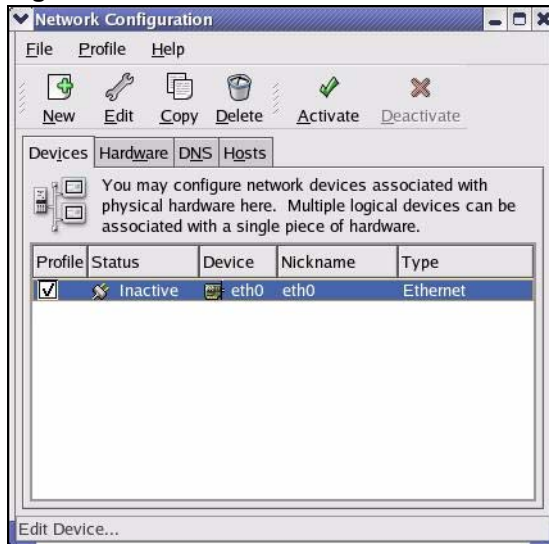

- 2 Double-click on the profile of the network card you wish to configure. The **Ethernet Device General** screen displays as shown.

Figure 111 Red Hat 9.0: KDE: Ethernet Device: General

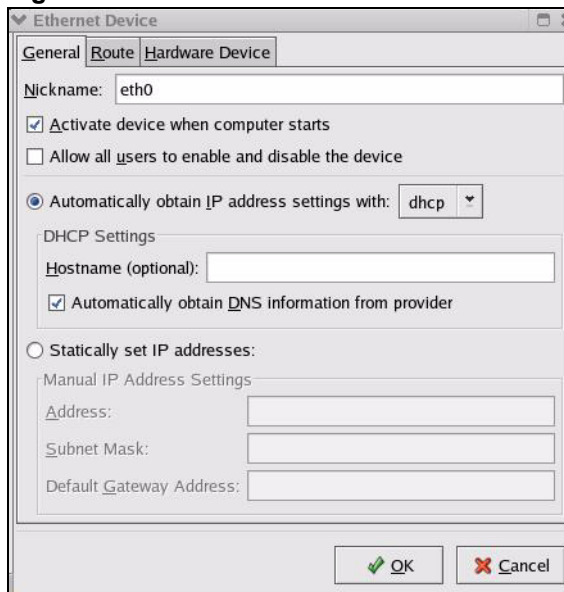

- If you have a dynamic IP address click **Automatically obtain IP address settings with** and select **dhcp** from the drop down list.
- If you have a static IP address click **Statically set IP Addresses** and fill in the **Address**, **Subnet mask**, and **Default Gateway Address** fields.

- 3 Click **OK** to save the changes and close the **Ethernet Device General** screen.
- 4 If you know your DNS server IP address(es), click the **DNS** tab in the **Network Configuration** screen. Enter the DNS server information in the fields provided.

Figure 112 Red Hat 9.0: KDE: Network Configuration: DNS

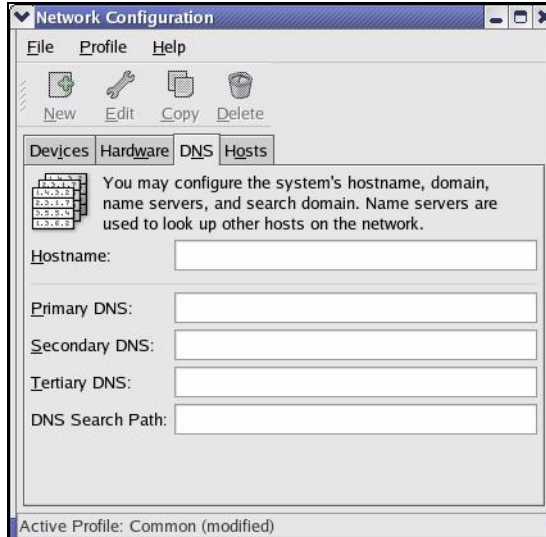

- 5 Click the **Devices** tab.
- 6 Click the **Activate** button to apply the changes. The following screen displays. Click **Yes** to save the changes in all screens.

Figure 113 Red Hat 9.0: KDE: Network Configuration: Activate



- 7 After the network card restart process is complete, make sure the **Status** is **Active** in the **Network Configuration** screen.

Using Configuration Files

Follow the steps below to edit the network configuration files and set your computer IP address.

- 1 Assuming that you have only one network card on the computer, locate the `ifconfig-eth0` configuration file (where `eth0` is the name of the Ethernet card). Open the configuration file with any plain text editor.
 - If you have a dynamic IP address, enter `dhcp` in the `BOOTPROTO=` field. The following figure shows an example.

Figure 114 Red Hat 9.0: Dynamic IP Address Setting in ifconfig-eth0

```
DEVICE=eth0
ONBOOT=yes
BOOTPROTO=dhcp
USERCTL=no
PEERDNS=yes
TYPE=Ethernet
```

- If you have a static IP address, enter **static** in the `BOOTPROTO=` field. Type `IPADDR=` followed by the IP address (in dotted decimal notation) and type `NETMASK=` followed by the subnet mask. The following example shows an example where the static IP address is 192.168.1.10 and the subnet mask is 255.255.255.0.

Figure 115 Red Hat 9.0: Static IP Address Setting in ifconfig-eth0

```
DEVICE=eth0
ONBOOT=yes
BOOTPROTO=static
IPADDR=192.168.1.10
NETMASK=255.255.255.0
USERCTL=no
PEERDNS=yes
TYPE=Ethernet
```

- 2 If you know your DNS server IP address(es), enter the DNS server information in the `resolv.conf` file in the `/etc` directory. The following figure shows an example where two DNS server IP addresses are specified.

Figure 116 Red Hat 9.0: DNS Settings in resolv.conf

```
nameserver 172.23.5.1
nameserver 172.23.5.2
```

- 3 After you edit and save the configuration files, you must restart the network card. Enter `./network restart` in the `/etc/rc.d/init.d` directory. The following figure shows an example.

Figure 117 Red Hat 9.0: Restart Ethernet Card

```
[root@localhost init.d]# network restart

Shutting down interface eth0:                [OK]
Shutting down loopback interface:            [OK]
Setting network parameters:                  [OK]
Bringing up loopback interface:              [OK]
Bringing up interface eth0:                  [OK]
```

Verifying Settings

Enter `ifconfig` in a terminal screen to check your TCP/IP properties.

Figure 118 Red Hat 9.0: Checking TCP/IP Properties

```
[root@localhost]# ifconfig
eth0      Link encap:Ethernet  HWaddr 00:50:BA:72:5B:44
          inet addr:172.23.19.129  Bcast:172.23.19.255  Mask:255.255.255.0
          UP BROADCAST RUNNING MULTICAST  MTU:1500  Metric:1
          RX packets:717 errors:0 dropped:0 overruns:0 frame:0
          TX packets:13 errors:0 dropped:0 overruns:0 carrier:0
          collisions:0 txqueuelen:100
          RX bytes:730412 (713.2 Kb)  TX bytes:1570 (1.5 Kb)
          Interrupt:10 Base address:0x1000
[root@localhost]#
```

APPENDIX E

IP Addresses and Subnetting

This appendix introduces IP addresses, IP address classes and subnet masks. You use subnet masks to subdivide a network into smaller logical networks.

Introduction to IP Addresses

An IP address has two parts: the network number and the host ID. Routers use the network number to send packets to the correct network, while the host ID identifies a single device on the network.

An IP address is made up of four octets, written in dotted decimal notation, for example, 192.168.1.1. (An octet is an 8-digit binary number. Therefore, each octet has a possible range of 00000000 to 11111111 in binary, or 0 to 255 in decimal.)

There are several classes of IP addresses. The first network number (192 in the above example) defines the class of IP address. These are defined as follows:

- Class A: 0 to 127
- Class B: 128 to 191
- Class C: 192 to 223
- Class D: 224 to 239
- Class E: 240 to 255

IP Address Classes and Hosts

The class of an IP address determines the number of hosts you can have on your network.

- In a class A address the first octet is the network number, and the remaining three octets are the host ID.
- In a class B address the first two octets make up the network number, and the two remaining octets make up the host ID.
- In a class C address the first three octets make up the network number, and the last octet is the host ID.

The following table shows the network number and host ID arrangement for classes A, B and C.

Table 65 Classes of IP Addresses

IP ADDRESS	OCTET 1	OCTET 2	OCTET 3	OCTET 4
Class A	Network number	Host ID	Host ID	Host ID
Class B	Network number	Network number	Host ID	Host ID
Class C	Network number	Network number	Network number	Host ID

An IP address with host IDs of all zeros is the IP address of the network (192.168.1.0 for example). An IP address with host IDs of all ones is the broadcast address for that network (192.168.1.255 for example). Therefore, to determine the total number of hosts allowed in a network, deduct two as shown next:

- A class C address (1 host octet: 8 host bits) can have $2^8 - 2$, or 254 hosts.
- A class B address (2 host octets: 16 host bits) can have $2^{16} - 2$, or 65534 hosts.

A class A address (3 host octets: 24 host bits) can have $2^{24} - 2$ hosts, or approximately 16 million hosts.

IP Address Classes and Network ID

The value of the first octet of an IP address determines the class of an address.

- Class A addresses have a **0** in the leftmost bit.
- Class B addresses have a **1** in the leftmost bit and a **0** in the next leftmost bit.
- Class C addresses start with **1 1 0** in the first three leftmost bits.
- Class D addresses begin with **1 1 1 0**. Class D addresses are used for multicasting, which is used to send information to groups of computers.
- There is also a class E. It is reserved for future use.

The following table shows the allowed ranges for the first octet of each class. This range determines the number of subnets you can have in a network.

Table 66 Allowed IP Address Range By Class

CLASS	ALLOWED RANGE OF FIRST OCTET (BINARY)	ALLOWED RANGE OF FIRST OCTET (DECIMAL)
Class A	00000000 to 01111111	0 to 127
Class B	10000000 to 10111111	128 to 191
Class C	11000000 to 11011111	192 to 223
Class D	11100000 to 11101111	224 to 239
Class E (reserved)	11110000 to 11111111	240 to 255

Subnet Masks

A subnet mask is used to determine which bits are part of the network number, and which bits are part of the host ID (using a logical AND operation).

A subnet mask has 32 bits. If a bit in the subnet mask is a “1” then the corresponding bit in the IP address is part of the network number. If a bit in the subnet mask is “0” then the corresponding bit in the IP address is part of the host ID.

Subnet masks are expressed in dotted decimal notation just like IP addresses. The “natural” masks for class A, B and C IP addresses are as follows.

Table 67 “Natural” Masks

CLASS	NATURAL MASK
A	255.0.0.0
B	255.255.0.0
C	255.255.255.0

Subnetting

With subnetting, the class arrangement of an IP address is ignored. For example, a class C address no longer has to have 24 bits of network number and 8 bits of host ID. With subnetting, some of the host ID bits are converted into network number bits.

By convention, subnet masks always consist of a continuous sequence of ones beginning from the leftmost bit of the mask, followed by a continuous sequence of zeros, for a total number of 32 bits.

Since the mask is always a continuous number of ones beginning from the left, followed by a continuous number of zeros for the remainder of the 32 bit mask, you can simply specify the number of ones instead of writing the value of each octet. This is usually specified by writing a “/” followed by the number of bits in the mask after the address.

For example, 192.1.1.0 /25 is equivalent to saying 192.1.1.0 with mask 255.255.255.128.

The following table shows all possible subnet masks for a class “C” address using both notations.

Table 68 Alternative Subnet Mask Notation

SUBNET MASK	SUBNET MASK “1” BITS	LAST OCTET BIT VALUE	DECIMAL
255.255.255.0	/24	0000 0000	0
255.255.255.128	/25	1000 0000	128
255.255.255.192	/26	1100 0000	192
255.255.255.224	/27	1110 0000	224
255.255.255.240	/28	1111 0000	240
255.255.255.248	/29	1111 1000	248
255.255.255.252	/30	1111 1100	252

The first mask shown is the class “C” natural mask. Normally if no mask is specified it is understood that the natural mask is being used.

Example: Two Subnets

As an example, you have a class “C” address 192.168.1.0 with subnet mask of 255.255.255.0.

Table 69 Two Subnets Example

IP/SUBNET MASK	NETWORK NUMBER	HOST ID
IP Address	192.168.1.	0
IP Address (Binary)	11000000.10101000.00000001.	00000000
Subnet Mask	255.255.255.	0
Subnet Mask (Binary)	11111111.11111111.11111111.	00000000

The first three octets of the address make up the network number (class “C”).

To make two networks, divide the network 192.168.1.0 into two separate subnets by converting one of the host ID bits of the IP address to a network number bit. The “borrowed” host ID bit can be either “0” or “1” thus giving two subnets; 192.168.1.0 with mask 255.255.255.128 and 192.168.1.128 with mask 255.255.255.128.

Note: In the following charts, shaded/bolded last octet bit values indicate host ID bits “borrowed” to make network ID bits. The number of “borrowed” host ID bits determines the number of subnets you can have. The remaining number of host ID bits (after “borrowing”) determines the number of hosts you can have on each subnet.

Table 70 Subnet 1

IP/SUBNET MASK	NETWORK NUMBER	LAST OCTET BIT VALUE
IP Address	192.168.1.	0
IP Address (Binary)	11000000.10101000.00000001.	00000000
Subnet Mask	255.255.255.	128
Subnet Mask (Binary)	11111111.11111111.11111111.	10000000
Subnet Address: 192.168.1.0	Lowest Host ID: 192.168.1.1	
Broadcast Address: 192.168.1.127	Highest Host ID: 192.168.1.126	

Table 71 Subnet 2

IP/SUBNET MASK	NETWORK NUMBER	LAST OCTET BIT VALUE
IP Address	192.168.1.	128
IP Address (Binary)	11000000.10101000.00000001.	10000000
Subnet Mask	255.255.255.	128
Subnet Mask (Binary)	11111111.11111111.11111111.	10000000

Table 71 Subnet 2 (continued)

IP/SUBNET MASK	NETWORK NUMBER	LAST OCTET BIT VALUE
Subnet Address: 192.168.1.128	Lowest Host ID: 192.168.1.129	
Broadcast Address: 192.168.1.255	Highest Host ID: 192.168.1.254	

Host IDs of all zeros represent the subnet itself and host IDs of all ones are the broadcast address for that subnet, so the actual number of hosts available on each subnet in the example above is $2^7 - 2$ or 126 hosts for each subnet.

192.168.1.0 with mask 255.255.255.128 is the subnet itself, and 192.168.1.127 with mask 255.255.255.128 is the directed broadcast address for the first subnet. Therefore, the lowest IP address that can be assigned to an actual host for the first subnet is 192.168.1.1 and the highest is 192.168.1.126. Similarly the host ID range for the second subnet is 192.168.1.129 to 192.168.1.254.

Example: Four Subnets

The above example illustrated using a 25-bit subnet mask to divide a class “C” address space into two subnets. Similarly to divide a class “C” address into four subnets, you need to “borrow” two host ID bits to give four possible combinations (00, 01, 10 and 11). The subnet mask is 26 bits (11111111.11111111.11111111.11000000) or 255.255.255.192. Each subnet contains 6 host ID bits, giving $2^6 - 2$ or 62 hosts for each subnet (all zeroes is the subnet itself, all ones is the broadcast address on the subnet).

Table 72 Subnet 1

IP/SUBNET MASK	NETWORK NUMBER	LAST OCTET BIT VALUE
IP Address	192.168.1.	0
IP Address (Binary)	11000000.10101000.00000001.	00000000
Subnet Mask (Binary)	11111111.11111111.11111111.	11000000
Subnet Address: 192.168.1.0	Lowest Host ID: 192.168.1.1	
Broadcast Address: 192.168.1.63	Highest Host ID: 192.168.1.62	

Table 73 Subnet 2

IP/SUBNET MASK	NETWORK NUMBER	LAST OCTET BIT VALUE
IP Address	192.168.1.	64
IP Address (Binary)	11000000.10101000.00000001.	01000000
Subnet Mask (Binary)	11111111.11111111.11111111.	11000000
Subnet Address: 192.168.1.64	Lowest Host ID: 192.168.1.65	
Broadcast Address: 192.168.1.127	Highest Host ID: 192.168.1.126	

Table 74 Subnet 3

IP/SUBNET MASK	NETWORK NUMBER	LAST OCTET BIT VALUE
IP Address	192.168.1.	128
IP Address (Binary)	11000000.10101000.00000001.	10000000
Subnet Mask (Binary)	11111111.11111111.11111111.	11000000
Subnet Address: 192.168.1.128	Lowest Host ID: 192.168.1.129	
Broadcast Address: 192.168.1.191	Highest Host ID: 192.168.1.190	

Table 75 Subnet 4

IP/SUBNET MASK	NETWORK NUMBER	LAST OCTET BIT VALUE
IP Address	192.168.1.	192
IP Address (Binary)	11000000.10101000.00000001.	11000000
Subnet Mask (Binary)	11111111.11111111.11111111.	11000000
Subnet Address: 192.168.1.192	Lowest Host ID: 192.168.1.193	
Broadcast Address: 192.168.1.255	Highest Host ID: 192.168.1.254	

Example Eight Subnets

Similarly use a 27-bit mask to create eight subnets (000, 001, 010, 011, 100, 101, 110 and 111).

The following table shows class C IP address last octet values for each subnet.

Table 76 Eight Subnets

SUBNET	SUBNET ADDRESS	FIRST ADDRESS	LAST ADDRESS	BROADCAST ADDRESS
1	0	1	30	31
2	32	33	62	63
3	64	65	94	95
4	96	97	126	127
5	128	129	158	159
6	160	161	190	191
7	192	193	222	223
8	224	225	254	255

The following table is a summary for class “C” subnet planning.

Table 77 Class C Subnet Planning

NO. “BORROWED” HOST BITS	SUBNET MASK	NO. SUBNETS	NO. HOSTS PER SUBNET
1	255.255.255.128 (/25)	2	126
2	255.255.255.192 (/26)	4	62
3	255.255.255.224 (/27)	8	30
4	255.255.255.240 (/28)	16	14
5	255.255.255.248 (/29)	32	6
6	255.255.255.252 (/30)	64	2
7	255.255.255.254 (/31)	128	1

Subnetting With Class A and Class B Networks.

For class “A” and class “B” addresses the subnet mask also determines which bits are part of the network number and which are part of the host ID.

A class “B” address has two host ID octets available for subnetting and a class “A” address has three host ID octets (see [Table 65 on page 1](#)) available for subnetting.

The following table is a summary for class “B” subnet planning.

Table 78 Class B Subnet Planning

NO. “BORROWED” HOST BITS	SUBNET MASK	NO. SUBNETS	NO. HOSTS PER SUBNET
1	255.255.128.0 (/17)	2	32766
2	255.255.192.0 (/18)	4	16382
3	255.255.224.0 (/19)	8	8190
4	255.255.240.0 (/20)	16	4094
5	255.255.248.0 (/21)	32	2046
6	255.255.252.0 (/22)	64	1022
7	255.255.254.0 (/23)	128	510
8	255.255.255.0 (/24)	256	254
9	255.255.255.128 (/25)	512	126
10	255.255.255.192 (/26)	1024	62
11	255.255.255.224 (/27)	2048	30
12	255.255.255.240 (/28)	4096	14
13	255.255.255.248 (/29)	8192	6
14	255.255.255.252 (/30)	16384	2
15	255.255.255.254 (/31)	32768	1

APPENDIX F

Command Interpreter

The following describes how to use the command interpreter. You can telnet to access the CLI (Command Line Interface) on the ZyXEL Device. See the included disk or zyxel.com for more detailed information on these commands.

Note: Use of undocumented commands or misconfiguration can damage the unit and possibly render it unusable.

Accessing the CLI

Use the following steps to telnet into your ZyXEL Device.

- 1 Connect your computer to the **ETHERNET** port on the ZyXEL Device.
- 2 Make sure your computer IP address and the ZyXEL Device IP address are on the same subnet. In Windows, click **Start** (usually in the bottom left corner), **Run** and then type `telnet 192.168.1.1` (the default ZyXEL Device IP address) and click **OK**.
- 3 A login screen displays. Enter the default admin password "1234".

Command Syntax

- The command keywords are in `courier new` font.
- Enter the command keywords exactly as shown, do not abbreviate.
- The required fields in a command are enclosed in angle brackets `<>`.
- The optional fields in a command are enclosed in square brackets `[]`.
- The `|` symbol means or.

For example,

```
sys filter netbios config <type> <on|off>
```

means that you must specify the type of netbios filter and whether to turn it on or off.

Command Usage

A list of valid commands can be found by typing `help` or `?` at the command prompt. Always type the full command. Type `exit` to log out of the CLI when finished.

APPENDIX G

NetBIOS Filter Commands

The following describes the NetBIOS packet filter commands.

Introduction

NetBIOS (Network Basic Input/Output System) are TCP or UDP broadcast packets that enable a computer to connect to and communicate with a LAN.

For some dial-up services such as PPPoE or PPTP, NetBIOS packets cause unwanted calls.

You can configure NetBIOS filters to do the following:

- Allow or disallow the sending of NetBIOS packets from the LAN to the WAN and from the WAN to the LAN.
- Allow or disallow the sending of NetBIOS packets through VPN connections.
- Allow or disallow NetBIOS packets to initiate calls.

Display NetBIOS Filter Settings

Syntax: `sys filter netbios disp`

This command gives a read-only list of the current NetBIOS filter modes for The ZyXEL Device.

NetBIOS Display Filter Settings Command Example

```
===== NetBIOS Filter Status =====  
Between LAN and WAN: Block  
IPSec Packets: Forward  
Trigger Dial: Disabled
```

The filter types and their default settings are as follows.

Table 79 NetBIOS Filter Default Settings

NAME	DESCRIPTION	EXAMPLE
Between LAN and WAN	This field displays whether NetBIOS packets are blocked or forwarded between the LAN and the WAN.	Block
IPSec Packets	This field displays whether NetBIOS packets sent through a VPN connection are blocked or forwarded.	Forward
Trigger dial	This field displays whether NetBIOS packets are allowed to initiate calls. Disabled means that NetBIOS packets are blocked from initiating calls.	Disabled

NetBIOS Filter Configuration

Syntax: `sys filter netbios config <type> <on|off>`

where

`<type>` = Identify which NetBIOS filter (numbered 0-3) to configure.
0 = Between LAN and WAN
3 = IPSec packet pass through
4 = Trigger Dial

`<on|off>` = For type 0 and 1, use on to enable the filter and block NetBIOS packets. Use off to disable the filter and forward NetBIOS packets.
For type 3, use on to block NetBIOS packets from being sent through a VPN connection. Use off to allow NetBIOS packets to be sent through a VPN connection.
For type 4, use on to allow NetBIOS packets to initiate dial backup calls. Use off to block NetBIOS packets from initiating dial backup calls.

Example commands

```
sys filter netbios config 0 on    This command blocks LAN to WAN and WAN to LAN NetBIOS packets.
```

```
sys filter netbios config 3 on    This command blocks IPSec NetBIOS packets.
```

```
sys filter netbios config 4 off   This command stops NetBIOS commands from initiating calls.
```

APPENDIX H

Splitters and Microfilters

This appendix tells you how to install a POTS splitter or a telephone microfilter.

Connecting a POTS Splitter

When you use the Full Rate (G.dmt) ADSL standard, you can use a POTS (Plain Old Telephone Service) splitter to separate the telephone and ADSL signals. This allows simultaneous Internet access and telephone service on the same line. A splitter also eliminates the destructive interference conditions caused by telephone sets.

Install the POTS splitter at the point where the telephone line enters your residence, as shown in the following figure.

Figure 119 Connecting a POTS Splitter

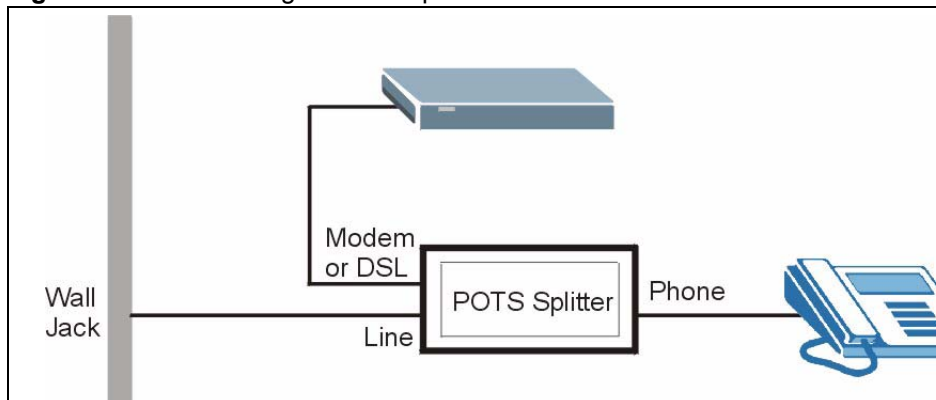

- 1 Connect the side labeled “Phone” or “TEL” to your telephone.
- 2 Connect the side labeled “Modem” or “DSL” to your ZyXEL Device.
- 3 Connect the side labeled “Line” to the telephone wall jack.

Telephone Microfilters

Telephone voice transmissions take place in the lower frequency range, 0 - 4KHz, while ADSL transmissions take place in the higher bandwidth range, above 4KHz. A microfilter acts as a low-pass filter, for your telephone, to ensure that ADSL transmissions do not interfere with your telephone voice transmissions. The use of a telephone microfilter is optional.

- 1 Locate and disconnect each telephone.
- 2 Connect a cable from the wall jack to the “wall side” of the microfilter.

- 3 Connect the “phone side” of the microfilter to your telephone as shown in the following figure.
- 4 After you are done, make sure that your telephone works. If your telephone does not work, disconnect the microfilter and contact either your local telephone company or the provider of the microfilter.

Figure 120 Connecting a Microfilter

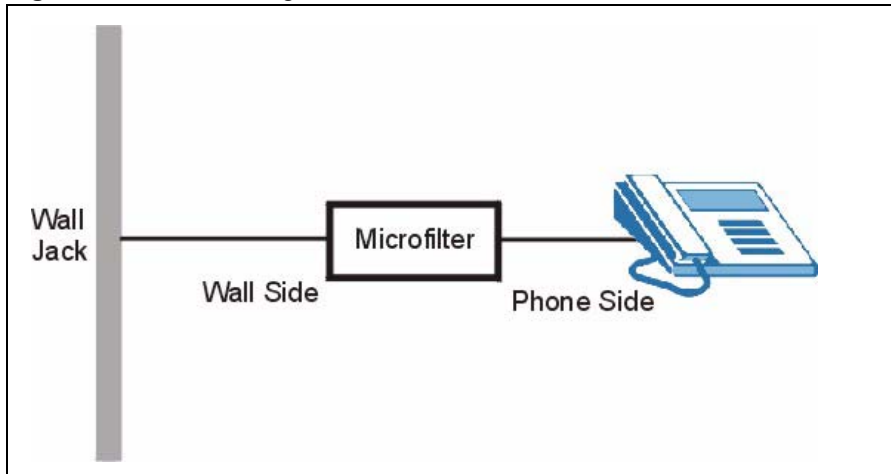

You can also use a Y-Connector with a microfilter in order to connect both your modem and a telephone to the same wall jack without using a POTS splitter.

- 1 Connect a phone cable from the wall jack to the single jack end of the Y-Connector.
- 2 Connect a cable from the double jack end of the Y-Connector to the “wall side” of the microfilter.
- 3 Connect another cable from the double jack end of the Y-Connector to the ZyXEL Device.
- 4 Connect the “phone side” of the microfilter to your telephone as shown in the following figure.

Figure 121 Connecting a Microfilter and Y-Connector

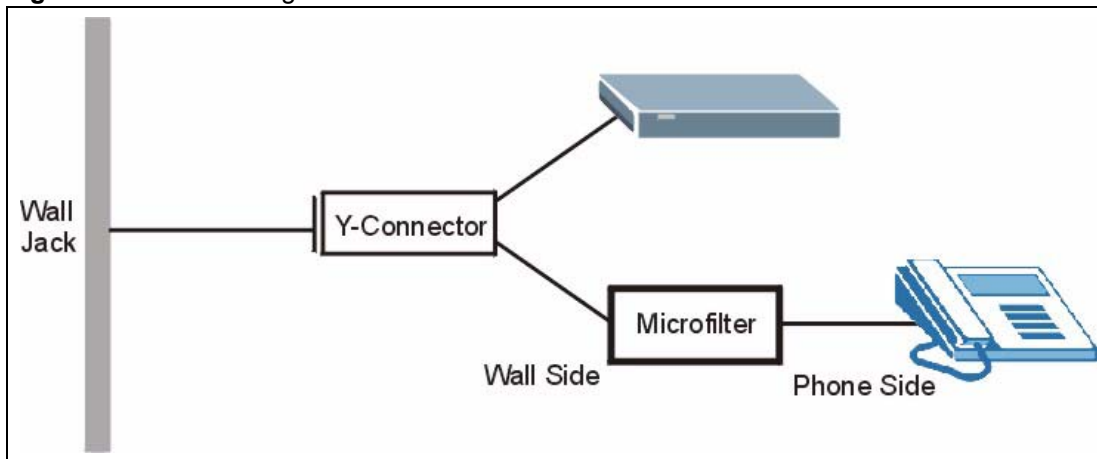

ZyXEL Device With ISDN

This section relates to people who use their ZyXEL Device with ADSL over ISDN (digital telephone service) only. The following is an example installation for the ZyXEL Device with ISDN.

Figure 122 ZyXEL Device with ISDN

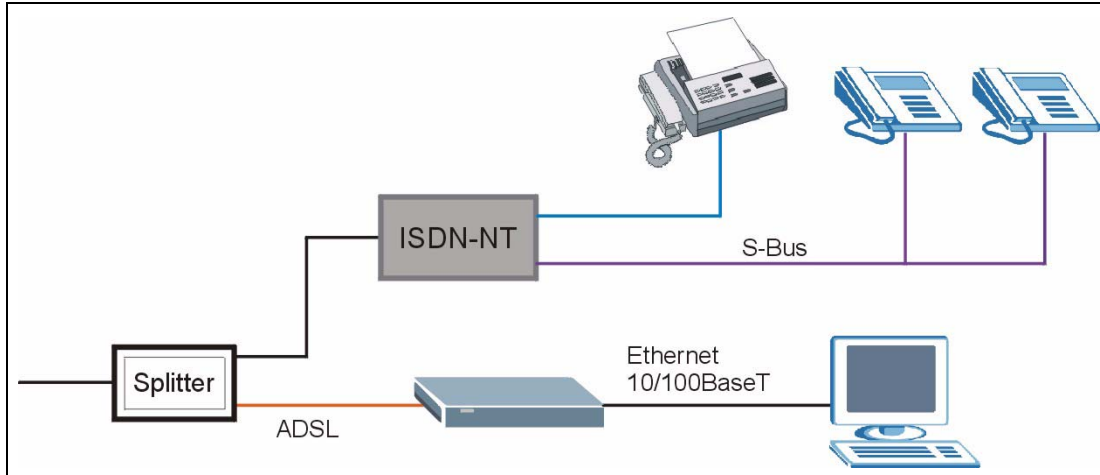

APPENDIX I

Pop-up Windows, JavaScripts and Java Permissions

In order to use the web configurator you need to allow:

- Web browser pop-up windows from your device.
- JavaScripts (enabled by default).
- Java permissions (enabled by default).

Note: Internet Explorer 6 screens are used here. Screens for other Internet Explorer versions may vary.

Internet Explorer Pop-up Blockers

You may have to disable pop-up blocking to log into your device.

Either disable pop-up blocking (enabled by default in Windows XP SP (Service Pack) 2) or allow pop-up blocking and create an exception for your device's IP address.

Disable pop-up Blockers

- 1 In Internet Explorer, select **Tools, Pop-up Blocker** and then select **Turn Off Pop-up Blocker**.

Figure 123 Pop-up Blocker

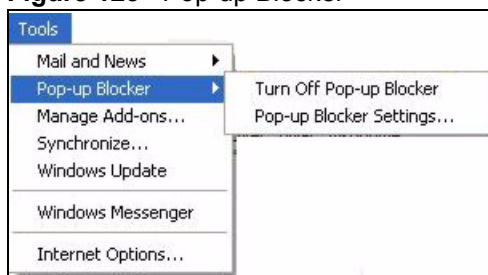

You can also check if pop-up blocking is disabled in the **Pop-up Blocker** section in the **Privacy** tab.

- 1 In Internet Explorer, select **Tools, Internet Options, Privacy**.
- 2 Clear the **Block pop-ups** check box in the **Pop-up Blocker** section of the screen. This disables any web pop-up blockers you may have enabled.

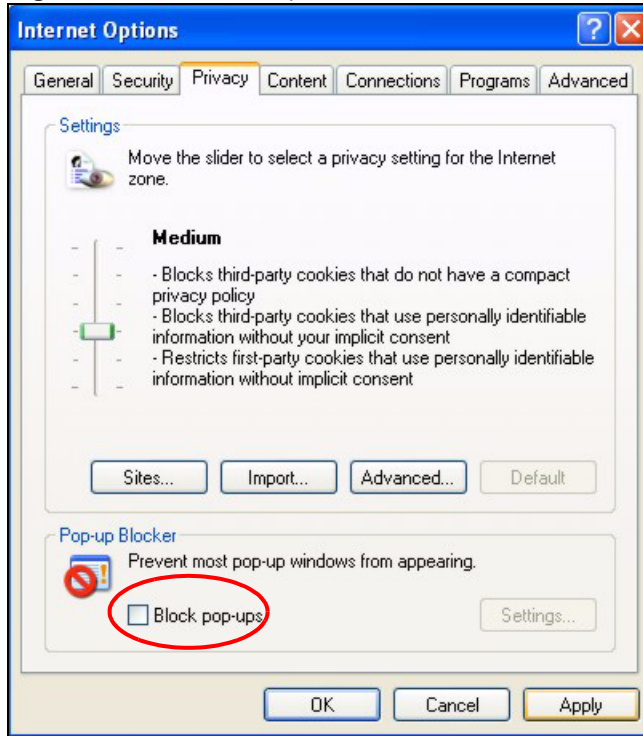
Figure 124 Internet Options

3 Click **Apply** to save this setting.

Enable pop-up Blockers with Exceptions

Alternatively, if you only want to allow pop-up windows from your device, see the following steps.

- 1** In Internet Explorer, select **Tools, Internet Options** and then the **Privacy** tab.
- 2** Select **Settings...** to open the **Pop-up Blocker Settings** screen.

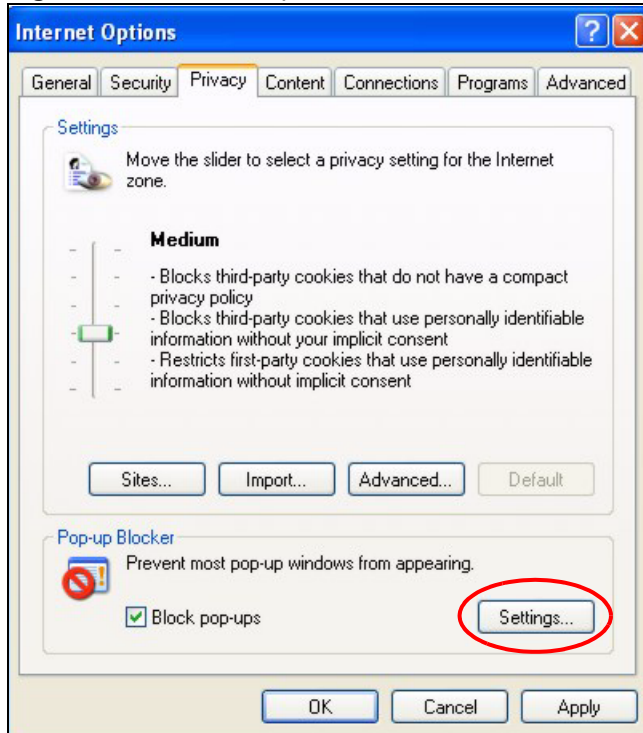
Figure 125 Internet Options

- 3** Type the IP address of your device (the web page that you do not want to have blocked) with the prefix “http://”. For example, http://192.168.1.1.
- 4** Click **Add** to move the IP address to the list of **Allowed sites**.

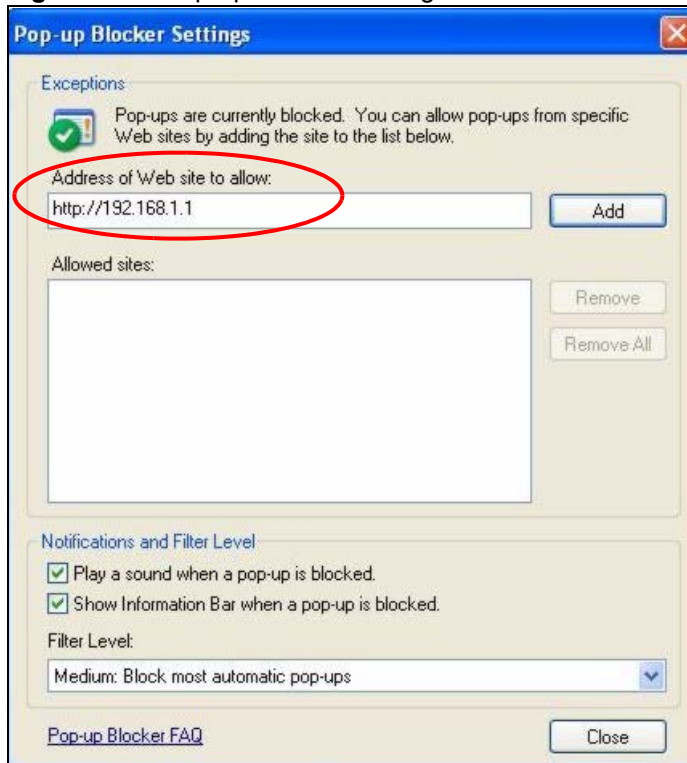
Figure 126 Pop-up Blocker Settings

5 Click **Close** to return to the **Privacy** screen.

6 Click **Apply** to save this setting.

JavaScripts

If pages of the web configurator do not display properly in Internet Explorer, check that JavaScripts are allowed.

1 In Internet Explorer, click **Tools, Internet Options** and then the **Security** tab.

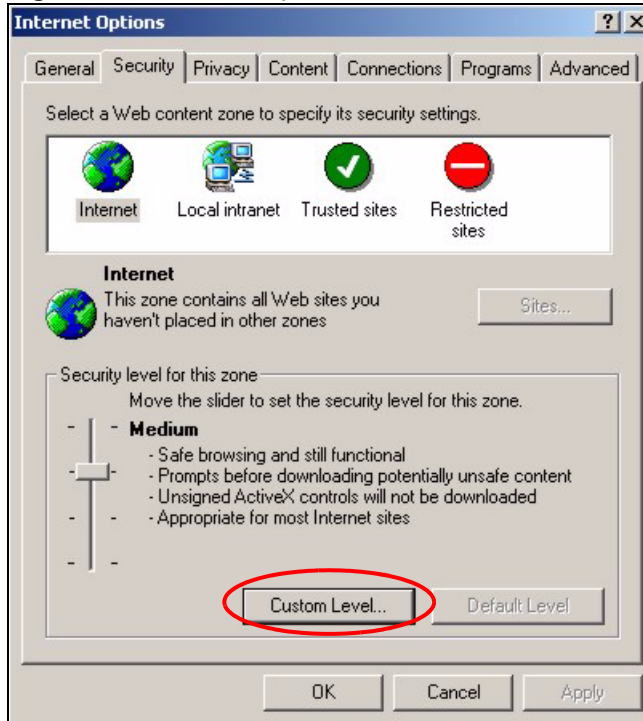
Figure 127 Internet Options

- 2** Click the **Custom Level...** button.
- 3** Scroll down to **Scripting**.
- 4** Under **Active scripting** make sure that **Enable** is selected (the default).
- 5** Under **Scripting of Java applets** make sure that **Enable** is selected (the default).
- 6** Click **OK** to close the window.

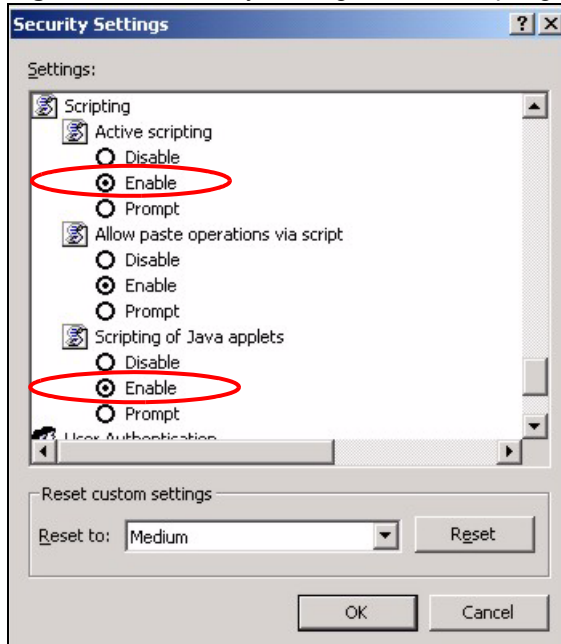
Figure 128 Security Settings - Java Scripting

Java Permissions

- 1 From Internet Explorer, click **Tools, Internet Options** and then the **Security** tab.
- 2 Click the **Custom Level...** button.
- 3 Scroll down to **Microsoft VM**.
- 4 Under **Java permissions** make sure that a safety level is selected.
- 5 Click **OK** to close the window.

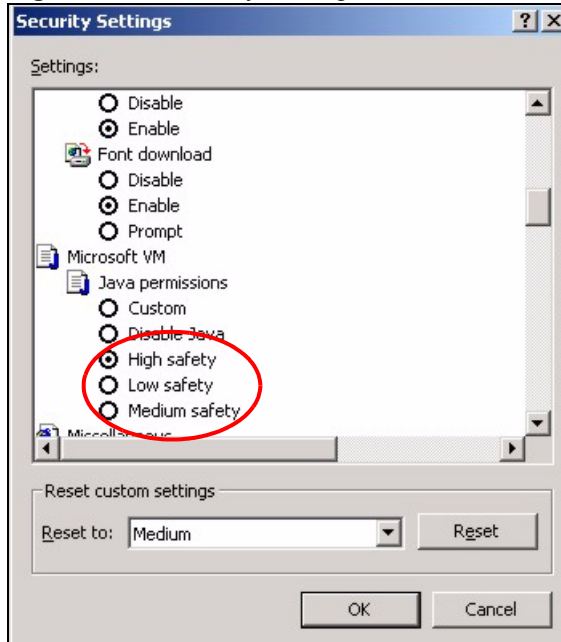
Figure 129 Security Settings - Java

JAVA (Sun)

- 1 From Internet Explorer, click **Tools**, **Internet Options** and then the **Advanced** tab.
- 2 make sure that **Use Java 2 for <applet>** under **Java (Sun)** is selected.
- 3 Click **OK** to close the window.

Figure 130 Java (Sun)

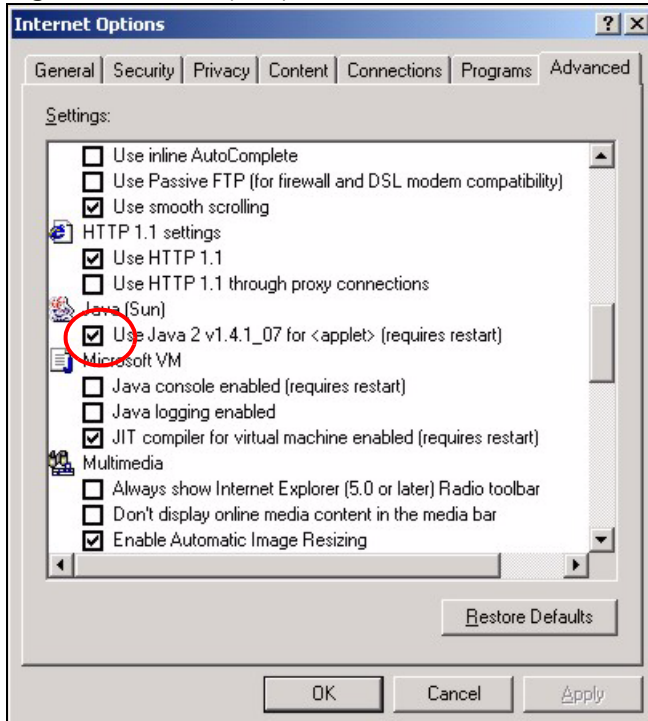

Index

A

address assignment [68](#)
Address Resolution Protocol (ARP) [71](#)
ADSL standards [25](#), [141](#)
alternative subnet mask notation [180](#)
Any IP [25](#)
 and NAT [71](#)
 how it works [70](#), [71](#)
 setup [73](#)
applications
 Internet access [27](#)
ATM Adaptation Layer 5 (AAL5) [49](#)

B

backup [130](#)
 text file format [142](#)
backup gateway [63](#)
backup type [64](#)

C

CBR (Continuous Bit Rate) [57](#), [61](#)
certifications [3](#)
 Notice 1 [3](#)
change password at login [31](#)
client
 DHCP [26](#)
configuration
 backup [130](#)
 restore [131](#)
 text file format [142](#)
contacting customer support [7](#)
copyright [2](#)
cost of transmission [51](#)
customer support [7](#)

D

default LAN IP address [30](#)
default settings [132](#)
DHCP [67](#), [68](#), [96](#), [122](#)
 client [26](#)
 configuration [67](#)
 relay [26](#)
 server [26](#)
DHCP (Dynamic Host Configuration Protocol) [26](#)
diagnostics [134](#)
disclaimer [2](#)
DNS (Domain Name System) [67](#)
DNS and remote management [107](#)
domain name [68](#), [122](#)
 service type [85](#)
domain name and DHCP clients [122](#)
DSL line, reinitialize [135](#)
DSLAM (Digital Subscriber Line Access Multiplexer) [27](#)
dynamic DNS [26](#), [96](#)
Dynamic Host Configuration Protocol [26](#)
DYNDNS wildcard [96](#)

E

ECHO [85](#)
embedded help [33](#)
Encapsulated Routing Link Protocol (ENET ENCAP) [48](#)
encapsulation [48](#), [49](#)
 ENET ENCAP [48](#)
 PPP over Ethernet [48](#)
 PPPoA [49](#)
 RFC 1483 [49](#)

F

factory default settings [132](#)
FCC [3](#)
FCC Rules [3](#)
features [141](#)
Federal Communications Commission [3](#)

Finger, protocol [85](#)
firmware [128](#)
 upgrade [128](#)
 upload [128](#)
 upload error [129](#)
FTP [85](#), [100](#), [103](#)
 and NAT [85](#)
 and remote management [103](#)
FTP restrictions [100](#)

G

general setup [122](#)

H

help, web configurator [33](#)
HTTP [85](#)
 and remote management [100](#)
HTTP (Hypertext Transfer Protocol) [128](#)

I

IANA [69](#)
IGMP
 and multicasting [70](#)
 versions [70](#)
IGMP (Internet Group Multicast Protocol) [70](#)
Integrated Services Digital Network
 See ISDN
Interference Statement [3](#)
internal SPTGEN [142](#)
 FTP upload example [144](#)
 points to remember [143](#)
 text file [142](#)
Internet access [25](#), [27](#), [40](#)
 setup [137](#)
 troubleshooting [137](#)
 wizard setup [40](#)
 Zero Configuration [25](#)
Internet Assigned Numbers Authority See IANA [69](#)
IP
 address [68](#)
 address assignment [50](#)
 address assignment ENET ENCAP [51](#)
 address assignment PPPoA [50](#)
 address assignment PPPoE [50](#)
 address assignment RFC 1483 [50](#)

 address pool [67](#)
 and static route [92](#)
 ANY IP feature [25](#)
 default LAN address [30](#)
 pool of addresses [74](#)
IP address [85](#)
 and NAT [87](#)
 default server [85](#)
 NAT [86](#)
IP alias [26](#)
IP Pool Setup [67](#)
ISDN (Integrated Services Digital Network) [24](#)

L

LAN
 DHCP [67](#)
 TCP/IP [68](#)
login [31](#)

M

management
 types of [141](#)
Management Information Base (MIB) [105](#)
Maximum Burst Size (MBS) [52](#), [57](#), [62](#)
metric [51](#)
metric, cost of transmission [51](#)
MIB (Management Information Base) [105](#)
multicast [70](#)
multiplexing [49](#)
 LLC-based [49](#)
 VC-based [49](#)
multiprotocol encapsulation [49](#)

N

nailed-up connection [51](#)
NAT [68](#), [85](#)
 address mapping rule [90](#)
 and servers [82](#)
 application [82](#)
 configuration [84](#)
 definitions [80](#)
 example [86](#)
 how it works [81](#)
 mapping types [82](#)

- mode [84](#)
- port forwarding [85](#)
- port numbers [85](#)
- specifications [141](#)
- what it does [81](#)

NAT (Network Address Translation) [80](#)

NAT Traversal [110](#)

navigating the web configurator [32](#)

Network Address Translation (NAT) [26](#)

NNTP [85](#)

P

password

- change at login [31](#)

Peak Cell Rate (PCR) [52](#), [57](#), [62](#)

Point to Point Protocol over ATM Adaptation Layer 5 (AAL5) [49](#)

Point-to-Point Tunneling Protocol [85](#)

POP3 [85](#)

port number [85](#)

PPPoA [50](#)

PPPoE [48](#)

- benefits [48](#)

PPPoE (Point-to-Point Protocol over Ethernet) [26](#)

PPTP [85](#)

product specifications [140](#)

- dimensions [140](#)
- operating conditions [140](#)
- power [140](#)

protocols supported [141](#)

Q

Quick Start Guide [22](#)

- hardware connections [30](#)

R

reinitialize the ADSL line

- diagnostics
 - ADSL line [135](#)

related documentation [22](#)

remote management [100](#)

- and FTP [103](#)
- and LAN [100](#)
- and SNMP [104](#)

- and WAN [100](#)
- disabling [100](#)
- enabling [100](#)
- types of sessions [100](#)

remote management and NAT [101](#)

remote management limitations [100](#)

reset button [32](#)

resetting

- and factory default settings [132](#)

resetting the ZyXEL Device [32](#)

restore configuration [131](#)

RFC 1483 [49](#)

RFC 1631 [80](#)

RFC-1483 [50](#)

RFC-2364 [50](#)

RFC2516, PPPoE [26](#)

RIP

- direction [69](#)
- version [69](#)

RIP (Routing Information Protocol) [69](#)

Routing Information Protocol

- See also RIP [69](#)

Routing Information Protocol (RIP) [69](#)

S

safety warnings [5](#)

server

- DHCP [26](#)

servers

- and NAT [83](#)
- time server [125](#)

service type, WAN [137](#)

services

- and NAT [85](#)
- port numbers [85](#)

SMTP [85](#)

SNMP [85](#), [104](#)

- agent [105](#)
- and remote management [104](#)
- manager [105](#)
- MIBs [105](#)

SNMP (Simple Network Management Protocol) [104](#)

SNMP manager [105](#)

splitters [190](#)

splitters and microfilters [190](#)

SPTGEN (System Parameter Table Generator) [142](#)

standards, ADSL [141](#)

static route

- example [92](#)
- how it works [92](#)

- remote nodes [92](#)
- SUA [83](#)
- SUA (Single User Account) [83](#)
- SUA vs NAT
 - SUA (Single User Account) [83](#)
- subnet [178](#)
- subnet mask [68, 180](#)
- subnetting [180](#)
- supported protocols [141](#)
- supporting disk [22](#)
- Sustain Cell Rate (SCR) [57, 62](#)
- Sustained Cell Rate (SCR) [52](#)
- syntax conventions [22](#)
- system name [123](#)
- System Parameter Table Generator (SPTGEN) [142](#)
- system timeout [101](#)

T

- Telnet [102](#)
 - and remote management [100, 102](#)
- text file format, backup [142](#)
- TFTP restrictions [100](#)
- trademarks [2](#)
- traffic redirect [25, 62, 63, 64](#)
 - example [62](#)
- traffic shaping [52](#)
- troubleshooting [137](#)
 - Internet access [137](#)

U

- UBR (Unspecified Bit Rate) [57, 61](#)
- Universal Plug and Play [110](#)
 - Application [110](#)
- Universal Plug and Play (UPnP) [26](#)
- UPnP [110](#)
 - Forum [111](#)
 - installation [112](#)
 - installation, Windows Me [112](#)
 - installation, Windows XP [114](#)
 - security issues [111](#)
- user name [97](#)

V

- VBR (Variable Bit Rate) [57, 61](#)
- VC-based multiplexing [50](#)
- viewing certifications [3](#)
- Virtual Channel Identifier (VCI) [50](#)
- virtual circuit (VC) [49](#)
- Virtual Path Identifier (VPI) [50](#)
- VPI & VCI [50](#)

W

- WAN
 - backup type [64](#)
 - encapsulation [48](#)
 - ENET ENCAP [48](#)
 - PPP over Ethernet [48](#)
 - PPPoA [49](#)
 - Setup [48](#)
 - troubleshooting [137](#)
- WAN (Wide Area Network) [48](#)
- WAN backup [63](#)
- web and remote management [101](#)
- web configurator [30, 32](#)
 - help [33](#)
 - main screen [33](#)
 - navigating [32](#)
 - screen summary [33](#)

Z

- Zero Configuration Internet Access [25, 53](#)
- ZyNOS (ZyXEL Network Operating System) [2](#)
- ZyXEL Home Page [4](#)
- ZyXEL Network Operating System [2](#)