

GS-4012F/4024

Ethernet Switch

User's Guide

Version 3.70
9/2006

The logo for ZyXEL, featuring the word "ZyXEL" in a bold, blue, sans-serif font. The "Zy" is lowercase and the "XEL" is uppercase.

Copyright

Copyright © 2006 by ZyXEL Communications Corporation.

The contents of this publication may not be reproduced in any part or as a whole, transcribed, stored in a retrieval system, translated into any language, or transmitted in any form or by any means, electronic, mechanical, magnetic, optical, chemical, photocopying, manual, or otherwise, without the prior written permission of ZyXEL Communications Corporation.

Published by ZyXEL Communications Corporation. All rights reserved.

Disclaimer

ZyXEL does not assume any liability arising out of the application or use of any products, or software described herein. Neither does it convey any license under its patent rights nor the patent rights of others. ZyXEL further reserves the right to make changes in any products described herein without notice. This publication is subject to change without notice.

Trademarks

ZyNOS (ZyXEL Network Operating System) is a registered trademark of ZyXEL Communications, Inc. Other trademarks mentioned in this publication are used for identification purposes only and may be properties of their respective owners.

Certifications

Federal Communications Commission (FCC) Interference Statement

This device complies with Part 15 of FCC rules. Operation is subject to the following two conditions:

- This device may not cause harmful interference.
- This device must accept any interference received, including interference that may cause undesired operations.

FCC Warning

This device has been tested and found to comply with the limits for a Class A digital switch, pursuant to Part 15 of the FCC Rules. These limits are designed to provide reasonable protection against harmful interference in a commercial environment. This device generates, uses, and can radiate radio frequency energy and, if not installed and used in accordance with the instruction manual, may cause harmful interference to radio communications. Operation of this device in a residential area is likely to cause harmful interference in which case the user will be required to correct the interference at his own expense.

CE Mark Warning:

This is a class A product. In a domestic environment this product may cause radio interference in which case the user may be required to take adequate measures.

Taiwanese BSMI (Bureau of Standards, Metrology and Inspection) A Warning:

警告使用者
這是甲類的資訊產品，在居住的環境使用時，
可能造成射頻干擾，在這種情況下，
使用者會被要求採取某些適當的對策。

Notices

Changes or modifications not expressly approved by the party responsible for compliance could void the user's authority to operate the equipment.

This Class A digital apparatus complies with Canadian ICES-003.

Cet appareil numérique de la classe A est conforme à la norme NMB-003 du Canada.

Viewing Certifications

- 1 Go to <http://www.zyxel.com>.

- 2** Select your product from the drop-down list box on the ZyXEL home page to go to that product's page.
- 3** Select the certification you wish to view from this page.

Safety Warnings

For your safety, be sure to read and follow all warning notices and instructions.

- Do NOT use this product near water, for example, in a wet basement or near a swimming pool.
- Do NOT expose your device to dampness, dust or corrosive liquids.
- Do NOT store things on the device.
- Do NOT install, use, or service this device during a thunderstorm. There is a remote risk of electric shock from lightning.
- Connect ONLY suitable accessories to the device.
- Do NOT open the device or unit. Opening or removing covers can expose you to dangerous high voltage points or other risks. ONLY qualified service personnel should service or disassemble this device. Please contact your vendor for further information. Make sure to connect the cables to the correct ports.
- Place connecting cables carefully so that no one will step on them or stumble over them.
- Always disconnect all cables from this device before servicing or disassembling.
- Use ONLY an appropriate power adaptor or cord for your device.
- Connect the power adaptor or cord to the right supply voltage (for example, 110V AC in North America or 230V AC in Europe).
- Do NOT allow anything to rest on the power adaptor or cord and do NOT place the product where anyone can walk on the power adaptor or cord.
- Do NOT use the device if the power adaptor or cord is damaged as it might cause electrocution.
- If the power adaptor or cord is damaged, remove it from the power outlet.
- Do NOT attempt to repair the power adaptor or cord. Contact your local vendor to order a new one.
- Do not use the device outside, and make sure all the connections are indoors. There is a remote risk of electric shock from lightning.
- **CAUTION: RISK OF EXPLOSION IF BATTERY (on the motherboard) IS REPLACED BY AN INCORRECT TYPE. DISPOSE OF USED BATTERIES ACCORDING TO THE INSTRUCTIONS.** Dispose them at the applicable collection point for the recycling of electrical and electronic equipment. For detailed information about recycling of this product, please contact your local city office, your household waste disposal service or the store where you purchased the product.
- Do NOT obstruct the device ventilation slots, as insufficient airflow may harm your device.
- The length of exposed (bare) power wire should not exceed 7mm.

This product is recyclable. Dispose of it properly.

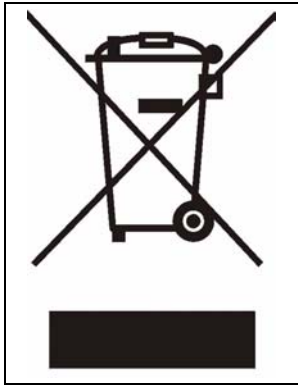

ZyXEL Limited Warranty

ZyXEL warrants to the original end user (purchaser) that this product is free from any defects in materials or workmanship for a period of up to two years from the date of purchase. During the warranty period, and upon proof of purchase, should the product have indications of failure due to faulty workmanship and/or materials, ZyXEL will, at its discretion, repair or replace the defective products or components without charge for either parts or labor, and to whatever extent it shall deem necessary to restore the product or components to proper operating condition. Any replacement will consist of a new or re-manufactured functionally equivalent product of equal or higher value, and will be solely at the discretion of ZyXEL. This warranty shall not apply if the product has been modified, misused, tampered with, damaged by an act of God, or subjected to abnormal working conditions.

Note

Repair or replacement, as provided under this warranty, is the exclusive remedy of the purchaser. This warranty is in lieu of all other warranties, express or implied, including any implied warranty of merchantability or fitness for a particular use or purpose. ZyXEL shall in no event be held liable for indirect or consequential damages of any kind to the purchaser.

To obtain the services of this warranty, contact ZyXEL's Service Center for your Return Material Authorization number (RMA). Products must be returned Postage Prepaid. It is recommended that the unit be insured when shipped. Any returned products without proof of purchase or those with an out-dated warranty will be repaired or replaced (at the discretion of ZyXEL) and the customer will be billed for parts and labor. All repaired or replaced products will be shipped by ZyXEL to the corresponding return address, Postage Paid. This warranty gives you specific legal rights, and you may also have other rights that vary from country to country.

Registration

Register your product online to receive e-mail notices of firmware upgrades and information at www.zyxel.com for global products, or at www.us.zyxel.com for North American products.

Customer Support

Please have the following information ready when you contact customer support.

- Product model and serial number.
- Warranty Information.
- Date that you received your device.
- Brief description of the problem and the steps you took to solve it.

METHOD	SUPPORT E-MAIL	TELEPHONE	WEB SITE	REGULAR MAIL
LOCATION	SALES E-MAIL	FAX	FTP SITE	
CORPORATE HEADQUARTERS (WORLDWIDE)	support@zyxel.com.tw	+886-3-578-3942	www.zyxel.com www.europe.zyxel.com	ZyXEL Communications Corp. 6 Innovation Road II Science Park Hsinchu 300 Taiwan
	sales@zyxel.com.tw	+886-3-578-2439	ftp.zyxel.com ftp.europe.zyxel.com	
COSTA RICA	soporte@zyxel.co.cr	+506-2017878	www.zyxel.co.cr	ZyXEL Costa Rica Plaza Roble Escazú Etapa El Patio, Tercer Piso San José, Costa Rica
	sales@zyxel.co.cr	+506-2015098	ftp.zyxel.co.cr	
CZECH REPUBLIC	info@cz.zyxel.com	+420-241-091-350	www.zyxel.cz	ZyXEL Communications Czech s.r.o. Modranská 621 143 01 Praha 4 - Modrany Česká Republika
	info@cz.zyxel.com	+420-241-091-359		
DENMARK	support@zyxel.dk	+45-39-55-07-00	www.zyxel.dk	ZyXEL Communications A/S Columbusvej 2860 Soeborg Denmark
	sales@zyxel.dk	+45-39-55-07-07		
FINLAND	support@zyxel.fi	+358-9-4780-8411	www.zyxel.fi	ZyXEL Communications Oy Malminkaari 10 00700 Helsinki Finland
	sales@zyxel.fi	+358-9-4780 8448		
FRANCE	info@zyxel.fr	+33-4-72-52-97-97	www.zyxel.fr	ZyXEL France 1 rue des Vergers Bat. 1 / C 69760 Limonest France
		+33-4-72-52-19-20		
GERMANY	support@zyxel.de	+49-2405-6909-0	www.zyxel.de	ZyXEL Deutschland GmbH. Adenauerstr. 20/A2 D-52146 Wuerselen Germany
	sales@zyxel.de	+49-2405-6909-99		
HUNGARY	support@zyxel.hu	+36-1-3361649	www.zyxel.hu	ZyXEL Hungary 48, Zoldlomb Str. H-1025, Budapest Hungary
	info@zyxel.hu	+36-1-3259100		
KAZAKHSTAN	http://zyxel.kz/support	+7-3272-590-698	www.zyxel.kz	ZyXEL Kazakhstan 43, Dostyk ave., Office 414 Dostyk Business Centre 050010, Almaty Republic of Kazakhstan
	sales@zyxel.kz	+7-3272-590-689		
NORTH AMERICA	support@zyxel.com	1-800-255-4101 +1-714-632-0882	www.us.zyxel.com	ZyXEL Communications Inc. 1130 N. Miller St. Anaheim CA 92806-2001 U.S.A.
	sales@zyxel.com	+1-714-632-0858	ftp.us.zyxel.com	

LOCATION	METHOD	SUPPORT E-MAIL	TELEPHONE	WEB SITE	REGULAR MAIL
		SALES E-MAIL	FAX	FTP SITE	
NORWAY		support@zyxel.no	+47-22-80-61-80	www.zyxel.no	ZyXEL Communications A/S Niils Hansens vei 13 0667 Oslo Norway
		sales@zyxel.no	+47-22-80-61-81		
POLAND		info@pl.zyxel.com	+48 (22) 333 8250	www.pl.zyxel.com	ZyXEL Communications ul. Okrzei 1A 03-715 Warszawa Poland
			+48 (22) 333 8251		
RUSSIA		http://zyxel.ru/support	+7-095-542-89-29	www.zyxel.ru	ZyXEL Russia Ostrovityanova 37a Str. Moscow, 117279 Russia
		sales@zyxel.ru	+7-095-542-89-25		
SPAIN		support@zyxel.es	+34-902-195-420	www.zyxel.es	ZyXEL Communications Arte, 21 5ª planta 28033 Madrid Spain
		sales@zyxel.es	+34-913-005-345		
SWEDEN		support@zyxel.se	+46-31-744-7700	www.zyxel.se	ZyXEL Communications A/S Sjöporten 4, 41764 Göteborg Sweden
		sales@zyxel.se	+46-31-744-7701		
UKRAINE		support@ua.zyxel.com	+380-44-247-69-78	www.ua.zyxel.com	ZyXEL Ukraine 13, Pimonenko Str. Kiev, 04050 Ukraine
		sales@ua.zyxel.com	+380-44-494-49-32		
UNITED KINGDOM		support@zyxel.co.uk	+44-1344 303044 08707 555779 (UK only)	www.zyxel.co.uk	ZyXEL Communications UK Ltd., 11 The Courtyard, Eastern Road, Bracknell, Berkshire, RG12 2XB, United Kingdom (UK)
		sales@zyxel.co.uk	+44-1344 303034	ftp.zyxel.co.uk	

+" is the (prefix) number you enter to make an international telephone call.

Table of Contents

Copyright	1
Certifications	2
Safety Warnings	4
ZyXEL Limited Warranty	6
Customer Support	7
Table of Contents	9
List of Figures	21
List of Tables	25
Preface	29
Chapter 1	
Getting to Know Your Switch	31
1.1 Introduction	31
1.1.1 Backbone Application	31
1.1.2 Bridging Example	32
1.1.3 High Performance Switching Example	33
1.1.4 IEEE 802.1Q VLAN Application Examples	33
1.1.4.1 Tag-based VLAN Example	33
Chapter 2	
Hardware Installation and Connection	35
2.1 Freestanding Installation	35
2.2 Mounting the Switch on a Rack	36
2.2.1 Rack-mounted Installation Requirements	36
2.2.1.1 Precautions	36
2.2.2 Attaching the Mounting Brackets to the Switch	36
2.2.3 Mounting the Switch on a Rack	36
Chapter 3	
Hardware Overview	39
3.1 Front Panel Connection	39
3.1.1 Console Port	40
3.1.2 Gigabit Ethernet Ports	40

3.1.2.1 Default Ethernet Settings	41
3.1.3 SFP Slots	41
3.1.3.1 Transceiver Installation	41
3.1.3.2 Transceiver Removal	42
3.2 Rear Panel	43
3.2.1 Power Connector	43
3.2.2 External Backup Power Supply Connector	44
3.3 LEDs	44
Chapter 4	
The Web Configurator.....	47
4.1 Introduction	47
4.2 System Login	47
4.3 The Status Screen	48
4.3.1 Change Your Password	52
4.4 Saving Your Configuration	53
4.5 Switch Lockout	53
4.6 Resetting the Switch	54
4.6.1 Reload the Configuration File	54
4.7 Logging Out of the Web Configurator	55
4.8 Help	55
Chapter 5	
Initial Setup Example	57
5.1 Overview	57
5.1.1 Configuring an IP Interface	57
5.1.2 Configuring DHCP Server Settings	58
5.1.3 Creating a VLAN	59
5.1.4 Setting Port VID	60
5.1.5 Enabling RIP	60
Chapter 6	
System Status and Port Statistics	63
6.1 Overview	63
6.2 Port Status Summary	63
6.2.1 Status: Port Details	64
Chapter 7	
Basic Setting	69
7.1 Overview	69
7.2 System Information	69
7.3 General Setup	71
7.4 Introduction to VLANs	73

7.5 Switch Setup Screen	74
7.6 IP Setup	75
7.6.1 IP Interfaces	76
7.7 Port Setup	78
Chapter 8	
VLAN	81
8.1 Introduction to IEEE 802.1Q Tagged VLANs	81
8.1.1 Forwarding Tagged and Untagged Frames	81
8.2 Automatic VLAN Registration	82
8.2.1 GARP	82
8.2.1.1 GARP Timers	82
8.2.2 GVRP	82
8.3 Port VLAN Trunking	83
8.4 Select the VLAN Type	83
8.5 Static VLAN	84
8.5.1 Static VLAN Status	84
8.5.2 Static VLAN Details	85
8.5.3 Configure a Static VLAN	85
8.5.4 Configure VLAN Port Settings	87
8.6 Port-based VLAN Setup	88
8.6.1 Configure a Port-based VLAN	89
Chapter 9	
Static MAC Forward Setup	93
9.1 Overview	93
9.2 Configuring Static MAC Forwarding	93
Chapter 10	
Filtering	95
10.1 Configure a Filtering Rule	95
Chapter 11	
Spanning Tree Protocol	97
11.1 STP/RSTP Overview	97
11.1.1 STP Terminology	97
11.1.2 How STP Works	98
11.1.3 STP Port States	98
11.1.4 Multiple RSTP	99
11.2 Spanning Tree Protocol Main Screen	99
11.3 Configure Rapid Spanning Tree Protocol	100
11.4 Rapid Spanning Tree Protocol Status	102
11.5 Configure Multiple Rapid Spanning Tree Protocol	103

11.6 Multiple Rapid Spanning Tree Protocol Status	105
Chapter 12	
Bandwidth Control	107
12.1 Bandwidth Control Overview	107
12.1.1 CIR and PIR	107
12.2 Bandwidth Control Setup	107
Chapter 13	
Broadcast Storm Control.....	109
13.1 Broadcast Storm Control Setup	109
Chapter 14	
Mirroring	111
14.1 Port Mirroring Setup	111
Chapter 15	
Link Aggregation.....	113
15.1 Link Aggregation Overview	113
15.2 Dynamic Link Aggregation	113
15.2.1 Link Aggregation ID	114
15.3 Link Aggregation Control Protocol Status	114
15.4 Link Aggregation Setup	115
Chapter 16	
Port Authentication	119
16.1 Port Authentication Overview	119
16.1.1 RADIUS	119
16.1.1.1 Vendor Specific Attribute	119
16.1.1.2 Tunnel Protocol Attribute	120
16.2 Port Authentication Configuration	120
16.2.1 Configuring RADIUS Server Settings	121
16.2.2 Activate IEEE 802.1x Security	122
Chapter 17	
Port Security.....	125
17.1 About Port Security	125
17.2 Port Security Setup	125
Chapter 18	
Classifier	129
18.1 About the Classifier and QoS	129
18.2 Configuring the Classifier	129

18.3 Viewing and Editing Classifier Configuration	132
18.4 Classifier Example	133
Chapter 19	
Policy Rule	135
19.1 Policy Rules Overview	135
19.1.1 DiffServ	135
19.1.2 DSCP and Per-Hop Behavior	135
19.2 Configuring Policy Rules	136
19.3 Viewing and Editing Policy Configuration	139
19.4 Policy Example	140
Chapter 20	
Queuing Method	143
20.1 Queuing Method Overview	143
20.1.1 Strictly Priority Queuing	143
20.1.2 Weighted Round Robin Scheduling (WRR)	143
20.2 Configuring Queuing	144
Chapter 21	
VLAN Stacking	147
21.1 VLAN Stacking Overview	147
21.1.1 VLAN Stacking Example	147
21.2 VLAN Stacking Port Roles	148
21.3 VLAN Tag Format	148
21.3.1 Frame Format	149
21.4 Configuring VLAN Stacking	150
Chapter 22	
Multicast	153
22.1 Multicast Overview	153
22.1.1 IP Multicast Addresses	153
22.1.2 IGMP Filtering	153
22.1.3 IGMP Snooping	153
22.2 Multicast Status	154
22.3 Multicast Setting	154
22.4 IGMP Filtering Profile	157
22.5 MVR Overview	158
22.5.1 Types of MVR Ports	158
22.5.2 MVR Modes	158
22.5.3 How MVR Works	159
22.6 General MVR Configuration	159
22.7 MVR Group Configuration	161

22.7.1 MVR Configuration Example	163
Chapter 23	
Static Route	165
23.1 Configuring Static Routing	165
Chapter 24	
RIP	167
24.1 RIP Overview	167
24.2 Configuring RIP	167
Chapter 25	
OSPF	169
25.1 OSPF Overview	169
25.1.1 OSPF Autonomous Systems and Areas	169
25.1.2 How OSPF Works	170
25.1.3 Interfaces and Virtual Links	170
25.1.4 OSPF and Router Elections	170
25.1.5 Configuring OSPF	171
25.2 OSPF Status	171
25.3 OSPF Configuration	173
25.4 Configure OSPF Areas	175
25.4.1 View OSPF Area Information Table	176
25.5 Configuring OSPF Interfaces	177
25.6 OSPF Virtual-Links	178
Chapter 26	
IGMP	181
26.1 IGMP Overview	181
26.2 Configuring IGMP	181
Chapter 27	
DVMRP	183
27.1 DVMRP Overview	183
27.2 How DVMRP Works	183
27.2.1 DVMRP Terminology	184
27.3 Configuring DVMRP	184
27.3.1 DVMRP Configuration Error Messages	185
27.4 Default DVMRP Timer Values	186
Chapter 28	
IP Multicast	187
28.1 IP Multicast Overview	187

28.2 Configuring Multicast	187
Chapter 29	
Differentiated Services	189
29.1 DiffServ Overview	189
29.1.1 DSCP and Per-Hop Behavior	189
29.1.2 DiffServ Network Example	189
29.2 Activating DiffServ	190
29.3 DSCP-to-IEEE802.1p Priority Settings	191
29.3.1 Configuring DSCP Settings	191
Chapter 30	
DHCP	193
30.1 DHCP Overview	193
30.1.1 DHCP modes	193
30.2 DHCP Server Status	193
30.3 Configuring DHCP Server	194
30.3.1 DHCP Server Configuration Example	196
30.4 DHCP Relay	196
30.4.1 DHCP Relay Agent Information	197
30.4.2 Configuring DHCP Relay	197
30.4.3 DHCP Relay Configuration Example	198
Chapter 31	
VRRP	199
31.1 VRRP Overview	199
31.2 VRRP Status	200
31.3 VRRP Configuration	201
31.3.1 IP Interface Setup	201
31.3.2 VRRP Parameters	203
31.3.2.1 Advertisement Interval	203
31.3.2.2 Priority	203
31.3.2.3 Preempt Mode	203
31.3.3 Configuring VRRP Parameters	203
31.4 VRRP Configuration Summary	204
31.5 VRRP Configuration Examples	205
31.5.1 One Subnet Network Example	205
31.5.2 Two Subnets Example	207
Chapter 32	
Maintenance	209
32.1 The Maintenance Screen	209
32.2 Load Factory Default	210

32.3 Save Configuration	210
32.4 Reboot System	211
32.5 Firmware Upgrade	211
32.6 Restore a Configuration File	212
32.7 Backup a Configuration File	212
32.8 FTP Command Line	213
32.8.1 Filename Conventions	213
32.8.1.1 Example FTP Commands	213
32.8.2 FTP Command Line Procedure	214
32.8.3 GUI-based FTP Clients	214
32.8.4 FTP Restrictions	214
Chapter 33	
Access Control.....	215
33.1 Access Control Overview	215
33.2 The Access Control Main Screen	215
33.3 About SNMP	216
33.3.1 Supported MIBs	217
33.3.2 SNMP Traps	217
33.3.3 Configuring SNMP	218
33.3.4 Setting Up Login Accounts	218
33.4 SSH Overview	220
33.5 How SSH works	220
33.6 SSH Implementation on the Switch	221
33.6.1 Requirements for Using SSH	222
33.7 Introduction to HTTPS	222
33.8 HTTPS Example	223
33.8.1 Internet Explorer Warning Messages	223
33.8.2 Netscape Navigator Warning Messages	223
33.8.3 The Main Screen	224
33.9 Service Port Access Control	225
33.10 Remote Management	226
Chapter 34	
Diagnostic.....	229
34.1 Diagnostic	229
Chapter 35	
Syslog	231
35.1 Syslog Overview	231
35.2 Syslog Setup	231
35.3 Syslog Server Setup	232

Chapter 36	
Cluster Management	235
36.1 Cluster Management Status Overview	235
36.2 Cluster Management Status	236
36.2.1 Cluster Member Switch Management	237
36.2.1.1 Uploading Firmware to a Cluster Member Switch	238
36.3 Clustering Management Configuration	239
Chapter 37	
MAC Table	243
37.1 MAC Table Overview	243
37.2 Viewing the MAC Table	244
Chapter 38	
IP Table	245
38.1 IP Table Overview	245
38.2 Viewing the IP Table	246
Chapter 39	
ARP Table	247
39.1 ARP Table Overview	247
39.1.1 How ARP Works	247
39.2 Viewing the ARP Table	247
Chapter 40	
Routing Table	249
40.1 Overview	249
40.2 Viewing the Routing Table	249
Chapter 41	
Configure Clone	251
41.1 Configure Clone	251
Chapter 42	
Introducing Commands	253
42.1 Overview	253
42.2 Accessing the CLI	253
42.2.1 The Console Port	253
42.2.1.1 Initial Screen	254
42.3 The Login Screen	254
42.4 Command Syntax Conventions	254
42.5 Changing the Password	255
42.6 Privilege Levels	255

42.7 Command Modes	256
42.8 Getting Help	257
42.8.1 List of Available Commands	258
42.9 Using Command History	259
42.10 Saving Your Configuration	259
42.10.1 Switch Configuration File	259
42.10.2 Logging Out	260
42.11 Command Summary	260
42.11.1 User Mode	260
42.11.2 Enable Mode	261
42.11.3 General Configuration Mode	267
42.11.4 interface port-channel Commands	283
42.11.5 interface route-domain Commands	287
42.11.6 config-vlan Commands	288
42.12 mvr Commands	289

Chapter 43

User and Enable Mode Commands 291

43.1 Overview	291
43.2 show Commands	291
43.2.1 show system-information	291
43.2.2 show ip	292
43.2.3 show logging	292
43.2.4 show interface	292
43.2.5 show mac address-table	293
43.3 ping	294
43.4 traceroute	294
43.5 Copy Port Attributes	295
43.6 Configuration File Maintenance	296
43.6.1 Using a Different Configuration File	296
43.6.2 Resetting to the Factory Default	297

Chapter 44

Configuration Mode Commands 299

44.1 Enabling IGMP Snooping	299
44.2 Configure IGMP Filter	300
44.3 Enabling STP	301
44.4 no Command Examples	303
44.4.1 Disable Commands	303
44.4.2 Resetting Commands	303
44.4.3 Re-enable commands	303
44.4.4 Other Examples of no Commands	304
44.4.4.1 no trunk	304

44.4.4.2 no port-access-authenticator	305
44.4.4.3 no ssh	305
44.5 Static Route Commands	306
44.6 Enabling MAC Filtering	307
44.7 Enabling Trunking	308
44.8 Enabling Port Authentication	308
44.8.1 RADIUS Server Settings	308
44.8.2 Port Authentication Settings	309

Chapter 45

Interface Commands..... 311

45.1 Overview	311
45.2 Interface Command Examples	311
45.2.1 interface port-channel	311
45.2.2 bpdu-control	311
45.2.3 broadcast-limit	312
45.2.4 bandwidth-limit	312
45.2.5 mirror	313
45.2.6 gvrp	314
45.2.7 ingress-check	314
45.2.8 frame-type	315
45.2.9 weight	315
45.2.10 egress set	316
45.2.11 qos priority	316
45.2.12 name	317
45.2.13 speed-duplex	317
45.2.14 test	317
45.3 Interface no Command Examples	318
45.3.1 no bandwidth-limit	318

Chapter 46

IEEE 802.1Q Tagged VLAN Commands 319

46.1 Configuring Tagged VLAN	319
46.2 Global VLAN1Q Tagged VLAN Configuration Commands	320
46.2.1 GARP Status	320
46.2.2 GARP Timer	320
46.2.3 GVRP Timer	321
46.2.4 Enable GVRP	321
46.2.5 Disable GVRP	321
46.3 Port VLAN Commands	321
46.3.1 Set Port VID	322
46.3.2 Set Acceptable Frame Type	322
46.3.3 Enable or Disable Port GVRP	322

46.3.4 Modify Static VLAN	323
46.3.4.1 Modify a Static VLAN Table Example	323
46.3.4.2 Forwarding Process Example	323
46.3.5 Delete VLAN ID	324
46.4 Enable VLAN	324
46.5 Disable VLAN	325
46.6 Show VLAN Setting	325
Chapter 47	
Multicast VLAN Registration Commands	327
47.1 Overview	327
47.2 Create Multicast VLAN	327
Chapter 48	
Routing Domain Command Examples	329
48.0.1 interface route-domain	329
Chapter 49	
Troubleshooting	331
49.1 Problems Starting Up the Switch	331
49.2 Problems Accessing the Switch	331
49.2.1 Pop-up Windows, JavaScripts and Java Permissions	332
49.2.1.1 Internet Explorer Pop-up Blockers	332
49.2.1.2 JavaScripts	335
49.2.1.3 Java Permissions	337
49.3 Problems with the Password	339
Appendix A	
Product Specifications	341
Appendix B	
IP Addresses and Subnetting	347
Index	355

List of Figures

Figure 1 Backbone Application	32
Figure 2 Bridging Application	32
Figure 3 High Performance Switched Workgroup Application	33
Figure 4 Shared Server Using VLAN Example	34
Figure 5 Attaching Rubber Feet	35
Figure 6 Attaching the Mounting Brackets	36
Figure 7 Mounting the Switch on a Rack	37
Figure 8 Front Panel: GS-4024	39
Figure 9 Front Panel: GS-4012F	39
Figure 10 Transceiver Installation Example	42
Figure 11 Installed Transceiver	42
Figure 12 Opening the Transceiver's Latch Example	42
Figure 13 Transceiver Removal Example	43
Figure 14 Rear Panel: GS-4012F	43
Figure 15 Rear Panel: GS-4024	43
Figure 16 Rear Panel: GS-4012F (DC Model)	43
Figure 17 Rear Panel: GS-4024 (DC Model)	43
Figure 18 Web Configurator: Login	47
Figure 19 Web Configurator Home Screen (Status)	48
Figure 20 Change Administrator Login Password	53
Figure 21 Resetting the Switch: Via the Console Port	55
Figure 22 Web Configurator: Logout Screen	55
Figure 23 Initial Setup Network Example: IP Interface	57
Figure 24 Initial Setup Network Example: VLAN	59
Figure 25 Initial Setup Network Example: Port VID	60
Figure 26 Status	63
Figure 27 Status: Port Details	65
Figure 28 System Info	70
Figure 29 General Setup	72
Figure 30 Switch Setup	74
Figure 31 IP Setup	76
Figure 32 Port Setup	78
Figure 33 Port VLAN Trunking	83
Figure 34 Switch Setup: Select VLAN Type	84
Figure 35 VLAN: VLAN Status	84
Figure 36 Static VLAN Details	85
Figure 37 VLAN: Static VLAN	86
Figure 38 VLAN: VLAN Port Setting	87

Figure 39 Port Based VLAN Setup (All Connected)	90
Figure 40 Port Based VLAN Setup (Port Isolation)	91
Figure 41 Static MAC Forwarding	94
Figure 42 Filtering	95
Figure 43 MRSTP Network Example	99
Figure 44 Spanning Tree Protocol RSTP and MRSTP	100
Figure 45 RSTP: Configuration	101
Figure 46 Rapid Spanning Tree Protocol: Status	103
Figure 47 MRSTP: Configuration	104
Figure 48 MRSTP: Status	106
Figure 49 Bandwidth Control	108
Figure 50 Broadcast Storm Control	110
Figure 51 Mirroring	112
Figure 52 Link Aggregation Control Protocol Status	115
Figure 53 Link Aggregation Control Protocol: Configuration	116
Figure 54 RADIUS Server	119
Figure 55 Port Authentication	121
Figure 56 Port Authentication: RADIUS	121
Figure 57 Port Authentication: 802.1x	122
Figure 58 Port Security	126
Figure 59 Classifier	130
Figure 60 Classifier: Summary Table	132
Figure 61 Classifier: Example	134
Figure 62 Policy	137
Figure 63 Policy: Summary Table	139
Figure 64 Policy Example	141
Figure 65 Queuing Method	144
Figure 66 VLAN Stacking Example	148
Figure 67 VLAN Stacking	150
Figure 68 Multicast: Status	154
Figure 69 Multicast: Setting	155
Figure 70 Multicast: Setting: IGMP Filtering Profile	157
Figure 71 MVR Network Example	158
Figure 72 MVR Multicast Television Example	159
Figure 73 Multicast: Setting: MVR	160
Figure 74 MVR: Group Configuration	162
Figure 75 MVR Configuration Example	163
Figure 76 MVR Configuration Example	163
Figure 77 MVR Group Configuration Example	164
Figure 78 MVR Group Configuration Example	164
Figure 79 Static Routing	165
Figure 80 RIP	168
Figure 81 OSPF Network Example	170

Figure 82 OSPF Router Election Example	171
Figure 83 OSPF Status	172
Figure 84 OSPF Configuration: Area Setup	175
Figure 85 OSPF Configuration: Summary Table	176
Figure 86 OSPF Interface	177
Figure 87 OSPF Virtual Link	179
Figure 88 IGMP	181
Figure 89 How DVMRP Works	184
Figure 90 DVMRP	184
Figure 91 DVMRP: IGMP/RIP Not Set Error	185
Figure 92 DVMRP: Unable to Disable IGMP Error	185
Figure 93 DVMRP: Duplicate VID Error Message	186
Figure 94 IP Multicast	187
Figure 95 DiffServ: Differentiated Service Field	189
Figure 96 DiffServ Network Example	190
Figure 97 DiffServ	190
Figure 98 DiffServ: DSCP Setting	192
Figure 99 DHCP: DHCP Server Status	194
Figure 100 DHCP: Server	195
Figure 101 DHCP Server Network Example	196
Figure 102 DHCP Server Configuration Example	196
Figure 103 DHCP: Relay	197
Figure 104 DHCP Relay Network Example	198
Figure 105 DHCP Relay Configuration Example	198
Figure 106 VRRP: Example 1	200
Figure 107 VRRP Status	201
Figure 108 VRRP Configuration: IP Interface	202
Figure 109 VRRP Configuration: VRRP Parameters	204
Figure 110 VRRP Configuration: Summary	205
Figure 111 VRRP Configuration Example: One Virtual Router Network	206
Figure 112 VRRP Example 1: VRRP Parameter Settings on Switch A	206
Figure 113 VRRP Example 1: VRRP Parameter Settings on Switch B	206
Figure 114 VRRP Example 1: VRRP Status on Switch A	207
Figure 115 VRRP Example 1: VRRP Status on Switch B	207
Figure 116 VRRP Configuration Example: Two Virtual Router Network	207
Figure 117 VRRP Example 2: VRRP Parameter Settings for VR2 on Switch A ...	208
Figure 118 VRRP Example 2: VRRP Parameter Settings for VR2 on Switch B ...	208
Figure 119 VRRP Example 2: VRRP Status on Switch A	208
Figure 120 VRRP Example 2: VRRP Status on Switch B	208
Figure 121 Maintenance	209
Figure 122 Load Factory Default: Start	210
Figure 123 Reboot System: Confirmation	211
Figure 124 Firmware Upgrade	211

Figure 125 Restore Configuration	212
Figure 126 Backup Configuration	212
Figure 127 Access Control	215
Figure 128 SNMP Management Model	216
Figure 129 Access Control: SNMP	218
Figure 130 Access Control: Logins	219
Figure 131 SSH Communication Example	220
Figure 132 How SSH Works	221
Figure 133 HTTPS Implementation	222
Figure 134 Security Alert Dialog Box (Internet Explorer)	223
Figure 135 Security Certificate 1 (Netscape)	224
Figure 136 Security Certificate 2 (Netscape)	224
Figure 137 Example: Lock Denoting a Secure Connection	225
Figure 138 Access Control: Service Access Control	226
Figure 139 Access Control: Remote Management	227
Figure 140 Diagnostic	229
Figure 141 Syslog	232
Figure 142 Syslog: Server Setup	233
Figure 143 Clustering Application Example	236
Figure 144 Cluster Management: Status	237
Figure 145 Cluster Management: Cluster Member Web Configurator Screen	238
Figure 146 Example: Uploading Firmware to a Cluster Member Switch	239
Figure 147 Clustering Management Configuration	240
Figure 148 MAC Table Flowchart	243
Figure 149 MAC Table	244
Figure 150 IP Table Flowchart	245
Figure 151 IP Table	246
Figure 152 ARP Table	248
Figure 153 Routing Table Status	249
Figure 154 Configure Clone	251
Figure 155 no port-access-authenticator Command Example	305
Figure 156 Pop-up Blocker	332
Figure 157 Internet Options	333
Figure 158 Internet Options	334
Figure 159 Pop-up Blocker Settings	335
Figure 160 Internet Options	336
Figure 161 Security Settings - Java Scripting	337
Figure 162 Security Settings - Java	338
Figure 163 Java (Sun)	339

List of Tables

Table 1 Front Panel	39
Table 2 LEDs	44
Table 3 Navigation Panel Sub-links Overview	49
Table 4 Web Configurator Screen Sub-links Details	50
Table 5 Navigation Panel Links	50
Table 6 Status	63
Table 7 Status: Port Details	65
Table 8 System Info	70
Table 9 General Setup	72
Table 10 Switch Setup	74
Table 11 IP Setup	77
Table 12 Port Setup	78
Table 13 IEEE 802.1Q VLAN Terminology	82
Table 14 VLAN: VLAN Status	84
Table 15 Static VLAN Details	85
Table 16 VLAN: Static VLAN	86
Table 17 VLAN: VLAN Port Setting	88
Table 18 Port Based VLAN Setup	92
Table 19 Static MAC Forwarding	94
Table 20 Filtering	95
Table 21 STP Path Costs	97
Table 22 STP Port States	98
Table 23 Spanning Tree Protocol: Status	100
Table 24 RSTP: Configuration	101
Table 25 Rapid Spanning Tree Protocol: Status	103
Table 26 MRSTP: Configuration	104
Table 27 Spanning Tree Protocol: Status	106
Table 28 Bandwidth Control	108
Table 29 Broadcast Storm Control	110
Table 30 Mirroring	112
Table 31 Link Aggregation ID: Local Switch	114
Table 32 Link Aggregation ID: Peer Switch	114
Table 33 Link Aggregation Control Protocol Status	115
Table 34 Link Aggregation Control Protocol: Configuration	116
Table 35 Supported VSA	120
Table 36 Supported Tunnel Protocol Attribute	120
Table 37 Port Authentication: RADIUS	121
Table 38 Port Authentication: 802.1x	122

Table 39 Port Security	126
Table 40 Classifier	130
Table 41 Classifier: Summary Table	132
Table 42 Common Ethernet Types and Protocol Number	132
Table 43 Common IP Ports	133
Table 44 Policy	137
Table 45 Policy: Summary Table	139
Table 46 Queuing Method	144
Table 47 VLAN Tag Format	148
Table 48 Single and Double Tagged 802.1Q Frame Format	149
Table 49 802.1Q Frame	149
Table 50 VLAN Stacking	150
Table 51 Multicast Status	154
Table 52 Multicast Setting	155
Table 53 Multicast: IGMP Filtering Profile	157
Table 54 MVR	160
Table 55 MVR: Group Configuration	162
Table 56 Static Routing	165
Table 57 RIP	168
Table 58 OSPF vs. RIP	169
Table 59 OSPF: Router Types	169
Table 60 OSPF Status	172
Table 61 OSPF Status: Common Output Fields	172
Table 62 OSPF Configuration: Activating and General Settings	174
Table 63 OSPF Configuration: Area Setup	175
Table 64 OSPF Configuration: Summary Table	176
Table 65 OSPF Interface	177
Table 66 OSPF Virtual-Link	179
Table 67 IGMP	181
Table 68 DVMRP	185
Table 69 DVMRP: Default Timer Values	186
Table 70 IP Multicast	188
Table 71 DiffServ	190
Table 72 Default DSCP-IEEE802.1p Mapping	191
Table 73 DiffServ: DSCP Setting	192
Table 74 DHCP: DHCP Server Status	194
Table 75 DHCP: Server	195
Table 76 DHCP: Relay	197
Table 77 VRRP Status	201
Table 78 VRRP Configuration: IP Interface	202
Table 79 VRRP Configuration: VRRP Parameters	204
Table 80 VRRP Configuring: VRRP Parameters	205
Table 81 Maintenance	209

Table 82 Filename Conventions	213
Table 83 Access Control Overview	215
Table 84 SNMP Commands	216
Table 85 SNMP Traps	217
Table 86 Access Control: SNMP	218
Table 87 Access Control: Logins	219
Table 88 Access Control: Service Access Control	226
Table 89 Access Control: Remote Management	227
Table 90 Diagnostic	229
Table 91 Syslog Severity Levels	231
Table 92 Syslog	232
Table 93 Syslog: Server Setup	233
Table 94 ZyXEL Clustering Management Specifications	235
Table 95 Cluster Management: Status	237
Table 96 FTP Upload to Cluster Member Example	239
Table 97 Clustering Management Configuration	240
Table 98 MAC Table	244
Table 99 IP Table	246
Table 100 ARP Table	248
Table 101 Routing Table Status	249
Table 102 Configure Clone	251
Table 103 Command Interpreter Mode Summary	256
Table 104 Command Summary: User Mode	260
Table 105 Command Summary: Enable Mode	261
Table 106 Command Summary: Configuration Mode	267
Table 107 interface port-channel Commands	283
Table 108 interface route-domain Commands	287
Table 109 Command Summary: config-vlan Commands	288
Table 110 Command Summary: mvr Commands	289
Table 111 Troubleshooting the Start-Up of Your Switch	331
Table 112 Troubleshooting Accessing the Switch	331
Table 113 Troubleshooting the Password	339
Table 114 Firmware Features	341
Table 115 General Product Specifications	343
Table 116 Management Specifications	344
Table 117 Physical and Environmental Specifications	345
Table 118 Power Specifications	345
Table 119 Classes of IP Addresses	348
Table 120 Allowed IP Address Range By Class	348
Table 121 "Natural" Masks	349
Table 122 Alternative Subnet Mask Notation	349
Table 123 Two Subnets Example	350
Table 124 Subnet 1	350

Table 125 Subnet 2	351
Table 126 Subnet 1	351
Table 127 Subnet 2	352
Table 128 Subnet 3	352
Table 129 Subnet 4	352
Table 130 Eight Subnets	353
Table 131 Class C Subnet Planning	353
Table 132 Class B Subnet Planning	354

Preface

Congratulations on your purchase of the Gigabit Switch.

This preface introduces you to the Gigabit Switch and discusses the conventions of this User's Guide. It also provides information on other related documentation.

About This User's Guide

This manual is designed to guide you through the installation and configuration of your switch for its various applications.

Related Documentation

- Web Configurator Online Help

Embedded web help for descriptions of individual screens and supplementary information.









- ZyXEL Web Site

Please refer to www.zyxel.com for additional support documentation.

Syntax Conventions

- “Enter” means for you to type one or more characters. “Select” or “Choose” means for you to use one of the predefined choices.
- Command and arrow keys are enclosed in square brackets. [ENTER] means the Enter, or carriage return key; [ESC] means the Escape key and [SPACE BAR] means the Space Bar.
- Mouse action sequences are denoted using a comma. For example, “In Windows, click **Start, Settings** and then **Control Panel**” means first click the **Start** button, then point your mouse pointer to **Settings** and then click **Control Panel**.
- For brevity's sake, we will use “e.g.,” as a shorthand for “for instance”, and “i.e.,” for “that is” or “in other words” throughout this manual.
- The GS-4012F/4024 Ethernet Switch may be referred to as “the switch”, “the router” or “the device” in this User's Guide.

Graphics Icons Key

the switch 	Computer 	Server 
Computer 	DSLAM 	Router 
Central Office/ ISP 	Internet 	Hub/Switch 

User Guide Feedback

Help us help you. E-mail all User Guide-related comments, questions or suggestions for improvement to techwriters@zyxel.com.tw or send regular mail to The Technical Writing Team, ZyXEL Communications Corp., 6 Innovation Road II, Science-Based Industrial Park, Hsinchu, 300, Taiwan. Thank you.

CHAPTER 1

Getting to Know Your Switch

This chapter introduces the main features and applications of the switch.

1.1 Introduction

Your switch is a stand-alone layer-3 Gigabit Ethernet switch. By integrating router functions, the switch performs wire-speed layer-3 routing in addition to layer-2 switching.

The GS-4024 is a stand-alone layer 3 Ethernet switch with 20 Gigabit Ethernet ports and 4 GbE dual personality interfaces for uplink. A dual personality interface includes one Gigabit port and one slot for mini-GBIC transceiver (SFP module) with one port active at a time.

The GS-4012F comes with with 8 min-GBIC slots and 4 GbE dual personality interfaces for uplink. There are two GS-4012F models. The GS-4012F DC model requires DC power supply input of -48 VDC to -60 VDC, 1.5A Max no tolerance. The GS-4012F AC model requires 100~240VAC, 1.6A power.

With its built-in web configurator, managing and configuring the switch is easy. In addition, the switch can also be managed via Telnet, any terminal emulator program on the console port, or third-party SNMP management.

See [Appendix A on page 341](#) for a full list of software features available on the switch.

1.1.1 Backbone Application

The switch is an ideal solution for small networks where rapid growth can be expected in the near future. The switch can be used standalone for a group of heavy traffic users. You can connect computers and servers directly to the switch's port or connect other switches to the switch.

In this example, all computers can share high-speed applications on the server. To expand the network, simply add more networking devices such as switches, routers, computers, print servers etc.

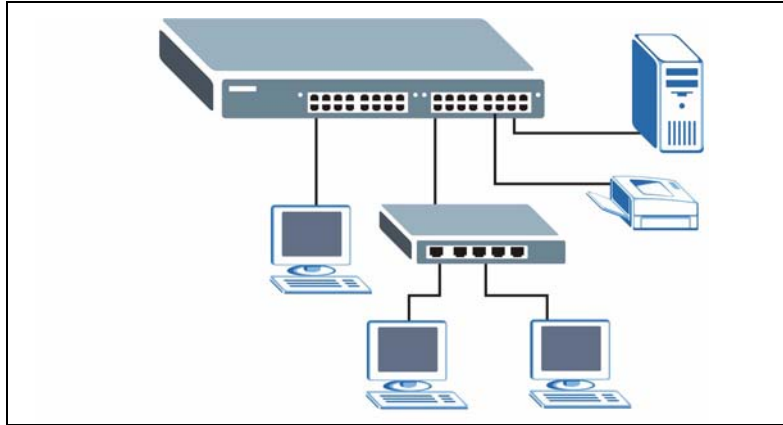
Figure 1 Backbone Application

1.1.2 Bridging Example

In this example application the switch connects different company departments (**RD** and **Sales**) to the corporate backbone. It can alleviate bandwidth contention and eliminate server and network bottlenecks. All users that need high bandwidth can connect to high-speed department servers via the switch. You can provide a super-fast uplink connection by using a Gigabit Ethernet/mini-GBIC port on the switch.

Moreover, the switch eases supervision and maintenance by allowing network managers to centralize multiple servers at a single location.

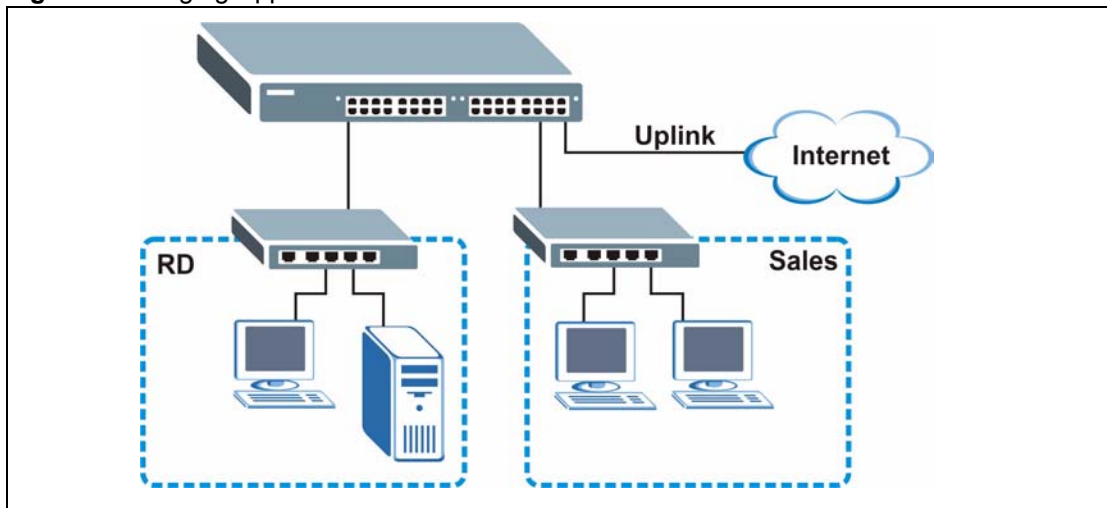
Figure 2 Bridging Application

1.1.3 High Performance Switching Example

The switch is ideal for connecting two networks that need high bandwidth. In the following example, use trunking to connect these two networks.

Switching to higher-speed LANs such as ATM (Asynchronous Transmission Mode) is not feasible for most people due to the expense of replacing all existing Ethernet cables and adapter cards, restructuring your network and complex maintenance. The switch can provide the same bandwidth as ATM at much lower cost while still being able to use existing adapters and switches. Moreover, the current LAN structure can be retained as all ports can freely communicate with each other.

Figure 3 High Performance Switched Workgroup Application

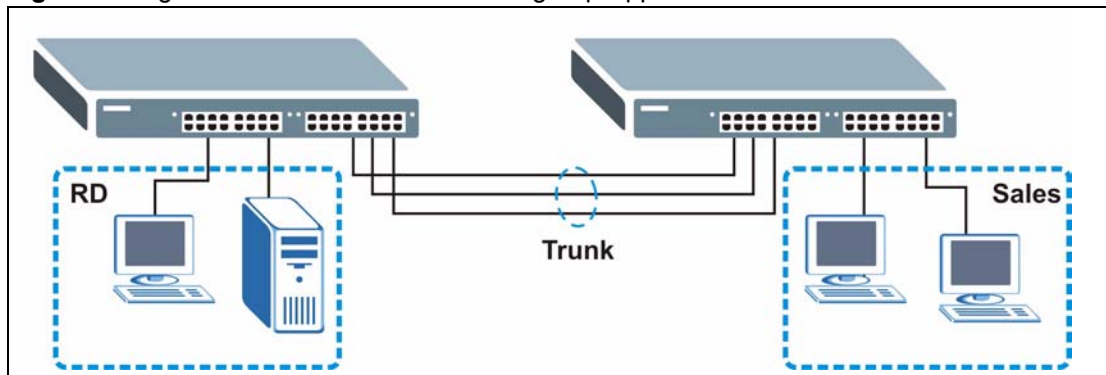

1.1.4 IEEE 802.1Q VLAN Application Examples

A VLAN (Virtual Local Area Network) allows a physical network to be partitioned into multiple logical networks. Stations on a logical network belong to one group. A station can belong to more than one group. With VLAN, a station cannot directly talk to or hear from stations that are not in the same group(s) unless such traffic first goes through a router.

For more information on VLANs, refer to [Chapter 8 on page 81](#).

1.1.4.1 Tag-based VLAN Example

Ports in the same VLAN group share the same frame broadcast domain thus increase network performance through reduced broadcast traffic. VLAN groups can be modified at any time by adding, moving or changing ports without any re-cabling.

Shared resources such as a server can be used by all ports in the same VLAN as the server. In the following figure only ports that need access to the server need to be part of VLAN 1. Ports can belong to other VLAN groups too.

Figure 4 Shared Server Using VLAN Example

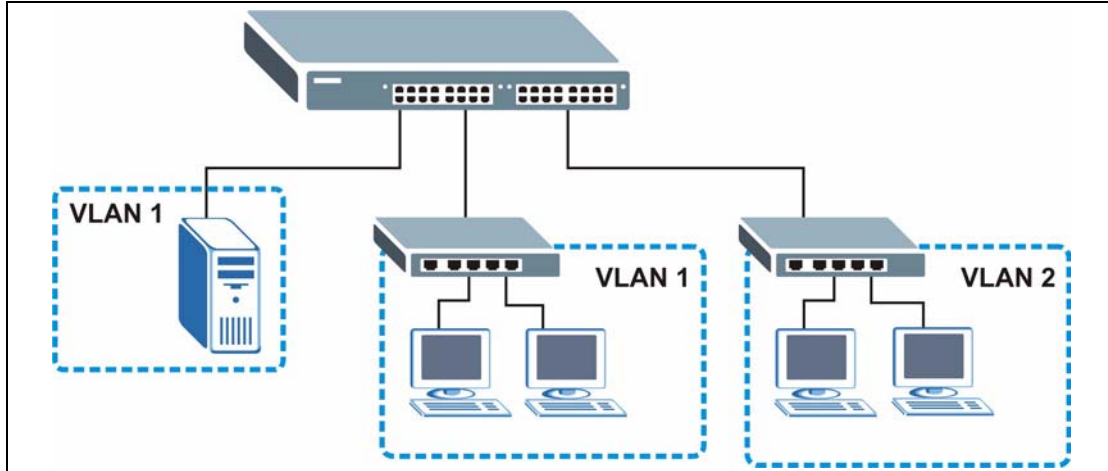

CHAPTER 2

Hardware Installation and Connection

This chapter shows you how to install the hardware and make port connections.

Note: Example graphics are shown.

2.1 Freestanding Installation

- 1 Make sure the switch is clean and dry.
- 2 Set the switch on a smooth, level surface strong enough to support the weight of the switch and the connected cables. Make sure there is a power outlet nearby.
- 3 Make sure there is enough clearance around the switch to allow air circulation and the attachment of cables and the power cord.
- 4 Remove the adhesive backing from the rubber feet.
- 5 Attach the rubber feet to each corner on the bottom of the switch. These rubber feet help protect the switch from shock or vibration and ensure space between devices when stacking.

Figure 5 Attaching Rubber Feet

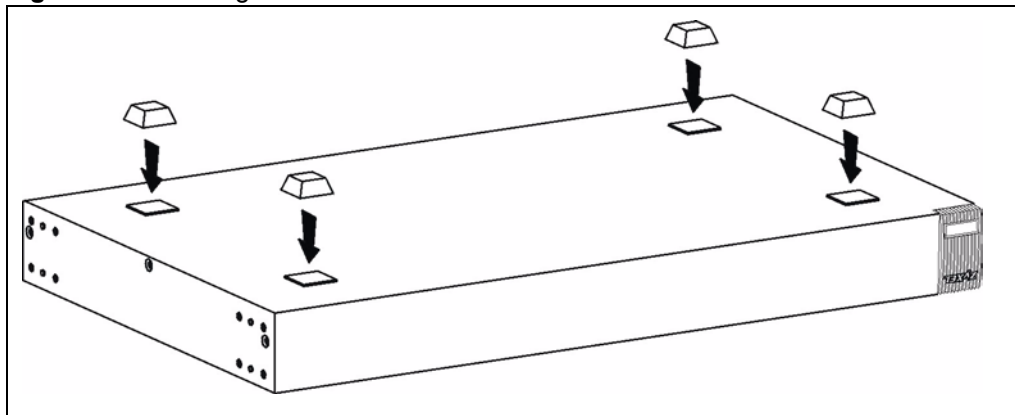

Note: Do NOT block the ventilation holes. Leave space between devices when stacking.

For proper ventilation, allow at least 4 inches (10 cm) of clearance at the front and 3.4 inches (8 cm) at the back of the switch. This is especially important for enclosed rack installations.

2.2 Mounting the Switch on a Rack

This section lists the rack mounting requirements and precautions and describes the installation steps.

2.2.1 Rack-mounted Installation Requirements

- Two mounting brackets.
- Eight M3 flat head screws and a #2 Philips screwdriver.
- Four M5 flat head screws and a #2 Philips screwdriver.

Note: Failure to use the proper screws may damage the unit.

2.2.1.1 Precautions

- Make sure the rack will safely support the combined weight of all the equipment it contains.
- Make sure the position of the switch does not make the rack unstable or top-heavy. Take all necessary precautions to anchor the rack securely before installing the unit.

2.2.2 Attaching the Mounting Brackets to the Switch

- 1 Position a mounting bracket on one side of the switch, lining up the four screw holes on the bracket with the screw holes on the side of the switch.

Figure 6 Attaching the Mounting Brackets

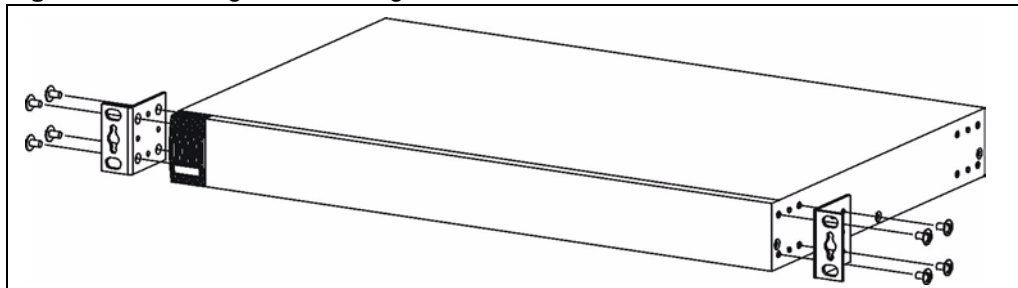

- 2 Using a #2 Philips screwdriver, install the M3 flat head screws through the mounting bracket holes into the switch.
- 3 Repeat steps 1 and 2 to install the second mounting bracket on the other side of the switch.
- 4 You may now mount the switch on a rack. Proceed to the next section.

2.2.3 Mounting the Switch on a Rack

- 1 Position a mounting bracket (that is already attached to the switch) on one side of the rack, lining up the two screw holes on the bracket with the screw holes on the side of the rack.

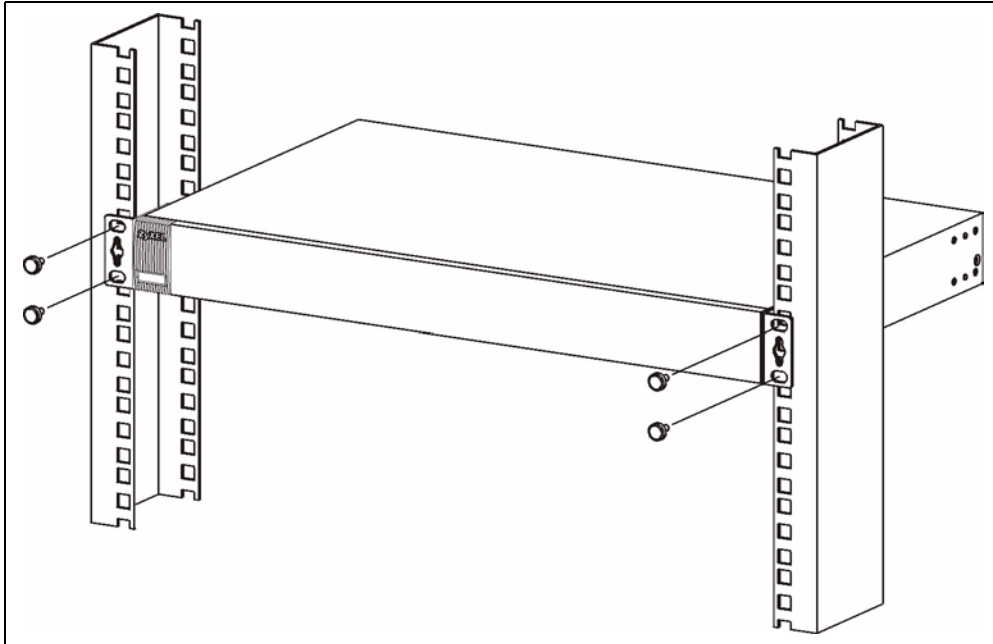
Figure 7 Mounting the Switch on a Rack

- 2** Using a #2 Philips screwdriver, install the M5 flat head screws through the mounting bracket holes into the rack.
- 3** Repeat steps [1](#) and [2](#) to attach the second mounting bracket on the other side of the rack.

CHAPTER 3

Hardware Overview

This chapter describes the front panel and rear panel of the switch and shows you how to make the hardware connections.

3.1 Front Panel Connection

The figure below shows the front panel of the switch.

Figure 8 Front Panel: GS-4024

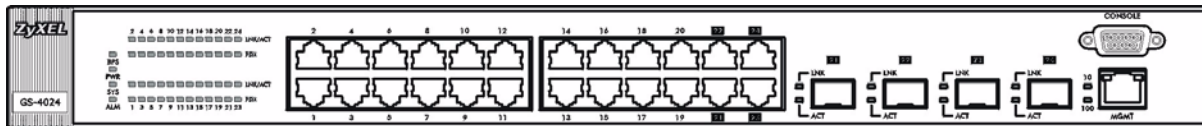
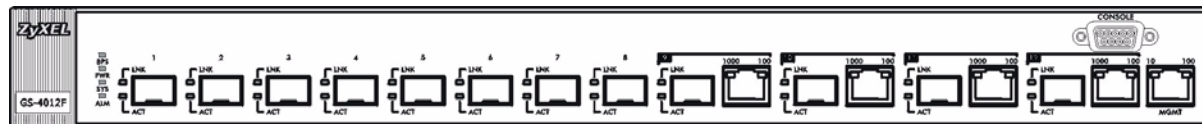

Figure 9 Front Panel: GS-4012F



The following table describes the port labels on the front panel.

Table 1 Front Panel

PORT	DESCRIPTION
MGMT	Connect to a computer using an RJ-45 Ethernet cable for local configuration of the switch.
CONSOLE	Only connect this port if you want to configure the switch using the command line interface (CLI) via the console port.
GS-4024 Model	
20 100/1000 Mbps RJ-45 Gigabit Ethernet Ports	Connect these ports to a computer, a hub, an Ethernet switch or router.

Table 1 Front Panel (continued)

PORT	DESCRIPTION
Four Dual Personality Interfaces	Each interface has one 1000 Base-T copper RJ-45 port and one Small Form-Factor Pluggable (SFP) fiber port, with one port active at a time.
	<ul style="list-style-type: none"> 4 100/1000 Mbps RJ-45 Gigabit Ports: Connect these Gigabit Ethernet ports to high-bandwidth backbone network Ethernet switches.
	<ul style="list-style-type: none"> 4 Mini-GBIC Ports: Use mini-GBIC transceivers in these slots for fiber-optic connections to backbone Ethernet switches (see Section 3.1.3 on page 41 for instructions).
GS-4012F Model	
8 Mini-GBIC Slots	Use mini-GBIC transceivers in these slots for fiber-optic connections to backbone Ethernet switches (see Section 3.1.3 on page 41 for instructions).
Four Dual Personality Interfaces	Each interface has one 1000 Base-T copper RJ-45 port and one Small Form-Factor Pluggable (SFP) fiber port, with one port active at a time.
	<ul style="list-style-type: none"> 4 100/1000 Mbps RJ-45 Gigabit Ports: Connect these Gigabit Ethernet ports to high-bandwidth backbone network Ethernet switches.
	<ul style="list-style-type: none"> 4 Mini-GBIC Ports: Use mini-GBIC transceivers in these slots for fiber-optic connections to backbone Ethernet switches (see Section 3.1.3 on page 41 for instructions).

3.1.1 Console Port

For local management, you can use a computer with terminal emulation software configured to the following parameters:

- VT100 terminal emulation
- 9600 bps
- No parity, 8 data bits, 1 stop bit
- No flow control

Connect the male 9-pin end of the console cable to the console port of the switch. Connect the female end to a serial port (COM1, COM2 or other COM port) of your computer.

3.1.2 Gigabit Ethernet Ports

The switch has 10/100/1000 Mbps auto-negotiating, auto-crossover Gigabit Ethernet ports. In 10/100/1000 Mbps Gigabit Ethernet, the speed can be 10 Mbps, 100 Mbps or 1000 Mbps and the duplex mode can be half duplex (for 100 Mbps) or full duplex.

An auto-negotiating port can detect and adjust to the optimum Ethernet speed and duplex mode (full duplex or half duplex) of the connected device.

An auto-crossover (auto-MDI/MDI-X) port automatically works with a straight-through or crossover Ethernet cable.

3.1.2.1 Default Ethernet Settings

The factory default negotiation settings for the Ethernet ports on the switch are:

- Speed: Auto
- Duplex: Auto
- Flow control: on

3.1.3 SFP Slots

The switch comes with SFP (Small Form-factor Pluggable) slots for mini-GBIC (Gigabit Interface Converter) transceivers. A transceiver is a single unit that houses a transmitter and a receiver. The switch does not come with transceivers. You must use transceivers that comply with the SFP transceiver MultiSource Agreement (MSA). See the SFF committee's INF-8074i specification Rev 1.0 for details.

SFP transceivers can be standalone interfaces or part of a dual personality interface. Each dual personality interface has one 1000 Base-T copper RJ-45 port and one Small Form-Factor Pluggable (SFP) fiber slot for mini-GBIC transceivers, with one port active at a time. The mini-GBIC ports have priority over the Gigabit ports. This means that if a mini-GBIC port and the corresponding Gigabit port are connected at the same time, the Gigabit port will be disabled.

You can change transceivers while the switch is operating. You can use different transceivers to connect to Ethernet switches with different types of fiber-optic connectors.

- Type: SFP connection interface
- Connection speed: 1 Gigabit per second (Gbps)

Note: To avoid possible eye injury, do NOT look into an operating fiber-optic module's connectors.

3.1.3.1 Transceiver Installation

Use the following steps to install a mini-GBIC transceiver (SFP module).

- 1 Insert the transceiver into the slot with the exposed section of PCB board facing down.

Figure 10 Transceiver Installation Example

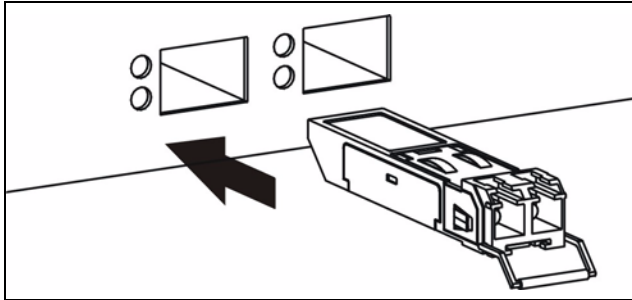

- 2** Press the transceiver firmly until it clicks into place.
- 3** The switch automatically detects the installed transceiver. Check the LEDs to verify that it is functioning properly.

Figure 11 Installed Transceiver

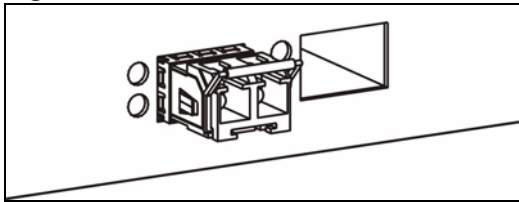

3.1.3.2 Transceiver Removal

Use the following steps to remove a mini-GBIC transceiver (SFP module).

- 1** Open the transceiver's latch (latch styles vary).

Figure 12 Opening the Transceiver's Latch Example

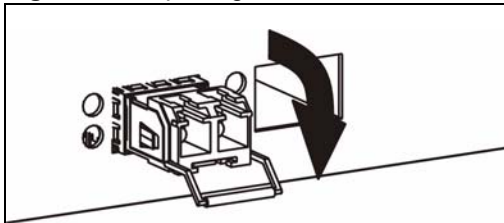

- 2** Pull the transceiver out of the slot.

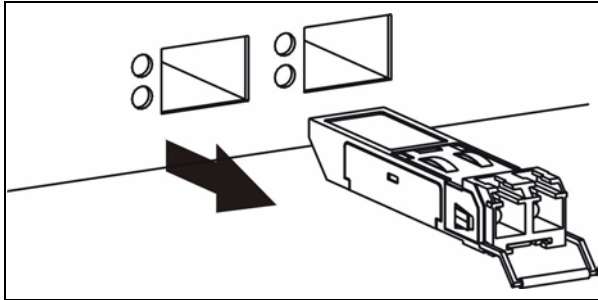
Figure 13 Transceiver Removal Example

3.2 Rear Panel

The following figures show the rear panels of the AC and DC power input model switches. The rear panel contains a connector for backup power supply (BPS) and the power receptacle. For the DC power input model, it also contains the power switch.

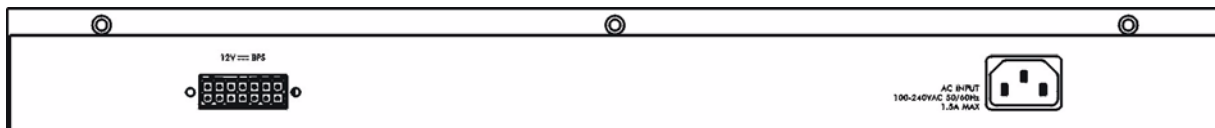
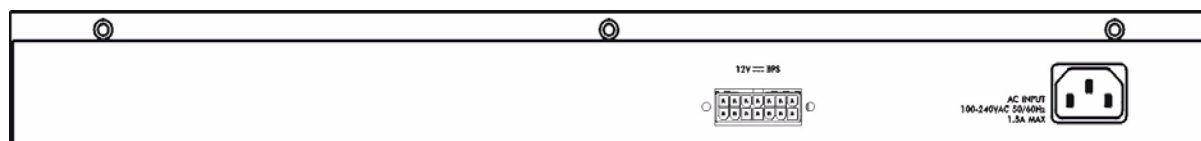
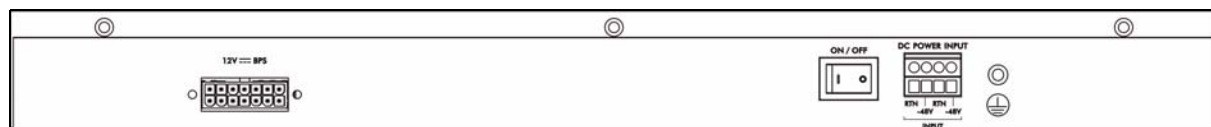
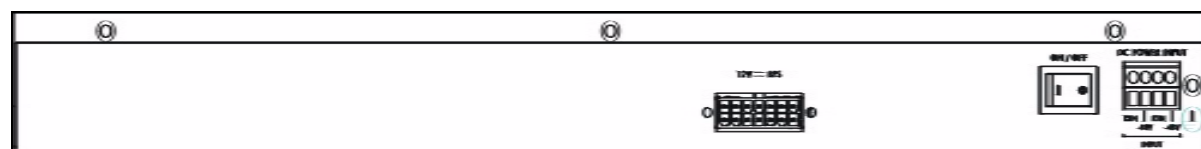
Figure 14 Rear Panel: GS-4012F**Figure 15** Rear Panel: GS-4024**Figure 16** Rear Panel: GS-4012F (DC Model)**Figure 17** Rear Panel: GS-4024 (DC Model)

3.2.1 Power Connector

Make sure you are using the correct power source as shown on the panel.

To connect the power to the GS-4012F/4024 AC unit, insert the female end of power cord to the power receptacle on the rear panel. Connect the other end of the supplied power cord to a 100~240V AC, 1.5A power outlet. Make sure that no objects obstruct the airflow of the fans.

The GS-4012F DC unit requires DC power supply input of -48V DC to -60V DC, 1.6A Max no tolerance and the GS-4012F DC unit requires DC power supply input of -48V DC to -60V DC, 2.2A Max no tolerance. To connect the power to the DC units, insert one end of the supplied power cord to the power receptacle on the rear panel and the other end to a power outlet. Make sure that no objects obstruct the airflow of the fans.

3.2.2 External Backup Power Supply Connector

The backup power supply constantly monitors the status of the internal power supply. The backup power supply automatically provides power to the switch in the event of a power failure. Once the switch receives power from the backup power supply, it will not automatically switch back to using the internal power supply even when the power is resumed.

3.3 LEDs

The following table describes the LEDs.

Table 2 LEDs

LED	COLOR	STATUS	DESCRIPTION
BPS	Green	Blinking	The system is receiving power from the backup power supply.
		On	The backup power supply is connected and active.
		Off	The backup power supply is not ready or not active.
PWR	Green	On	The system is turned on.
		Off	The system is off.
SYS	Green	Blinking	The system is rebooting and performing self-diagnostic tests.
		On	The system is on and functioning properly.
		Off	The power is off or the system is not ready/malfunctioning.
ALM	Red	On	There is a hardware failure.
		Off	The system is functioning normally.
MGMT Port			
10	Green	On	The link to a 10 Mbps Ethernet network is up.
		Blinking	The port is sending or receiving data at 10 Mbps.
		Off	The link to a 10 Mbps Ethernet network is down.
100	Amber	On	The link to a 100 Mbps Ethernet network is up.
		Blinking	The port is sending or receiving data at 100 Mbps.
		Off	The link to a 100 Mbps Ethernet network is down.
GS-4024 Model			
Gigabit Ethernet Ports			

Table 2 LEDs (continued)

LED	COLOR	STATUS	DESCRIPTION
LNK/ACT	Green	On	The port has a successful 10/1000 Mbps connection.
	Amber	On	The port has a successful 100 Mbps connection.
		Blinking	The port is sending or receiving data.
		Off	The port is disconnected or the link failed.
FDX	Amber	On	The port is in full duplex mode.
		Off	The port is in half duplex mode or there is no connection.
Mini-GBIC (SFP) Slots			
LNK	Green	On	The port has a successful connection.
		Off	No Ethernet device is connected to this port.
ACT	Green	Blinking	The port is sending or receiving data.
		Off	The port is not sending or receiving data or there is no connection.
GS-4012F Model			
Mini-GBIC (SFP) Slots (Standalone and Part of Dual Personality Interface)			
LNK	Green	On	The port has a successful connection.
		Off	No Ethernet device is connected to this port.
ACT	Green	Blinking	The port is sending or receiving data.
		Off	The port is not sending or receiving data or there is no connection.
Gigabit Ethernet Ports (Part of Dual Personality Interface)			
1000	Green	Blinking	The port is sending/receiving data.
		On	The link to a 10/1000 Mbps Ethernet network is up.
		Off	The link to a 10/1000 Mbps Ethernet network is down.
100	Amber	Blinking	The port is sending/receiving data.
		On	The link to a 100 Mbps Ethernet network is up.
		Off	The link to a 100 Mbps Ethernet network is down.

CHAPTER 4

The Web Configurator

This section introduces the configuration and functions of the web configurator.

4.1 Introduction

The web configurator is an HTML-based management interface that allows easy switch setup and management via Internet browser. Use Internet Explorer 6.0 and later or Netscape Navigator 7.0 and later versions. The recommended screen resolution is 1024 by 768 pixels.

In order to use the web configurator you need to allow:

- Web browser pop-up windows from your device. Web pop-up blocking is enabled by default in Windows XP SP (Service Pack) 2.
- JavaScript (enabled by default).
- Java permissions (enabled by default).

4.2 System Login

- 1 Start your web browser.
- 2 Type “http://” and the IP address of the switch (for example, the default is 192.168.1.1) in the Location or Address field. Press [ENTER].
- 3 The login screen appears. The default username is **admin** and associated default password is **1234**. The date and time display as shown if you have not configured a time server nor manually entered a time and date in the **General Setup** screen.

Figure 18 Web Configurator: Login

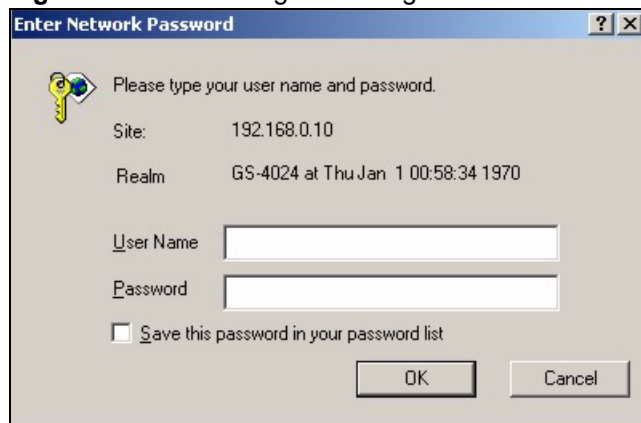

The screenshot shows a dialog box titled "Enter Network Password" with a question mark and close button in the title bar. The dialog contains the following elements:

- A key icon and the text: "Please type your user name and password."
- Site: 192.168.0.10
- Realm: GS-4024 at Thu Jan 1 00:58:34 1970
- Input fields for "User Name" and "Password".
- A checkbox labeled "Save this password in your password list" which is currently unchecked.
- "OK" and "Cancel" buttons at the bottom.

4 Click **OK** to view the first web configurator screen.

4.3 The Status Screen

The **Status** screen is the first screen that displays when you access the web configurator.

The following figure shows the navigating components of a web configurator screen.

Figure 19 Web Configurator Home Screen (Status)

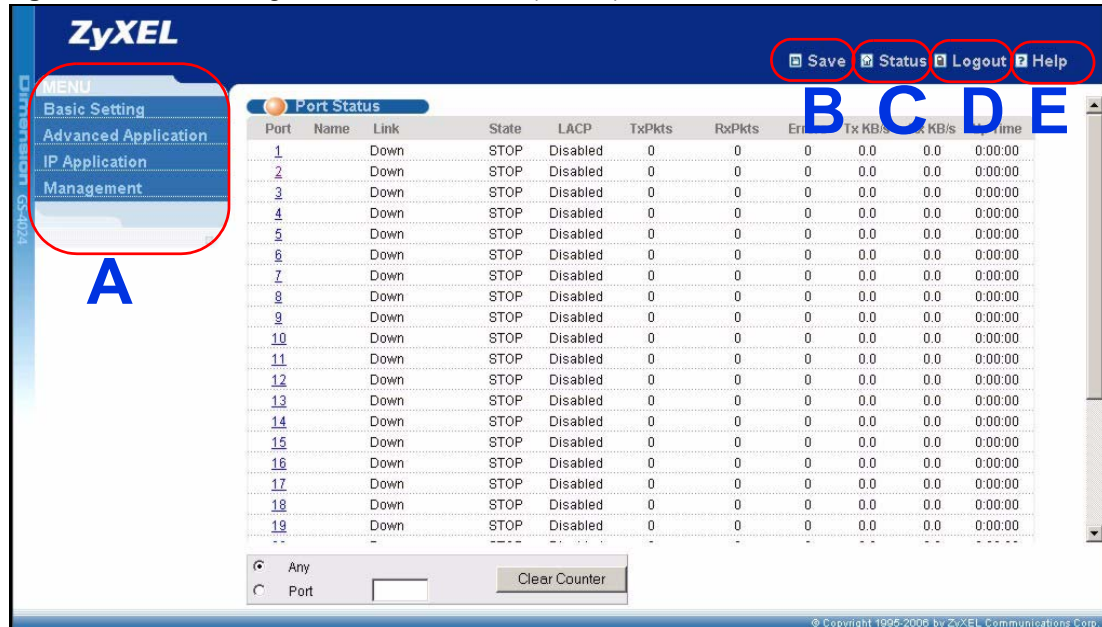

A - Click the menu items to open submenu links, and then click on a submenu link to open the screen in the main window.

B, C, D, E - These are quick links which allow you to perform certain tasks no matter which screen you are currently working in.

B - Click this link to save your configuration into the switch's nonvolatile memory. Nonvolatile memory is the configuration of your switch that stays the same even if the switch's power is turned off.



C - Click this link to go to the status page of the switch.

D - Click this link to logout of the web configurator.

E - Click this link to display web help pages. The help pages provide descriptions for all of the configuration screens.

In the navigation panel, click a main link to reveal a list of submenu links.

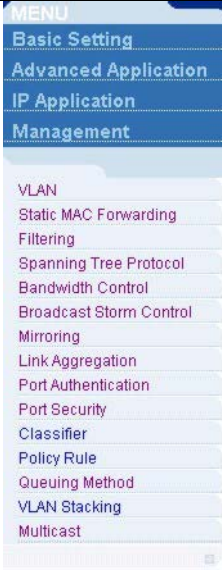
Table 3 Navigation Panel Sub-links Overview

BASIC SETTING	ADVANCED APPLICATION	IP APPLICATION	MANAGEMENT
			

The following table lists the various web configurator screens within the sub-links.

Table 4 Web Configurator Screen Sub-links Details

BASIC SETTING	ADVANCED APPLICATION	IP APPLICATION	MANAGEMENT
System Info	VLAN	Static Routing	Maintenance
General Setup	VLAN Status	RIP	Firmware Upgrade
Switch Setup	VLAN Port Setting	OSPF Status	Restore Configuration
IP Setup	Static VLAN	OSPF Configuration	Backup Configuration
Port Setup	Static MAC Forwarding	OSPF Interface	Load Factory Default
	Filtering	OSPF Virtual Link	Reboot System
	Spanning Tree Protocol	IGMP	Access Control
	Status	DVMRP	SNMP
	Spanning Tree	IP Multicast	Logins
	Protocol Configuration	DiffServ	Service Access Control
	Bandwidth Control	DSCP Setting	Remote Management
	Broadcast Storm Control	DHCP Server Status	Diagnostic
	Mirroring	DHCP Server	Syslog
	Link Aggregation	DHCP Relay	Syslog Setup
	Status	VRRP	Server Setup
	RSTP	Status	Cluster Management
	MRSTP	VRRP Configuration	Status
	Port Authentication		Configuration
	RADIUS		MAC Table
	802.1x		IP Table
	Port Security		ARP Table
	Classifier		Routing Table
	Policy Rule		Configure Clone
	Queuing Method		
	VLAN Stacking		
	Multicast		
	Setting		
	Status		
	IGMP Filtering Profile		
	MVR		
	Group Configuration		

The following table describes the links in the navigation panel.

Table 5 Navigation Panel Links

LINK	DESCRIPTION
Basic Settings	
System Info	This link takes you to a screen that displays general system and hardware monitoring information.
General Setup	This link takes you to a screen where you can configure general identification information about the switch.

Table 5 Navigation Panel Links (continued)

LINK	DESCRIPTION
Switch Setup	This link takes you to a screen where you can set up global switch parameters such as VLAN type, MAC address learning, IGMP snooping, GARP and priority queues.
IP Setup	This link takes you to a screen where you can configure the IP address, subnet mask (necessary for switch management) and DNS (domain name server) and set up to 64 IP routing domains.
Port Setup	This link takes you to screens where you can configure settings for individual switch ports.
Advanced Application	
VLAN	This link takes you to screens where you can configure port-based or 802.1Q VLAN (depending on what you configured in the Switch Setup menu).
Static MAC Forwarding	This link takes you to screens where you can configure static MAC addresses for a port. These static MAC addresses do not age out.
Filtering	This link takes you to a screen to set up filtering rules.
Spanning Tree Protocol	This link takes you to screens where you can configure the RSTP/MRSTP to prevent network loops.
Bandwidth Control	This link takes you to screens where you can cap the maximum bandwidth allowed from specified source(s) to specified destination(s).
Broadcast Storm Control	This link takes you to a screen to set up broadcast filters.
Mirroring	This link takes you to screens where you can copy traffic from one port or ports to another port in order that you can examine the traffic from the first port without interference
Link Aggregation	This link takes you to a screen where you can logically aggregate physical links to form one logical, higher-bandwidth link.
Port Authentication	This link takes you to a screen where you can configure RADIUS (Remote Authentication Dial-In User Service), a protocol for user authentication that allows you to use an external server to validate an unlimited number of users.
Port Security	This link takes you to a screen where you can activate MAC address learning and set the maximum number of MAC addresses to learn on a port.
Classifier	This link takes you to a screen where you can configure the switch to group packets based on the specified criteria.
Policy Rule	This link takes you to a screen where you can configure the switch to perform special treatment on the grouped packets.
Queuing Method	This link takes you to a screen where you can configure queuing with associated queue weights for each port.
VLAN Stacking	This link takes you to a screen where you can configure VLAN stacking.
Multicast	This link takes you to a screen where you can configure various multicast features and create multicast VLANs.
IP Application	
Static Route	This link takes you to screens where you can configure static routes. A static route defines how the switch should forward traffic by configuring the TCP/IP parameters manually.
RIP	This link takes you to a screen where you can configure the RIP (Routing Information Protocol) direction and versions.
OSPF	This link takes you to screens where you can view the OSPF status and configure OSPF settings.

Table 5 Navigation Panel Links (continued)

LINK	DESCRIPTION
IGMP	This link takes you to a screen where you can configure the IGMP settings.
DVMRP	This link takes you to a screen where you can configure the DVMRP (Distance Vector Multicast Routing Protocol) settings.
IP Multicast	This link takes you to a screen where you can configure the switch to remove VLAN tags from IP multicast packets on an out-going port.
DiffServ	This link takes you to screens where you can enable DiffServ, configure marking rules and set DSCP-to-IEEE802.1p mappings.
DHCP	This link takes you to a screen where you can configure the DHCP settings.
VRRP	This link takes you to screens where you can configure redundant virtual router for your network.
Management	
Maintenance	This link takes you to screens where you can perform firmware and configuration file maintenance as well as reboot the system.
Access Control	This link takes you to screens where you can change the system login password and configure SNMP and remote management.
Diagnostic	This link takes you to screens where you can view system logs and test port(s).
Syslog	This link takes you to screens where you can setup system logs and a system log server.
Cluster Management	This link takes you to a screen where you can configure clustering management and view its status.
MAC Table	This link takes you to a screen where you can view the MAC addresses (and types) of devices attached to what ports and VLAN IDs.
IP Table	This link takes you to a screen where you can view the IP addresses (and types) of devices attached to what ports and VLAN IDs.
ARP Table	This link takes you to a screen where you can view the MAC addresses – IP address resolution table.
Routing Table	This link takes you to a screen where you can view the routing table.
Configure Clone	This link takes you to a screen where you can copy attributes of one port to other ports.

4.3.1 Change Your Password

After you log in for the first time, it is recommended you change the default administrator password. Click **Management**, **Access Control** and then **Logins** to display the next screen.

Figure 20 Change Administrator Login Password

Logins [Access Control](#)

Administrator

Old Password

New Password

Retype to confirm

Please record your new password whenever you change it. The system will lock you out if you have forgotten your password.

Edit Logins

Login	User Name	Password	Retype to confirm
1	<input type="text"/>	<input type="text"/>	<input type="text"/>
2	<input type="text"/>	<input type="text"/>	<input type="text"/>
3	<input type="text"/>	<input type="text"/>	<input type="text"/>
4	<input type="text"/>	<input type="text"/>	<input type="text"/>

4.4 Saving Your Configuration

When you are done modifying the settings in a screen, click **Apply** to save your changes back to the run-time memory. Settings in the run-time memory are lost when the switch's power is turned off.

Click the **Save** link in the upper right hand corner of the web configurator to save your configuration to nonvolatile memory. Nonvolatile memory refers to the switch's storage that remains even if the switch's power is turned off.

Note: Use the **Save** link when you are done with a configuration session.

4.5 Switch Lockout

You could block yourself (and all others) from using in-band-management (managing through the data ports) if you do one of the following:

- 1 Delete the management VLAN (default is VLAN 1).
- 2 Delete all port-based VLANs with the CPU port as a member. The "CPU port" is the management port of the switch.
- 3 Filter all traffic to the CPU port.
- 4 Disable all ports.
- 5 Misconfigure the text configuration file.
- 6 Forget the password and/or IP address.
- 7 Prevent all services from accessing the switch.
- 8 Change a service port number but forget it.

Note: Be careful not to lock yourself and others out of the switch. If you do lock yourself out, try using out-of-band management (via the management port) to configure the switch.

4.6 Resetting the Switch

If you lock yourself (and others) from the switch or forget the administrator password, you will need to reload the factory-default configuration file or reset the switch back to the factory defaults.

4.6.1 Reload the Configuration File

Uploading the factory-default configuration file replaces the current configuration file with the factory-default configuration file. This means that you will lose all previous configurations and the speed of the console port will be reset to the default of 9600bps with 8 data bit, no parity, one stop bit and flow control set to none. The password will also be reset to “1234” and the IP address to 192.168.1.1.

To upload the configuration file, do the following:

- 1** Connect to the console port using a computer with terminal emulation software. See [Section 3.1.1 on page 40](#) for details.
- 2** Disconnect and reconnect the switch's power to begin a session. When you reconnect the switch's power, you will see the initial screen.
- 3** When you see the message “Press any key to enter Debug Mode within 3 seconds . . .” press any key to enter debug mode.
- 4** Type `atlc` after the “Enter Debug Mode” message.
- 5** Wait for the “Starting XMODEM upload” message before activating XMODEM upload on your terminal.
- 6** After a configuration file upload, type `atgo` to restart the switch.

Figure 21 Resetting the Switch: Via the Console Port

```

Bootbase Version: V0.8 | 03/14/2006
RAM:Size = 64 Mbytes
FLASH: Intel 32M
ZyNOS Version: V3.70(AIF.0)b1 | 08/17/2006
Press any key to enter debug mode within 3 seconds.
.....
Enter Debug Mode
GS-4024> atlc
Starting XMODEM upload (CRC mode)....
CCCCCCCCCCCCCCCC
Total 393216 bytes received.
Erasing..
.....
OK
GS-4024> atgo

```

The switch is now reinitialized with a default configuration file including the default password of “1234”.

4.7 Logging Out of the Web Configurator

Click **Logout** in a screen to exit the web configurator. You have to log in with your password again after you log out. This is recommended after you finish a management session for security reasons.

Figure 22 Web Configurator: Logout Screen

4.8 Help

The web configurator's online help has descriptions of individual screens and some supplementary information.

Click the **Help** link from a web configurator screen to view an online help description of that screen.

CHAPTER 5

Initial Setup Example

This chapter shows how to set up the switch for an example network.

5.1 Overview

The following lists the configuration steps for the example network:

- Configure an IP interface
- Configure DHCP server settings
- Create a VLAN
- Set port VLAN ID
- Enable RIP

5.1.1 Configuring an IP Interface

On a layer-3 switch, an IP interface (also known as an IP routing domain) is not bound to a physical port. The default IP address of the switch is 192.168.1.1 with a subnet mask of 255.255.255.0.

In the example network, since the **RD** network is already in the same IP interface as the switch, you don't need to create an IP interface for it. However, if you want to have the **Sales** network on a different routing domain, you need to create a new IP interface. This allows the switch to route traffic between the **RD** and **Sales** networks.

Figure 23 Initial Setup Network Example: IP Interface

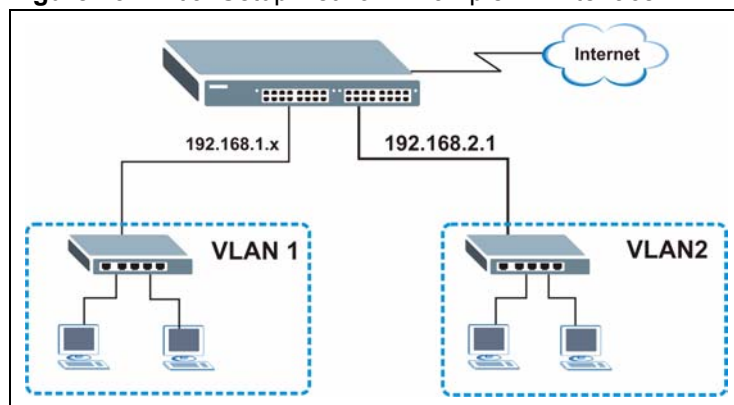

- 1 Connect your computer to the **MGMT** port that is used only for management. Make sure your computer is in the same subnet as the **MGMT** port.

2 Open your web browser and enter 192.168.0.1 (the default **MGMT** port IP address) in the address bar to access the web configurator. See [Section 4.2 on page 47](#) for more information.

3 Click **Basic Setting** and **IP Setup** in the navigation panel.

4 Configure the related fields in the **IP Setup** screen.

For the **Sales** network, enter 192.168.2.1 as the IP address and 255.255.255.0 as the subnet mask.

5 In the **VID** field, enter the ID of the VLAN group to which you want this IP interface to belong. This is the same as the VLAN ID you configure in the **Static VLAN** screen.

6 Click **Add** to save the settings to the run-time memory. Settings in the run-time memory are lost when the switch's power is turned off.

The screenshot shows the 'IP Setup' configuration page. It includes fields for 'Default Gateway' (0.0.0.0), 'Domain Name Server' (0.0.0.0), and 'Default Management' (In-band selected). The 'Management IP Address' section has fields for 'IP Address' (192.168.0.1), 'IP Subnet Mask' (255.255.255.0), and 'Default Gateway' (0.0.0.0). Below this is an 'IP Interface' section with fields for 'IP Address' (192.168.2.1), 'IP Subnet Mask' (255.255.255.0), and 'VID' (2). At the bottom, there is a table with one entry:

Index	IP Address	IP Subnet Mask	VID	Delete
1	192.168.1.12	255.255.255.0	1	<input type="checkbox"/>

5.1.2 Configuring DHCP Server Settings

You can set the switch to assign network information (such as the IP address, DNS server, etc.) to DHCP clients on the network.

For the example network, configure two DHCP client pools on the switch for the DHCP clients in the **RD** and **Sales** networks.

1 In the web configurator, click **IP Application** and **DHCP** in the navigation panel and click the **Server** link.

2 In the **DHCP Server** screen, specify the ID of the VLAN to which the DHCP clients belong, the starting IP address pool, subnet mask, default gateway address and the DNS server address(es).

3 Click **Add** to save the settings to the run-time memory. Settings in the run-time memory are lost when the switch's power is turned off.

The screenshot shows the 'DHCP Server' configuration page. It includes fields for 'VID' (2), 'Client IP Pool Starting Address' (192.168.2.100), 'Size of Client IP Pool' (100), 'IP Subnet Mask' (255.255.255.0), 'Default Gateway' (192.168.2.1), 'Primary DNS Server' (192.168.2.120), and 'Secondary DNS Server' (0.0.0.0). Below this is a table with one entry:

VID	Type	DHCP Status	Delete
1	Server	192.168.1.100/100	<input type="checkbox"/>

5.1.3 Creating a VLAN

VLANs confine broadcast frames to the VLAN group in which the port(s) belongs. You can do this with port-based VLAN or tagged static VLAN with fixed port members.

In this example, you want to configure port 1 as a member of VLAN 2.

Figure 24 Initial Setup Network Example: VLAN

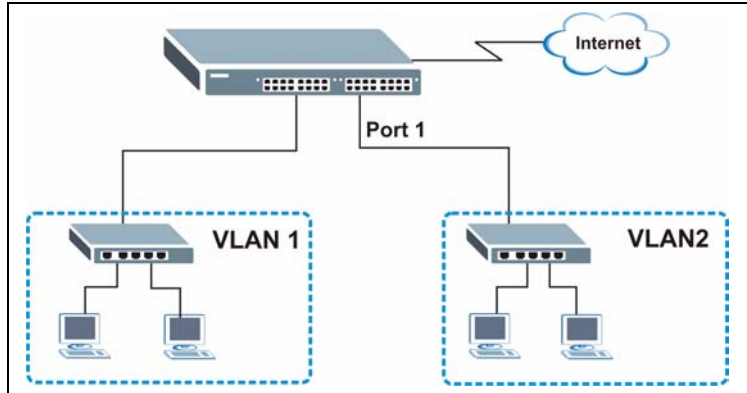

- 1 Click **Advanced Application** and **VLAN** in the navigation panel and click the **Static VLAN** link.

Index	VID	Elapsed Time	Status
1	1	1:00:31	Static

- 2 In the **Static VLAN** screen, select **ACTIVE**, enter a descriptive name in the **Name** field and enter 2 in the **VLAN Group ID** field for the **VLAN2** network.

Note: The **VLAN Group ID** field in this screen and the **VID** field in the **IP Setup** screen refer to the same VLAN ID.

Port	Control	Tagging
*	Normal	<input checked="" type="checkbox"/> Tx Tagging
1	<input type="radio"/> Normal <input checked="" type="radio"/> Fixed <input type="radio"/> Forbidden	<input type="checkbox"/> Tx Tagging
2	<input checked="" type="radio"/> Normal <input type="radio"/> Fixed <input type="radio"/> Forbidden	<input checked="" type="checkbox"/> Tx Tagging
3	<input checked="" type="radio"/> Normal <input type="radio"/> Fixed <input type="radio"/> Forbidden	<input checked="" type="checkbox"/> Tx Tagging
4	<input checked="" type="radio"/> Normal <input type="radio"/> Fixed <input type="radio"/> Forbidden	<input checked="" type="checkbox"/> Tx Tagging
5	<input checked="" type="radio"/> Normal <input type="radio"/> Fixed <input type="radio"/> Forbidden	<input checked="" type="checkbox"/> Tx Tagging
6	<input checked="" type="radio"/> Normal <input type="radio"/> Fixed <input type="radio"/> Forbidden	<input checked="" type="checkbox"/> Tx Tagging
7	<input checked="" type="radio"/> Normal <input type="radio"/> Fixed <input type="radio"/> Forbidden	<input checked="" type="checkbox"/> Tx Tagging

- 3 Since the **VLAN2** network is connected to port 1 on the switch, select **Fixed** to configure port 1 to be a permanent member of the VLAN only.
- 4 To ensure that VLAN-unaware devices (such as computers and hubs) can receive frames properly, clear the **TX Tagging** check box to set the switch to remove VLAN tags before sending.
- 5 Click **Add** to save the settings to the run-time memory. Settings in the run-time memory are lost when the switch's power is turned off.

5.1.4 Setting Port VID

Use PVID to add a tag to incoming untagged frames received on that port so that the frames are forwarded to the VLAN group that the tag defines.

In the example network, configure 2 as the port VID on port 1 so that any untagged frames received on that port get sent to VLAN 2.

Figure 25 Initial Setup Network Example: Port VID

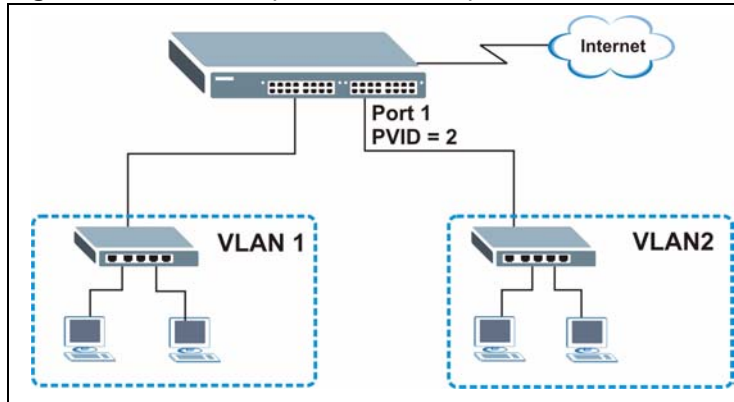

- 1 Click **Advanced Applications** and **VLAN** in the navigation panel. Then click the **VLAN Port Setting** link.
- 2 Enter 2 in the **PVID** field for port 1 and click **Apply** to save your changes back to the run-time memory. Settings in the run-time memory are lost when the switch's power is turned off.

Port	Ingress Check	PVID	GVRP	Acceptable Frame Type	VLAN Trunking
1	<input type="checkbox"/>	2	<input type="checkbox"/>	All	<input type="checkbox"/>
2	<input type="checkbox"/>	1	<input type="checkbox"/>	All	<input type="checkbox"/>
3	<input type="checkbox"/>	1	<input type="checkbox"/>	All	<input type="checkbox"/>
4	<input type="checkbox"/>	1	<input type="checkbox"/>	All	<input type="checkbox"/>
5	<input type="checkbox"/>	1	<input type="checkbox"/>	All	<input type="checkbox"/>
6	<input type="checkbox"/>	1	<input type="checkbox"/>	All	<input type="checkbox"/>
7	<input type="checkbox"/>	1	<input type="checkbox"/>	All	<input type="checkbox"/>

5.1.5 Enabling RIP

To exchange routing information with other routing devices across different routing domains, enable RIP (Routing Information Protocol) in the **RIP** screen.

- 1 Click **IP Application** and **RIP** in the navigation panel.

2 Select **Both** in the **Direction** field to set the switch to broadcast and receive routing information.

3 In the **Version** field, select **RIP-1** for the RIP packet format that is universally supported.

4 Click **Apply** to save your changes back to the run-time memory. Settings in the run-time memory are lost when the switch's power is turned off.

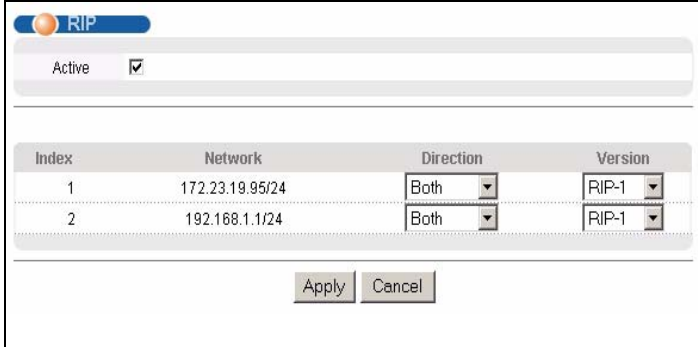

The screenshot shows the RIP configuration interface. At the top, there is a header with the text "RIP" and a small orange circle icon. Below the header, there is a section labeled "Active" with a checked checkbox. The main part of the interface is a table with the following columns: "Index", "Network", "Direction", and "Version". The table contains two rows of data. Below the table, there are two buttons: "Apply" and "Cancel".

Index	Network	Direction	Version
1	172.23.19.95/24	Both	RIP-1
2	192.168.1.1/24	Both	RIP-1

CHAPTER 6

System Status and Port Statistics

This chapter describes the system status (web configurator home page) and port details screens.

6.1 Overview

The home screen of the web configurator displays a port statistical summary with links to each port showing statistical details.

6.2 Port Status Summary

To view the port statistics, click **Status** in all web configurator screens to display the **Status** screen as shown next.

Figure 26 Status

Port	Name	Link	State	LACP	TxPkts	RxPkts	Errors	Tx KB/s	Rx KB/s	Up Time
1		Down	STOP	Disabled	0	0	0	0.0	0.0	0:00:00
2		Down	STOP	Disabled	0	0	0	0.0	0.0	0:00:00
3		Down	STOP	Disabled	0	0	0	0.0	0.0	0:00:00
4		Down	STOP	Disabled	0	0	0	0.0	0.0	0:00:00
5		Down	STOP	Disabled	0	0	0	0.0	0.0	0:00:00
6		Down	STOP	Disabled	0	0	0	0.0	0.0	0:00:00
7		Down	STOP	Disabled	0	0	0	0.0	0.0	0:00:00
8		Down	STOP	Disabled	0	0	0	0.0	0.0	0:00:00

Below the table, there are radio buttons for 'Any' (selected) and 'Port', a text input field, and a 'Clear Counter' button.

The following table describes the labels in this screen.

Table 6 Status

LABEL	DESCRIPTION
Port	This identifies the Ethernet port. Click a port number to display the Port Details screen (refer to Figure 27 on page 65).
Name	This is the name you assigned to this port in the Basic Setting, Port Setup screen.
Link	This field displays the speed (either 10M for 10Mbps, 100M for 100Mbps or 1000M for 1000Mbps) and the duplex (F for full duplex or H for half). It also shows the cable type (Copper or Fiber) for the combo ports.

Table 6 Status (continued)

LABEL	DESCRIPTION
State	If STP (Spanning Tree Protocol) is enabled, this field displays the STP state of the port (see Section 11.1 on page 97 for more information). If STP is disabled, this field displays FORWARDING if the link is up, otherwise, it displays STOP .
LACP	This field displays whether LACP (Link Aggregation Control Protocol) has been enabled on the port.
TxPkts	This field shows the number of transmitted frames on this port.
RxPkts	This field shows the number of received frames on this port.
Errors	This field shows the number of received errors on this port.
Tx KB/s	This field shows the number of kilobytes per second transmitted on this port.
Rx KB/s	This field shows the number of kilobytes per second received on this port.
Up Time	This field shows the total amount of time in hours, minutes and seconds the port has been up.
Clear Counter	Enter a port number and then click Clear Counter to erase the recorded statistical information for that port, or select Any to clear statistics for all ports.

6.2.1 Status: Port Details

Click a number in the **Port** column in the **Status** screen to display individual port statistics. Use this screen to check status and detailed performance data about an individual port on the switch.

Figure 27 Status: Port Details

Port Details		Port Status
Port Info	Port NO.	1
	Name	
	Link	Down
	Status	STOP
	LACP	Disabled
	TxPkts	0
	RxPkts	0
	Errors	0
	Tx KBs/s	0.0
	Rx KBs/s	0.0
	Up Time	0:00:00
TX Packet	TX Packets	0
	Multicast	0
	Broadcast	0
	Pause	0
	Tagged	0
RX Packet	RX Packets	0
	Multicast	0
	Broadcast	0
	Pause	0
	Control	0
TX Collision	Single	0
	Multiple	0
	Excessive	0
	Late	0
Error Packet	RX CRC	0
	Length	0
	Runt	0
Distribution	64	0
	65 to 127	0
	128 to 255	0
	256 to 511	0
	512 to 1023	0
	1024 to 1518	0
	Giant	0

The following table describes the labels in this screen.

Table 7 Status: Port Details

LABEL	DESCRIPTION
Port Info	
Port NO.	This field displays the port number you are viewing.
Name	This field displays the name of the port.
Link	This field displays the speed (either 10M for 10Mbps, 100M for 100Mbps or 1000M for 1000Mbps) and the duplex (F for full duplex or H for half duplex). It also shows the cable type (Copper or Fiber).
Status	If STP (Spanning Tree Protocol) is enabled, this field displays the STP state of the port (see Section 11.1 on page 97 for more information). If STP is disabled, this field displays FORWARDING if the link is up, otherwise, it displays STOP .
LACP	This field shows if LACP is enabled on this port or not.
TxPkts	This field shows the number of transmitted frames on this port
RxPkts	This field shows the number of received frames on this port
Errors	This field shows the number of received errors on this port.

Table 7 Status: Port Details (continued)

LABEL	DESCRIPTION
Tx KB/s	This field shows the number kilobytes per second transmitted on this port.
Rx KB/s	This field shows the number of kilobytes per second received on this port.
Up Time	This field shows the total amount of time the connection has been up.
Tx Packet The following fields display detailed information about packets transmitted.	
TX Packet	This field shows the number of good packets (unicast, multicast and broadcast) transmitted.
Multicast	This field shows the number of good multicast packets transmitted.
Broadcast	This field shows the number of good broadcast packets transmitted.
Pause	This field shows the number of 802.3x Pause packets transmitted.
Tagged	This field shows the number of packets with VLAN tags transmitted.
Rx Packet The following fields display detailed information about packets received.	
RX Packet	This field shows the number of good packets (unicast, multicast and broadcast) received.
Multicast	This field shows the number of good multicast packets received.
Broadcast	This field shows the number of good broadcast packets received.
Pause	This field shows the number of 802.3x Pause packets received.
Control	This field shows the number of control packets received (including those with CRC error) but it does not include the 802.3x Pause packets.
TX Collision The following fields display information on collisions while transmitting.	
Single	This is a count of successfully transmitted packets for which transmission is inhibited by exactly one collision.
Multiple	This is a count of successfully transmitted packets for which transmission was inhibited by more than one collision.
Excessive	This is a count of packets for which transmission failed due to excessive collisions. Excessive collision is defined as the number of maximum collisions before the retransmission count is reset.
Late	This is the number of times a late collision is detected, that is, after 512 bits of the packets have already been transmitted.
Error Packet The following fields display detailed information about packets received that were in error.	
RX CRC	This field shows the number of packets received with CRC (Cyclic Redundant Check) error(s).
Length	This field shows the number of packets received with a length that was out of range.
Runt	This field shows the number of packets received that were too short (shorter than 64 octets), including the ones with CRC errors.
Distribution	
64	This field shows the number of packets (including bad packets) received that were 64 octets in length.
65-127	This field shows the number of packets (including bad packets) received that were between 65 and 127 octets in length.

Table 7 Status: Port Details (continued)

LABEL	DESCRIPTION
128-255	This field shows the number of packets (including bad packets) received that were between 128 and 255 octets in length.
256-511	This field shows the number of packets (including bad packets) received that were between 256 and 511 octets in length.
512-1023	This field shows the number of packets (including bad packets) received that were between 512 and 1023 octets in length.
1024-1518	This field shows the number of packets (including bad packets) received that were between 1024 and 1518 octets in length.
Giant	This field shows the number of packets dropped because they were bigger than the maximum frame size.

CHAPTER 7

Basic Setting

This chapter describes how to configure the **System Info**, **General Setup**, **Switch Setup**, **IP Setup** and **Port Setup** screens.

7.1 Overview

The **System Info** screen displays general switch information (such as firmware version number) and hardware polling information (such as fan speeds). The **General Setup** screen allows you to configure general switch identification information. The **General Setup** screen also allows you to set the system time manually or get the current time and date from an external server when you turn on your switch. The real time is then displayed in the switch logs. The **Switch Setup** screen allows you to set up and configure global switch features. The **IP Setup** screen allows you to configure a switch IP address in each routing domain, subnet mask(s) and DNS (domain name server) for management purposes.

7.2 System Information

In the navigation panel, click **Basic Setting** and **System Info** to display the screen as shown. You can check the firmware version number and monitor the switch temperature, fan speeds and voltage in this screen.

Figure 28 System Info

System Info					
System Name	GS-4024				
ZyNOS F/W Version	V3.70(LL.0)b3 07/27/2006				
Ethernet Address	00:13:49:1e:77:9b				
Hardware Monitor					
Temperature Unit	<input type="button" value="C"/>				
Temperature (C)	Current	MAX	MIN	Threshold	Status
MAC	35.0	36.0	26.0	65.0	Normal
CPU	34.0	34.5	25.0	65.0	Normal
PHY	40.0	40.5	28.5	65.0	Normal
FAN Speed (RPM)	Current	MAX	MIN	Threshold	Status
FAN1	6450	6510	6194	3250	Normal
FAN2	6392	6450	6167	3250	Normal
FAN3	6540	6571	6334	3250	Normal
Voltage (V)	Current	MAX	MIN	Threshold	Status
VCOREA	2.576	2.576	2.576	+/-8%	Normal
VINRO	1.232	1.232	1.232	+/-11%	Normal
3.3VIN	3.344	3.344	3.344	+/-7%	Normal
AVCC	4.972	4.972	4.972	+/-7%	Normal
+12VIN	12.342	12.342	12.281	+/-11%	Normal
-12VIN	1.248	1.248	1.248	+/-8%	Normal
5VSB	1.328	1.328	1.328	+/-10%	Normal
-5VIN	1.248	1.248	1.248	+/-8%	Normal
VBAT	--	--	--	--	Absent

The following table describes the labels in this screen.

Table 8 System Info

LABEL	DESCRIPTION
System Name	This field displays the descriptive name of the switch for identification purposes.
ZyNOS F/W Version	This field displays the version number of the switch 's current firmware including the date created.
Ethernet Address	This field refers to the Ethernet MAC (Media Access Control) address of the switch.
Hardware Monitor	
Temperature Unit	The switch has temperature sensors that are capable of detecting and reporting if the temperature rises above the threshold. You may choose the temperature unit (Centigrade or Fahrenheit) in this field.
Temperature	MAC , CPU and PHY refer to the location of the temperature sensors on the switch printed circuit board.
Current	This shows the current temperature in degrees centigrade at this sensor.
MAX	This field displays the maximum temperature measured at this sensor.
MIN	This field displays the minimum temperature measured at this sensor.
Threshold	This field displays the upper temperature limit at this sensor.
Status	This field displays Normal for temperatures below the threshold and Error for those above.

Table 8 System Info (continued)

LABEL	DESCRIPTION
Fan Speed (RPM)	A properly functioning fan is an essential component (along with a sufficiently ventilated, cool operating environment) in order for the device to stay within the temperature threshold. Each fan has a sensor that is capable of detecting and reporting if the fan speed falls below the threshold shown.
Current	This field displays this fan's current speed in Revolutions Per Minute (RPM).
MAX	This field displays this fan's maximum speed measured in Revolutions Per Minute (RPM).
MIN	This field displays this fan's minimum speed measured in Revolutions Per Minute (RPM). "<41" is displayed for speeds too small to measure (under 2000 RPM).
Threshold	This field displays the minimum speed at which a normal fan should work.
Status	Normal indicates that this fan is functioning above the minimum speed. Error indicates that this fan is functioning below the minimum speed.
Voltage(V)	The power supply for each voltage has a sensor that is capable of detecting and reporting if the voltage falls out of the tolerance range.
Current	This is the current voltage reading.
MAX	This field displays the maximum voltage measured at this point.
MIN	This field displays the minimum voltage measured at this point.
Threshold	This field displays the percentage tolerance of the voltage with which the switch still works.
Status	Normal indicates that the voltage is within an acceptable operating range at this point; otherwise Error is displayed.

7.3 General Setup

Use this screen to configure general settings such as the system name and time. Click **Basic Setting** and **General Setup** in the navigation panel to display the screen as shown.

Figure 29 General Setup

The following table describes the labels in this screen.

Table 9 General Setup

LABEL	DESCRIPTION
System Name	Choose a descriptive name for identification purposes. This name consists of up to 64 printable characters; spaces are allowed.
Location	Enter the geographic location of your switch. You can use up to 32 printable ASCII characters; spaces are allowed.
Contact Person's Name	Enter the name of the person in charge of this switch. You can use up to 32 printable ASCII characters; spaces are allowed.
Login Precedence	<p>Use this drop-down list box to select which database the switch should use (first) to authenticate an administrator (user for switch management).</p> <p>Configure the local user accounts in the Access Control Logins screen. The RADIUS is an external server. Before you specify the priority, make sure you have set up the corresponding database correctly first.</p> <p>Select Local Only to have the switch just check the administrator accounts configured in the Access Control Logins screen.</p> <p>Select Local then RADIUS to have the switch check the administrator accounts configured in the Access Control Logins screen. If the user name is not found, the switch then checks the user database on the specified RADIUS server. You need to configure Port Authentication Radius first.</p> <p>Select RADIUS Only to have the switch just check the user database on the specified RADIUS server for a login username, password and the access privilege.</p>

Table 9 General Setup (continued)

LABEL	DESCRIPTION
Use Time Server when Bootup	<p>Enter the time service protocol that your timeserver uses. Not all time servers support all protocols, so you may have to use trial and error to find a protocol that works. The main differences between them are the time format.</p> <p>When you select the Daytime (RFC 867) format, the switch displays the day, month, year and time with no time zone adjustment. When you use this format it is recommended that you use a Daytime timeserver within your geographical time zone.</p> <p>Time (RFC-868) format displays a 4-byte integer giving the total number of seconds since 1970/1/1 at 0:0:0.</p> <p>NTP (RFC-1305) is similar to Time (RFC-868).</p> <p>None is the default value. Enter the time manually. Each time you turn on the switch, the time and date will be reset to 1970-1-1 0:0.</p>
Time Server IP Address	Enter the IP address of your timeserver. The switch searches for the timeserver for up to 60 seconds. If you select a timeserver that is unreachable, then this screen will appear locked for 60 seconds. Please wait.
Current Time	This field displays the time you open this menu (or refresh the menu).
New Time (hh:min:ss)	Enter the new time in hour, minute and second format. The new time then appears in the Current Time field after you click Apply .
Current Date	This field displays the date you open this menu.
New Date (yyyy-mm-dd)	Enter the new date in year, month and day format. The new date then appears in the Current Date field after you click Apply .
Time Zone	Select the time difference between UTC (Universal Time Coordinated, formerly known as GMT, Greenwich Mean Time) and your time zone from the drop-down list box.
Apply	Click Apply to save your changes to the switch's run-time memory. The switch loses these changes if it is turned off or loses power, so use the Save link on the top navigation panel to save your changes to the non-volatile memory when you are done configuring.
Cancel	Click Cancel to reset the fields.

7.4 Introduction to VLANs

A VLAN (Virtual Local Area Network) allows a physical network to be partitioned into multiple logical networks. Devices on a logical network belong to one group. A device can belong to more than one group. With VLAN, a device cannot directly talk to or hear from devices that are not in the same group(s); the traffic must first go through a router.

In MTU (Multi-Tenant Unit) applications, VLAN is vital in providing isolation and security among the subscribers. When properly configured, VLAN prevents one subscriber from accessing the network resources of another on the same LAN, thus a user will not see the printers and hard disks of another user in the same building.

VLAN also increases network performance by limiting broadcasts to a smaller and more manageable logical broadcast domain. In traditional switched environments, all broadcast packets go to each and every individual port. With VLAN, all broadcasts are confined to a specific broadcast domain.

Note: VLAN is unidirectional; it only governs outgoing traffic.

See [Chapter 8 on page 81](#) for information on port-based and 802.1Q tagged VLANs.

7.5 Switch Setup Screen

Click **Basic Setting** and then **Switch Setup** in the navigation panel to display the screen as shown. The VLAN setup screens change depending on whether you choose **802.1Q** or **Port Based** in the **VLAN Type** field in this screen. Refer to the chapter on VLAN.

Figure 30 Switch Setup

The following table describes the labels in this screen.

Table 10 Switch Setup

LABEL	DESCRIPTION
VLAN Type	Choose 802.1Q or Port Based . The VLAN Setup screen changes depending on whether you choose 802.1Q VLAN type or Port Based VLAN type in this screen. See Chapter 8 on page 81 for more information.
Bridge Control Protocol Transparency	Select Active to allow the switch to handle bridging control protocols (STP for example). You also need to define how to treat a BPDU in the Port Setup screen.
MAC Address Learning	MAC address learning reduces outgoing traffic broadcasts. For MAC address learning to occur on a port, the port must be active.
Aging Time	Enter a time from 10 to 3000 seconds. This is how long all dynamically learned MAC addresses remain in the MAC address table before they age out (and must be relearned).
GARP Timer: Switches join VLANs by making a declaration. A declaration is made by issuing a Join message using GARP. Declarations are withdrawn by issuing a Leave message. A Leave All message terminates all registrations. GARP timers set declaration timeout values. See the chapter on VLAN setup for more background information.	

Table 10 Switch Setup (continued)

LABEL	DESCRIPTION
Join Timer	Join Timer sets the duration of the Join Period timer for GVRP in milliseconds. Each port has a Join Period timer. The allowed Join Time range is between 100 and 65535 milliseconds; the default is 200 milliseconds. See the chapter on VLAN setup for more background information.
Leave Timer	Leave Time sets the duration of the Leave Period timer for GVRP in milliseconds. Each port has a single Leave Period timer. Leave Time must be two times larger than Join Timer ; the default is 600 milliseconds.
Leave All Timer	Leave All Timer sets the duration of the Leave All Period timer for GVRP in milliseconds. Each port has a single Leave All Period timer. Leave All Timer must be larger than Leave Timer.
<p>Priority Queue Assignment</p> <p>IEEE 802.1p defines up to eight separate traffic types by inserting a tag into a MAC-layer frame that contains bits to define class of service. Frames without an explicit priority tag are given the default priority of the ingress port. Use the next two fields to configure the priority level-to-physical queue mapping.</p> <p>The switch has eight physical queues that you can map to the 8 priority levels. On the switch, traffic assigned to higher index queues gets through faster while traffic in lower index queues is dropped if the network is congested.</p>	
Priority Level (The following descriptions are based on the traffic types defined in the IEEE 802.1d standard (which incorporates the 802.1p)).	
Level 7	Typically used for network control traffic such as router configuration messages.
Level 6	Typically used for voice traffic that is especially sensitive to jitter (jitter is the variations in delay).
Level 5	Typically used for video that consumes high bandwidth and is sensitive to jitter.
Level 4	Typically used for controlled load, latency-sensitive traffic such as SNA (Systems Network Architecture) transactions.
Level 3	Typically used for "excellent effort" or better than best effort and would include important business traffic that can tolerate some delay.
Level 2	This is for "spare bandwidth".
Level 1	This is typically used for non-critical "background" traffic such as bulk transfers that are allowed but that should not affect other applications and users.
Level 0	Typically used for best-effort traffic.
Apply	Click Apply to save your changes to the switch's run-time memory. The switch loses these changes if it is turned off or loses power, so use the Save link on the top navigation panel to save your changes to the non-volatile memory when you are done configuring.
Cancel	Click Cancel to reset the fields.

7.6 IP Setup

Use the **IP Setup** screen to configure the default gateway device, the default domain name server and add IP domains.

7.6.1 IP Interfaces

The switch needs an IP address for it to be managed over the network. The factory default IP address is 192.168.1.1. The subnet mask specifies the network number portion of an IP address. The factory default subnet mask is 255.255.255.0.

On the switch, as a layer-3 device, an IP address is not bound to any physical ports. Since each IP address on the switch must be in a separate subnet, the configured IP address is also known as IP interface (or routing domain). In addition, this allows routing between subnets based on the IP address without additional routers.

You can configure multiple routing domains on the same VLAN as long as the IP address ranges for the domains do not overlap. To change the IP address of the switch in a routing domain, simply add a new routing domain entry with a different IP address in the same subnet.

Figure 31 IP Setup

IP Setup

Default Gateway:

Domain Name Server:

Default Management: In-band Out-of-band

Management IP Address

IP Address:

IP Subnet Mask:

Default Gateway:

IP Interface

IP Address:

IP Subnet Mask:

VID:

Index	IP Address	IP Subnet Mask	VID	Delete
1	192.168.1.12	255.255.255.0	1	<input type="checkbox"/>

The following table describes the labels in this screen.

Table 11 IP Setup

LABEL	DESCRIPTION
Default Gateway	Enter the IP address of the default outgoing gateway in dotted decimal notation, for example 192.168.1.254.
Domain Name Server	DNS (Domain Name System) is for mapping a domain name to its corresponding IP address and vice versa. Enter a domain name server IP address in order to be able to use a domain name instead of an IP address.
Default Management	Specify which traffic flow (In-Band or Out-of-band) the switch is to send packets originating from itself (such as SNMP traps) or packets with unknown source. Select Out-of-band to have the switch send the packets to the management port labelled MGMT . This means that device(s) connected to the other port(s) do not receive these packets. Select In-Band to have the switch send the packets to all ports except the management port (labelled MGMT) to which connected device(s) do not receive these packets.
Management IP Address Use these fields to set the settings for the out-of-band management port.	
IP Address	Enter the out-of-band management IP address of your switch in dotted decimal notation. For example, 192.168.0.1.
IP Subnet Mask	Enter the IP subnet mask of your switch in dotted decimal notation for example 255.255.255.0.
Default Gateway	Enter the IP address of the default outgoing gateway in dotted decimal notation, for example 192.168.0.254
Apply	Click Apply to save your changes to the switch's run-time memory. The switch loses these changes if it is turned off or loses power, so use the Save link on the top navigation panel to save your changes to the non-volatile memory when you are done configuring.
Cancel	Click Cancel to reset the fields to your previous configuration.
IP Interface Use these fields to create or edit IP routing domains on the switch.	
IP Address	Enter the IP address of your switch in dotted decimal notation for example 192.168.1.1. This is the IP address of the switch in an IP routing domain.
IP Subnet Mask	Enter the IP subnet mask of an IP routing domain in dotted decimal notation. For example, 255.255.255.0.
VID	Enter the VLAN identification number to which an IP routing domain belongs.
Add	Click Add to save your changes to the switch's run-time memory. The switch loses these changes if it is turned off or loses power, so use the Save link on the top navigation panel to save your changes to the non-volatile memory when you are done configuring.
Cancel	Click Cancel to reset the fields to your previous configuration.
Index	This field displays the index number of an entry.
IP Address	This field displays IP address of the switch in the IP domain.
Subnet Mask	This field displays the subnet mask of the switch in the IP domain.
VID	This field displays the VLAN identification number of the IP domain on the switch.

Table 11 IP Setup (continued)

LABEL	DESCRIPTION
Delete	Click Delete to remove the selected entry from the summary table. Note: Deleting all IP subnets locks you out from the switch.
Cancel	Click Cancel to clear the Delete check boxes.

7.7 Port Setup

Use this screen to configure switch port settings. Click **Basic Setting** and then **Port Setup** in the navigation panel to display the configuration screen.

Figure 32 Port Setup

Port	Active	Name	Type	Speed / Duplex	Flow Control	802.1p Priority	BPDU Control
*	<input type="checkbox"/>		-	Auto	<input type="checkbox"/>	0	Peer
1	<input checked="" type="checkbox"/>		10/100/1000M	Auto	<input type="checkbox"/>	0	Peer
2	<input checked="" type="checkbox"/>		10/100/1000M	Auto	<input type="checkbox"/>	0	Peer
3	<input checked="" type="checkbox"/>		10/100/1000M	Auto	<input type="checkbox"/>	0	Peer
4	<input checked="" type="checkbox"/>		10/100/1000M	Auto	<input type="checkbox"/>	0	Peer
5	<input checked="" type="checkbox"/>		10/100/1000M	Auto	<input type="checkbox"/>	0	Peer
6	<input checked="" type="checkbox"/>		10/100/1000M	Auto	<input type="checkbox"/>	0	Peer
7	<input checked="" type="checkbox"/>		10/100/1000M	Auto	<input type="checkbox"/>	0	Peer
8	<input checked="" type="checkbox"/>		10/100/1000M	Auto	<input type="checkbox"/>	0	Peer

Apply Cancel

The following table describes the labels in this screen.

Table 12 Port Setup

LABEL	DESCRIPTION
Port	This is the port index number.
*	Settings in this row apply to all ports. Use this row only if you want to make some settings the same for all ports. Use this row first to set the common settings and then make adjustments on a port-by-port basis. Note: Changes in this row are copied to all the ports as soon as you make them.
Active	Select this check box to enable a port. The factory default for all ports is enabled. A port must be enabled for data transmission to occur.

Table 12 Port Setup (continued)

LABEL	DESCRIPTION
Name	<p>Enter a descriptive name that identifies this port. You can enter up to 64 alpha-numerical characters.</p> <p>Note: Due to space limitation, the port name may be truncated in some web configurator screens.</p>
Type	This field displays 10/100/1000M for Gigabit connections.
Speed/Duplex	<p>Select the speed and the duplex mode of the Ethernet connection on this port. Choices are Auto, 10M/Half Duplex, 10M/Full Duplex, 100M/Half Duplex, 100M/Full Duplex and 1000M/Full Duplex.</p> <p>Selecting Auto (auto-negotiation) allows one port to negotiate with a peer port automatically to obtain the connection speed and duplex mode that both ends support. When auto-negotiation is turned on, a port on the switch negotiates with the peer automatically to determine the connection speed and duplex mode. If the peer port does not support auto-negotiation or turns off this feature, the switch determines the connection speed by detecting the signal on the cable and using half duplex mode. When the switch's auto-negotiation is turned off, a port uses the pre-configured speed and duplex mode when making a connection, thus requiring you to make sure that the settings of the peer port are the same in order to connect.</p>
Flow Control	<p>A concentration of traffic on a port decreases port bandwidth and overflows buffer memory causing packet discards and frame losses. Flow Control is used to regulate transmission of signals to match the bandwidth of the receiving port.</p> <p>The switch uses IEEE802.3x flow control in full duplex mode and backpressure flow control in half duplex mode.</p> <p>IEEE802.3x flow control is used in full duplex mode to send a pause signal to the sending port, causing it to temporarily stop sending signals when the receiving port memory buffers fill.</p> <p>Back Pressure flow control is typically used in half duplex mode to send a "collision" signal to the sending port (mimicking a state of packet collision) causing the sending port to temporarily stop sending signals and resend later. Select Flow Control to enable it.</p>
802.1p Priority	This priority value is added to incoming frames without a (802.1p) priority queue tag. See Priority Queue Assignment in Table 10 on page 74 for more information.
BPDU Control	<p>Configure the way to treat BPDUs received on this port. You must activate bridging control protocol transparency in the Switch Setup screen first.</p> <p>Select Peer to process any BPDU (Bridge Protocol Data Units) received on this port.</p> <p>Select Tunnel to forward BPDUs received on this port.</p> <p>Select Discard to drop any BPDU received on this port.</p> <p>Select Network to process a BPDU with no VLAN tag and forward a tagged BPDU.</p>
Apply	Click Apply to save your changes to the switch's run-time memory. The switch loses these changes if it is turned off or loses power, so use the Save link on the top navigation panel to save your changes to the non-volatile memory when you are done configuring.
Cancel	Click Cancel to reset the fields.

CHAPTER 8

VLAN

The type of screen you see here depends on the **VLAN Type** you selected in the **Switch Setup** screen. This chapter shows you how to configure 802.1Q tagged and port-based VLANs.

8.1 Introduction to IEEE 802.1Q Tagged VLANs

A tagged VLAN uses an explicit tag (VLAN ID) in the MAC header to identify the VLAN membership of a frame across bridges - they are not confined to the switch on which they were created. The VLANs can be created statically by hand or dynamically through GVRP. The VLAN ID associates a frame with a specific VLAN and provides the information that switches need to process the frame across the network. A tagged frame is four bytes longer than an untagged frame and contains two bytes of TPID (Tag Protocol Identifier, residing within the type/length field of the Ethernet frame) and two bytes of TCI (Tag Control Information, starts after the source address field of the Ethernet frame).

The CFI (Canonical Format Indicator) is a single-bit flag, always set to zero for Ethernet switches. If a frame received at an Ethernet port has a CFI set to 1, then that frame should not be forwarded as it is to an untagged port. The remaining twelve bits define the VLAN ID, giving a possible maximum number of 4,096 VLANs. Note that user priority and VLAN ID are independent of each other. A frame with VID (VLAN Identifier) of null (0) is called a priority frame, meaning that only the priority level is significant and the default VID of the ingress port is given as the VID of the frame. Of the 4096 possible VIDs, a VID of 0 is used to identify priority frames and value 4095 (FFF) is reserved, so the maximum possible VLAN configurations are 4,094.

TPID	User Priority	CFI	VLAN ID
2 Bytes	3 Bits	1 Bit	12 bits

8.1.1 Forwarding Tagged and Untagged Frames

Each port on the switch is capable of passing tagged or untagged frames. To forward a frame from an 802.1Q VLAN-aware switch to an 802.1Q VLAN-unaware switch, the switch first decides where to forward the frame and then strips off the VLAN tag. To forward a frame from an 802.1Q VLAN-unaware switch to an 802.1Q VLAN-aware switch, the switch first decides where to forward the frame, and then inserts a VLAN tag reflecting the ingress port's default VID. The default PVID is VLAN 1 for all ports, but this can be changed.

A broadcast frame (or a multicast frame for a multicast group that is known by the system) is duplicated only on ports that are members of the VID (except the ingress port itself), thus confining the broadcast to a specific domain.

8.2 Automatic VLAN Registration

GARP and GVRP are the protocols used to automatically register VLAN membership across switches.

8.2.1 GARP

GARP (Generic Attribute Registration Protocol) allows network switches to register and de-register attribute values with other GARP participants within a bridged LAN. GARP is a protocol that provides a generic mechanism for protocols that serve a more specific application, for example, GVRP.

8.2.1.1 GARP Timers

Switches join VLANs by making a declaration. A declaration is made by issuing a Join message using GARP. Declarations are withdrawn by issuing a Leave message. A Leave All message terminates all registrations. GARP timers set declaration timeout values.

8.2.2 GVRP

GVRP (GARP VLAN Registration Protocol) is a registration protocol that defines a way for switches to register necessary VLAN members on ports across the network. Enable this function to permit VLANs groups beyond the local switch.

Please refer to the following table for common IEEE 802.1Q VLAN terminology.

Table 13 IEEE 802.1Q VLAN Terminology

VLAN PARAMETER	TERM	DESCRIPTION
VLAN Type	Permanent VLAN	This is a static VLAN created manually.
	Dynamic VLAN	This is a VLAN configured by a GVRP registration/deregistration process.
VLAN Administrative Control	Registration Fixed	Fixed registration ports are permanent VLAN members.
	Registration Forbidden	Ports with registration forbidden are forbidden to join the specified VLAN.
	Normal Registration	Ports dynamically join a VLAN using GVRP.
VLAN Tag Control	Tagged	Ports belonging to the specified VLAN tag all outgoing frames transmitted.
	Untagged	Ports belonging to the specified VLAN don't tag all outgoing frames transmitted.

Table 13 IEEE 802.1Q VLAN Terminology (continued)

VLAN PARAMETER	TERM	DESCRIPTION
VLAN Port	Port VID	This is the VLAN ID assigned to untagged frames that this port received.
	Acceptable Frame Type	You may choose to accept both tagged and untagged incoming frames, just tagged incoming frames or just untagged incoming frames on a port.
	Ingress filtering	If set, the switch discards incoming frames for VLANs that do not have this port as a member

8.3 Port VLAN Trunking

Enable **VLAN Trunking** on a port to allow frames belonging to unknown VLAN groups to pass through that port. This is useful if you want to set up VLAN groups on end devices without having to configure the same VLAN groups on intermediary devices.

Refer to the following figure. Suppose you want to create VLAN groups 1 and 2 (V1 and V2) on devices A and B. Without **VLAN Trunking**, you must configure VLAN groups 1 and 2 on all intermediary switches C, D and E; otherwise they will drop frames with unknown VLAN group tags. However, with **VLAN Trunking** enabled on a port(s) in each intermediary switch you only need to create VLAN groups in the end devices (A and B). C, D and E automatically allow frames with VLAN group tags 1 and 2 (VLAN groups that are unknown to those switches) to pass through their VLAN trunking port(s).

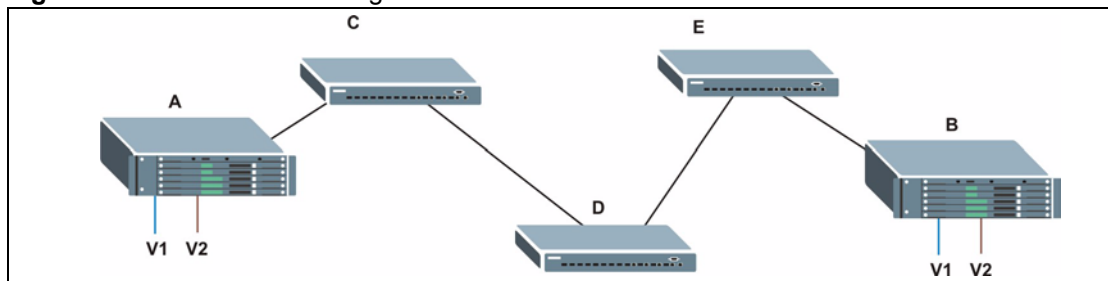
Figure 33 Port VLAN Trunking

8.4 Select the VLAN Type

Select a VLAN type in the **Switch Setup** screen.

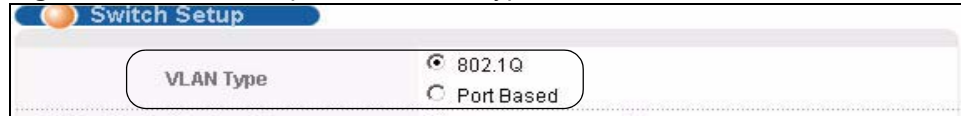
Figure 34 Switch Setup: Select VLAN Type

8.5 Static VLAN

Use a static VLAN to decide whether an incoming frame on a port should be

- sent to a VLAN group as normal depending on its VLAN tag.
- sent to a group whether it has a VLAN tag or not.
- blocked from a VLAN group regardless of its VLAN tag.

You can also tag all outgoing frames (that were previously untagged) from a port with the specified VID.

8.5.1 Static VLAN Status

See [Section 8.1 on page 81](#) for more information on Static VLAN. Click **Advanced Application, VLAN** from the navigation panel to display the **VLAN Status** screen as shown next.

Figure 35 VLAN: VLAN Status

The following table describes the labels in this screen.

Table 14 VLAN: VLAN Status

LABEL	DESCRIPTION
The Number of VLAN	This is the number of VLANs configured on the switch.
Index	This is the VLAN index number. Click on an index number to view more VLAN details.
VID	This is the VLAN identification number that was configured in the Static VLAN screen.
Elapsed Time	This field shows how long it has been since a normal VLAN was registered or a static VLAN was set up.

Table 14 VLAN: VLAN Status (continued)

LABEL	DESCRIPTION
Status	This field shows how this VLAN was added to the switch; dynamic - using GVRP, static - added as a permanent entry or other - added in another way such as via Multicast VLAN Registration (MVR).
Change Pages	Click Previous or Next to show the previous/next screen if all status information cannot be seen in one screen.

8.5.2 Static VLAN Details

Use this screen to view detailed port settings and status of the VLAN group. See [Section 8.1 on page 81](#) for more information on static VLAN. Click on an index number in the **VLAN Status** screen to display VLAN details.

Figure 36 Static VLAN Details

VID	Port Number												Elapsed Time	Status
	2	4	6	8	10	12	14	16	18	20	22	24		
1	U	U	U	U	U	U	U	U	U	U	U	U	2:12:57	Static

The following table describes the labels in this screen.

Table 15 Static VLAN Details

LABEL	DESCRIPTION
VLAN Status	Click this to go to the VLAN Status screen.
VID	This is the VLAN identification number that was configured in the Static VLAN screen.
Port Number	This column displays the ports that are participating in a VLAN. A tagged port is marked as T , an untagged port is marked as U and ports not participating in a VLAN are marked as - .
Elapsed Time	This field shows how long it has been since a normal VLAN was registered or a static VLAN was set up.
Status	This field shows how this VLAN was added to the switch; dynamic - using GVRP, static - added as a permanent entry or other - added in another way such as via Multicast VLAN Registration (MVR).

8.5.3 Configure a Static VLAN

Use this screen to configure and view 802.1Q VLAN parameters for the switch. See [Section 8.1 on page 81](#) for more information on static VLAN. To configure a static VLAN, click **Static VLAN** in the **VLAN Status** screen to display the screen as shown next.

Figure 37 VLAN: Static VLAN

The screenshot shows the 'Static VLAN' configuration screen. At the top, there is a title bar with 'Static VLAN' and 'VLAN Status'. Below the title bar, there is an 'ACTIVE' checkbox. Underneath, there are two input fields: 'Name' and 'VLAN Group ID'. The main part of the screen is a table with three columns: 'Port', 'Control', and 'Tagging'. The 'Port' column has a row for '*' and rows for ports 1 through 8. The 'Control' column has a dropdown menu set to 'Normal' and radio buttons for 'Normal', 'Fixed', and 'Forbidden'. The 'Tagging' column has a checked checkbox for 'Tx Tagging'. Below the table, there are three buttons: 'Add', 'Cancel', and 'Clear'. At the bottom of the screen, there is another table with four columns: 'VID', 'Active', 'Name', and 'Delete'. This table has one row with '1', 'Yes', '1', and a checkbox. Below this table are two buttons: 'Delete' and 'Cancel'.

The following table describes the related labels in this screen.

Table 16 VLAN: Static VLAN

LABEL	DESCRIPTION
ACTIVE	Select this check box to activate the VLAN settings.
Name	Enter a descriptive name for the VLAN group for identification purposes.
VLAN Group ID	Enter the VLAN ID for this static entry; the valid range is between 1 and 4094.
Port	The port number identifies the port you are configuring.
*	Settings in this row apply to all ports. Use this row only if you want to make some settings the same for all ports. Use this row first to set the common settings and then make adjustments on a port-by-port basis. Note: Changes in this row are copied to all the ports as soon as you make them.
Control	Select Normal for the port to dynamically join this VLAN group using GVRP. This is the default selection. Select Fixed for the port to be a permanent member of this VLAN group. Select Forbidden if you want to prohibit the port from joining this VLAN group.
Tagging	Select TX Tagging if you want the port to tag all outgoing frames transmitted with this VLAN Group ID.

Table 16 VLAN: Static VLAN (continued)

LABEL	DESCRIPTION
Add	Click Add to save your changes to the switch's run-time memory. The switch loses these changes if it is turned off or loses power, so use the Save link on the top navigation panel to save your changes to the non-volatile memory when you are done configuring.
Cancel	Click Cancel to reset the fields.
Clear	Click Clear to start configuring the screen again.
VID	This field displays the ID number of the VLAN group. Click the number to edit the VLAN settings.
Active	This field indicates whether the VLAN settings are enabled (Yes) or disabled (No).
Name	This field displays the descriptive name for this VLAN group.
Delete	Click Delete to remove the selected entry from the summary table.
Cancel	Click Cancel to clear the Delete check boxes.

8.5.4 Configure VLAN Port Settings

Use the VLAN Port Setting screen to configure the static VLAN (IEEE 802.1Q) settings on a port. See [Section 8.1 on page 81](#) for more information on static VLAN. Click the **VLAN Port Setting** link in the **VLAN Status** screen.

Figure 38 VLAN: VLAN Port Setting

Port	Ingress Check	PVID	GVRP	Acceptable Frame Type	VLAN Trunking
*	<input type="checkbox"/>		<input type="checkbox"/>	All	<input type="checkbox"/>
1	<input type="checkbox"/>	1	<input type="checkbox"/>	All	<input type="checkbox"/>
2	<input type="checkbox"/>	1	<input type="checkbox"/>	All	<input type="checkbox"/>
3	<input type="checkbox"/>	1	<input type="checkbox"/>	All	<input type="checkbox"/>
4	<input type="checkbox"/>	1	<input type="checkbox"/>	All	<input type="checkbox"/>
5	<input type="checkbox"/>	1	<input type="checkbox"/>	All	<input type="checkbox"/>
6	<input type="checkbox"/>	1	<input type="checkbox"/>	All	<input type="checkbox"/>
7	<input type="checkbox"/>	1	<input type="checkbox"/>	All	<input type="checkbox"/>
8	<input type="checkbox"/>	1	<input type="checkbox"/>	All	<input type="checkbox"/>

Apply Cancel

The following table describes the labels in this screen.

Table 17 VLAN: VLAN Port Setting

LABEL	DESCRIPTION
GVRP	GVRP (GARP VLAN Registration Protocol) is a registration protocol that defines a way for switches to register necessary VLAN members on ports across the network. Select this check box to permit VLAN groups beyond the local switch.
Port Isolation	Port Isolation allows each port to communicate only with the CPU management port and the dual personality GbE interfaces but not communicate with each other. This option is the most limiting but also the most secure.
Port	This field displays the port number.
*	Settings in this row apply to all ports. Use this row only if you want to make some settings the same for all ports. Use this row first to set the common settings and then make adjustments on a port-by-port basis. Note: Changes in this row are copied to all the ports as soon as you make them.
Ingress Check	If this check box is selected for a port, the switch discards incoming frames for VLANs that do not include this port in its member set. Clear this check box to disable ingress filtering.
PVID	Enter a number between 1 and 4094 as the port VLAN ID.
GVRP	Select this check box to allow GVRP on this port.
Acceptable Frame Type	Specify the type of frames allowed on a port. Choices are All , Tag Only and Untag Only . Select All from the drop-down list box to accept all untagged or tagged frames on this port. This is the default setting. Select Tag Only to accept only tagged frames on this port. All untagged frames will be dropped. Select Untag Only to accept only untagged frames on this port. All tagged frames will be dropped.
VLAN Trunking	Enable VLAN Trunking on ports connected to other switches or routers (but not ports directly connected to end users) to allow frames belonging to unknown VLAN groups to pass through the switch.
Apply	Click Apply to save your changes to the switch's run-time memory. The switch loses these changes if it is turned off or loses power, so use the Save link on the top navigation panel to save your changes to the non-volatile memory when you are done configuring.
Cancel	Click Cancel to reset the fields.

8.6 Port-based VLAN Setup

Port-based VLANs are VLANs where the packet forwarding decision is based on the destination MAC address and its associated port.

Port-based VLANs require allowed outgoing ports to be defined for each port. Therefore, if you wish to allow two subscriber ports to talk to each other, for example, between conference rooms in a hotel, you must define the egress (an egress port is an outgoing port, that is, a port through which a data packet leaves) for both ports.

Port-based VLANs are specific only to the switch on which they were created.

Note: When you activate port-based VLAN, the switch uses a default VLAN ID of 1. You cannot change it.

In screens (such as **IP Setup** and **Filtering**) that require a VID, you must enter 1 as the VID.

The port-based VLAN setup screen is shown next. The **CPU** management port forms a VLAN with all Ethernet ports.

8.6.1 Configure a Port-based VLAN

Select **Port Based** as the **VLAN Type** in the **Switch Setup** screen and then click **VLAN** from the navigation panel to display the next screen.

Figure 39 Port Based VLAN Setup (All Connected)

Port Based VLAN Setup

Setting Wizard | All connected | Apply

Incoming

	1	2	3	4	5	6	7	8	9	10	11	12	13	14	15	16	17	18	19	20	21	22	23	24	
1	<input checked="" type="checkbox"/>	<input checked="" type="checkbox"/>	<input checked="" type="checkbox"/>	<input checked="" type="checkbox"/>	<input checked="" type="checkbox"/>	<input checked="" type="checkbox"/>	<input checked="" type="checkbox"/>	<input checked="" type="checkbox"/>	<input checked="" type="checkbox"/>	<input checked="" type="checkbox"/>	<input checked="" type="checkbox"/>	<input checked="" type="checkbox"/>	<input checked="" type="checkbox"/>	<input checked="" type="checkbox"/>	<input checked="" type="checkbox"/>	<input checked="" type="checkbox"/>	<input checked="" type="checkbox"/>	<input checked="" type="checkbox"/>	<input checked="" type="checkbox"/>	<input checked="" type="checkbox"/>	<input checked="" type="checkbox"/>	<input checked="" type="checkbox"/>	<input checked="" type="checkbox"/>	<input checked="" type="checkbox"/>	1
2	<input checked="" type="checkbox"/>	<input checked="" type="checkbox"/>	<input checked="" type="checkbox"/>	<input checked="" type="checkbox"/>	<input checked="" type="checkbox"/>	<input checked="" type="checkbox"/>	<input checked="" type="checkbox"/>	<input checked="" type="checkbox"/>	<input checked="" type="checkbox"/>	<input checked="" type="checkbox"/>	<input checked="" type="checkbox"/>	<input checked="" type="checkbox"/>	<input checked="" type="checkbox"/>	<input checked="" type="checkbox"/>	<input checked="" type="checkbox"/>	<input checked="" type="checkbox"/>	<input checked="" type="checkbox"/>	<input checked="" type="checkbox"/>	<input checked="" type="checkbox"/>	<input checked="" type="checkbox"/>	<input checked="" type="checkbox"/>	<input checked="" type="checkbox"/>	<input checked="" type="checkbox"/>	<input checked="" type="checkbox"/>	2
3	<input checked="" type="checkbox"/>	<input checked="" type="checkbox"/>	<input checked="" type="checkbox"/>	<input checked="" type="checkbox"/>	<input checked="" type="checkbox"/>	<input checked="" type="checkbox"/>	<input checked="" type="checkbox"/>	<input checked="" type="checkbox"/>	<input checked="" type="checkbox"/>	<input checked="" type="checkbox"/>	<input checked="" type="checkbox"/>	<input checked="" type="checkbox"/>	<input checked="" type="checkbox"/>	<input checked="" type="checkbox"/>	<input checked="" type="checkbox"/>	<input checked="" type="checkbox"/>	<input checked="" type="checkbox"/>	<input checked="" type="checkbox"/>	<input checked="" type="checkbox"/>	<input checked="" type="checkbox"/>	<input checked="" type="checkbox"/>	<input checked="" type="checkbox"/>	<input checked="" type="checkbox"/>	<input checked="" type="checkbox"/>	3
4	<input checked="" type="checkbox"/>	<input checked="" type="checkbox"/>	<input checked="" type="checkbox"/>	<input checked="" type="checkbox"/>	<input checked="" type="checkbox"/>	<input checked="" type="checkbox"/>	<input checked="" type="checkbox"/>	<input checked="" type="checkbox"/>	<input checked="" type="checkbox"/>	<input checked="" type="checkbox"/>	<input checked="" type="checkbox"/>	<input checked="" type="checkbox"/>	<input checked="" type="checkbox"/>	<input checked="" type="checkbox"/>	<input checked="" type="checkbox"/>	<input checked="" type="checkbox"/>	<input checked="" type="checkbox"/>	<input checked="" type="checkbox"/>	<input checked="" type="checkbox"/>	<input checked="" type="checkbox"/>	<input checked="" type="checkbox"/>	<input checked="" type="checkbox"/>	<input checked="" type="checkbox"/>	<input checked="" type="checkbox"/>	4
5	<input checked="" type="checkbox"/>	<input checked="" type="checkbox"/>	<input checked="" type="checkbox"/>	<input checked="" type="checkbox"/>	<input checked="" type="checkbox"/>	<input checked="" type="checkbox"/>	<input checked="" type="checkbox"/>	<input checked="" type="checkbox"/>	<input checked="" type="checkbox"/>	<input checked="" type="checkbox"/>	<input checked="" type="checkbox"/>	<input checked="" type="checkbox"/>	<input checked="" type="checkbox"/>	<input checked="" type="checkbox"/>	<input checked="" type="checkbox"/>	<input checked="" type="checkbox"/>	<input checked="" type="checkbox"/>	<input checked="" type="checkbox"/>	<input checked="" type="checkbox"/>	<input checked="" type="checkbox"/>	<input checked="" type="checkbox"/>	<input checked="" type="checkbox"/>	<input checked="" type="checkbox"/>	<input checked="" type="checkbox"/>	5
6	<input checked="" type="checkbox"/>	<input checked="" type="checkbox"/>	<input checked="" type="checkbox"/>	<input checked="" type="checkbox"/>	<input checked="" type="checkbox"/>	<input checked="" type="checkbox"/>	<input checked="" type="checkbox"/>	<input checked="" type="checkbox"/>	<input checked="" type="checkbox"/>	<input checked="" type="checkbox"/>	<input checked="" type="checkbox"/>	<input checked="" type="checkbox"/>	<input checked="" type="checkbox"/>	<input checked="" type="checkbox"/>	<input checked="" type="checkbox"/>	<input checked="" type="checkbox"/>	<input checked="" type="checkbox"/>	<input checked="" type="checkbox"/>	<input checked="" type="checkbox"/>	<input checked="" type="checkbox"/>	<input checked="" type="checkbox"/>	<input checked="" type="checkbox"/>	<input checked="" type="checkbox"/>	<input checked="" type="checkbox"/>	6
7	<input checked="" type="checkbox"/>	<input checked="" type="checkbox"/>	<input checked="" type="checkbox"/>	<input checked="" type="checkbox"/>	<input checked="" type="checkbox"/>	<input checked="" type="checkbox"/>	<input checked="" type="checkbox"/>	<input checked="" type="checkbox"/>	<input checked="" type="checkbox"/>	<input checked="" type="checkbox"/>	<input checked="" type="checkbox"/>	<input checked="" type="checkbox"/>	<input checked="" type="checkbox"/>	<input checked="" type="checkbox"/>	<input checked="" type="checkbox"/>	<input checked="" type="checkbox"/>	<input checked="" type="checkbox"/>	<input checked="" type="checkbox"/>	<input checked="" type="checkbox"/>	<input checked="" type="checkbox"/>	<input checked="" type="checkbox"/>	<input checked="" type="checkbox"/>	<input checked="" type="checkbox"/>	<input checked="" type="checkbox"/>	7
8	<input checked="" type="checkbox"/>	<input checked="" type="checkbox"/>	<input checked="" type="checkbox"/>	<input checked="" type="checkbox"/>	<input checked="" type="checkbox"/>	<input checked="" type="checkbox"/>	<input checked="" type="checkbox"/>	<input checked="" type="checkbox"/>	<input checked="" type="checkbox"/>	<input checked="" type="checkbox"/>	<input checked="" type="checkbox"/>	<input checked="" type="checkbox"/>	<input checked="" type="checkbox"/>	<input checked="" type="checkbox"/>	<input checked="" type="checkbox"/>	<input checked="" type="checkbox"/>	<input checked="" type="checkbox"/>	<input checked="" type="checkbox"/>	<input checked="" type="checkbox"/>	<input checked="" type="checkbox"/>	<input checked="" type="checkbox"/>	<input checked="" type="checkbox"/>	<input checked="" type="checkbox"/>	<input checked="" type="checkbox"/>	8
9	<input checked="" type="checkbox"/>	<input checked="" type="checkbox"/>	<input checked="" type="checkbox"/>	<input checked="" type="checkbox"/>	<input checked="" type="checkbox"/>	<input checked="" type="checkbox"/>	<input checked="" type="checkbox"/>	<input checked="" type="checkbox"/>	<input checked="" type="checkbox"/>	<input checked="" type="checkbox"/>	<input checked="" type="checkbox"/>	<input checked="" type="checkbox"/>	<input checked="" type="checkbox"/>	<input checked="" type="checkbox"/>	<input checked="" type="checkbox"/>	<input checked="" type="checkbox"/>	<input checked="" type="checkbox"/>	<input checked="" type="checkbox"/>	<input checked="" type="checkbox"/>	<input checked="" type="checkbox"/>	<input checked="" type="checkbox"/>	<input checked="" type="checkbox"/>	<input checked="" type="checkbox"/>	<input checked="" type="checkbox"/>	9
10	<input checked="" type="checkbox"/>	<input checked="" type="checkbox"/>	<input checked="" type="checkbox"/>	<input checked="" type="checkbox"/>	<input checked="" type="checkbox"/>	<input checked="" type="checkbox"/>	<input checked="" type="checkbox"/>	<input checked="" type="checkbox"/>	<input checked="" type="checkbox"/>	<input checked="" type="checkbox"/>	<input checked="" type="checkbox"/>	<input checked="" type="checkbox"/>	<input checked="" type="checkbox"/>	<input checked="" type="checkbox"/>	<input checked="" type="checkbox"/>	<input checked="" type="checkbox"/>	<input checked="" type="checkbox"/>	<input checked="" type="checkbox"/>	<input checked="" type="checkbox"/>	<input checked="" type="checkbox"/>	<input checked="" type="checkbox"/>	<input checked="" type="checkbox"/>	<input checked="" type="checkbox"/>	<input checked="" type="checkbox"/>	10
11	<input checked="" type="checkbox"/>	<input checked="" type="checkbox"/>	<input checked="" type="checkbox"/>	<input checked="" type="checkbox"/>	<input checked="" type="checkbox"/>	<input checked="" type="checkbox"/>	<input checked="" type="checkbox"/>	<input checked="" type="checkbox"/>	<input checked="" type="checkbox"/>	<input checked="" type="checkbox"/>	<input checked="" type="checkbox"/>	<input checked="" type="checkbox"/>	<input checked="" type="checkbox"/>	<input checked="" type="checkbox"/>	<input checked="" type="checkbox"/>	<input checked="" type="checkbox"/>	<input checked="" type="checkbox"/>	<input checked="" type="checkbox"/>	<input checked="" type="checkbox"/>	<input checked="" type="checkbox"/>	<input checked="" type="checkbox"/>	<input checked="" type="checkbox"/>	<input checked="" type="checkbox"/>	<input checked="" type="checkbox"/>	11
12	<input checked="" type="checkbox"/>	<input checked="" type="checkbox"/>	<input checked="" type="checkbox"/>	<input checked="" type="checkbox"/>	<input checked="" type="checkbox"/>	<input checked="" type="checkbox"/>	<input checked="" type="checkbox"/>	<input checked="" type="checkbox"/>	<input checked="" type="checkbox"/>	<input checked="" type="checkbox"/>	<input checked="" type="checkbox"/>	<input checked="" type="checkbox"/>	<input checked="" type="checkbox"/>	<input checked="" type="checkbox"/>	<input checked="" type="checkbox"/>	<input checked="" type="checkbox"/>	<input checked="" type="checkbox"/>	<input checked="" type="checkbox"/>	<input checked="" type="checkbox"/>	<input checked="" type="checkbox"/>	<input checked="" type="checkbox"/>	<input checked="" type="checkbox"/>	<input checked="" type="checkbox"/>	<input checked="" type="checkbox"/>	12
13	<input checked="" type="checkbox"/>	<input checked="" type="checkbox"/>	<input checked="" type="checkbox"/>	<input checked="" type="checkbox"/>	<input checked="" type="checkbox"/>	<input checked="" type="checkbox"/>	<input checked="" type="checkbox"/>	<input checked="" type="checkbox"/>	<input checked="" type="checkbox"/>	<input checked="" type="checkbox"/>	<input checked="" type="checkbox"/>	<input checked="" type="checkbox"/>	<input checked="" type="checkbox"/>	<input checked="" type="checkbox"/>	<input checked="" type="checkbox"/>	<input checked="" type="checkbox"/>	<input checked="" type="checkbox"/>	<input checked="" type="checkbox"/>	<input checked="" type="checkbox"/>	<input checked="" type="checkbox"/>	<input checked="" type="checkbox"/>	<input checked="" type="checkbox"/>	<input checked="" type="checkbox"/>	<input checked="" type="checkbox"/>	13
14	<input checked="" type="checkbox"/>	<input checked="" type="checkbox"/>	<input checked="" type="checkbox"/>	<input checked="" type="checkbox"/>	<input checked="" type="checkbox"/>	<input checked="" type="checkbox"/>	<input checked="" type="checkbox"/>	<input checked="" type="checkbox"/>	<input checked="" type="checkbox"/>	<input checked="" type="checkbox"/>	<input checked="" type="checkbox"/>	<input checked="" type="checkbox"/>	<input checked="" type="checkbox"/>	<input checked="" type="checkbox"/>	<input checked="" type="checkbox"/>	<input checked="" type="checkbox"/>	<input checked="" type="checkbox"/>	<input checked="" type="checkbox"/>	<input checked="" type="checkbox"/>	<input checked="" type="checkbox"/>	<input checked="" type="checkbox"/>	<input checked="" type="checkbox"/>	<input checked="" type="checkbox"/>	<input checked="" type="checkbox"/>	14
15	<input checked="" type="checkbox"/>	<input checked="" type="checkbox"/>	<input checked="" type="checkbox"/>	<input checked="" type="checkbox"/>	<input checked="" type="checkbox"/>	<input checked="" type="checkbox"/>	<input checked="" type="checkbox"/>	<input checked="" type="checkbox"/>	<input checked="" type="checkbox"/>	<input checked="" type="checkbox"/>	<input checked="" type="checkbox"/>	<input checked="" type="checkbox"/>	<input checked="" type="checkbox"/>	<input checked="" type="checkbox"/>	<input checked="" type="checkbox"/>	<input checked="" type="checkbox"/>	<input checked="" type="checkbox"/>	<input checked="" type="checkbox"/>	<input checked="" type="checkbox"/>	<input checked="" type="checkbox"/>	<input checked="" type="checkbox"/>	<input checked="" type="checkbox"/>	<input checked="" type="checkbox"/>	<input checked="" type="checkbox"/>	15
16	<input checked="" type="checkbox"/>	<input checked="" type="checkbox"/>	<input checked="" type="checkbox"/>	<input checked="" type="checkbox"/>	<input checked="" type="checkbox"/>	<input checked="" type="checkbox"/>	<input checked="" type="checkbox"/>	<input checked="" type="checkbox"/>	<input checked="" type="checkbox"/>	<input checked="" type="checkbox"/>	<input checked="" type="checkbox"/>	<input checked="" type="checkbox"/>	<input checked="" type="checkbox"/>	<input checked="" type="checkbox"/>	<input checked="" type="checkbox"/>	<input checked="" type="checkbox"/>	<input checked="" type="checkbox"/>	<input checked="" type="checkbox"/>	<input checked="" type="checkbox"/>	<input checked="" type="checkbox"/>	<input checked="" type="checkbox"/>	<input checked="" type="checkbox"/>	<input checked="" type="checkbox"/>	<input checked="" type="checkbox"/>	16
17	<input checked="" type="checkbox"/>	<input checked="" type="checkbox"/>	<input checked="" type="checkbox"/>	<input checked="" type="checkbox"/>	<input checked="" type="checkbox"/>	<input checked="" type="checkbox"/>	<input checked="" type="checkbox"/>	<input checked="" type="checkbox"/>	<input checked="" type="checkbox"/>	<input checked="" type="checkbox"/>	<input checked="" type="checkbox"/>	<input checked="" type="checkbox"/>	<input checked="" type="checkbox"/>	<input checked="" type="checkbox"/>	<input checked="" type="checkbox"/>	<input checked="" type="checkbox"/>	<input checked="" type="checkbox"/>	<input checked="" type="checkbox"/>	<input checked="" type="checkbox"/>	<input checked="" type="checkbox"/>	<input checked="" type="checkbox"/>	<input checked="" type="checkbox"/>	<input checked="" type="checkbox"/>	<input checked="" type="checkbox"/>	17
18	<input checked="" type="checkbox"/>	<input checked="" type="checkbox"/>	<input checked="" type="checkbox"/>	<input checked="" type="checkbox"/>	<input checked="" type="checkbox"/>	<input checked="" type="checkbox"/>	<input checked="" type="checkbox"/>	<input checked="" type="checkbox"/>	<input checked="" type="checkbox"/>	<input checked="" type="checkbox"/>	<input checked="" type="checkbox"/>	<input checked="" type="checkbox"/>	<input checked="" type="checkbox"/>	<input checked="" type="checkbox"/>	<input checked="" type="checkbox"/>	<input checked="" type="checkbox"/>	<input checked="" type="checkbox"/>	<input checked="" type="checkbox"/>	<input checked="" type="checkbox"/>	<input checked="" type="checkbox"/>	<input checked="" type="checkbox"/>	<input checked="" type="checkbox"/>	<input checked="" type="checkbox"/>	<input checked="" type="checkbox"/>	18
19	<input checked="" type="checkbox"/>	<input checked="" type="checkbox"/>	<input checked="" type="checkbox"/>	<input checked="" type="checkbox"/>	<input checked="" type="checkbox"/>	<input checked="" type="checkbox"/>	<input checked="" type="checkbox"/>	<input checked="" type="checkbox"/>	<input checked="" type="checkbox"/>	<input checked="" type="checkbox"/>	<input checked="" type="checkbox"/>	<input checked="" type="checkbox"/>	<input checked="" type="checkbox"/>	<input checked="" type="checkbox"/>	<input checked="" type="checkbox"/>	<input checked="" type="checkbox"/>	<input checked="" type="checkbox"/>	<input checked="" type="checkbox"/>	<input checked="" type="checkbox"/>	<input checked="" type="checkbox"/>	<input checked="" type="checkbox"/>	<input checked="" type="checkbox"/>	<input checked="" type="checkbox"/>	<input checked="" type="checkbox"/>	19
20	<input checked="" type="checkbox"/>	<input checked="" type="checkbox"/>	<input checked="" type="checkbox"/>	<input checked="" type="checkbox"/>	<input checked="" type="checkbox"/>	<input checked="" type="checkbox"/>	<input checked="" type="checkbox"/>	<input checked="" type="checkbox"/>	<input checked="" type="checkbox"/>	<input checked="" type="checkbox"/>	<input checked="" type="checkbox"/>	<input checked="" type="checkbox"/>	<input checked="" type="checkbox"/>	<input checked="" type="checkbox"/>	<input checked="" type="checkbox"/>	<input checked="" type="checkbox"/>	<input checked="" type="checkbox"/>	<input checked="" type="checkbox"/>	<input checked="" type="checkbox"/>	<input checked="" type="checkbox"/>	<input checked="" type="checkbox"/>	<input checked="" type="checkbox"/>	<input checked="" type="checkbox"/>	<input checked="" type="checkbox"/>	20
21	<input checked="" type="checkbox"/>	<input checked="" type="checkbox"/>	<input checked="" type="checkbox"/>	<input checked="" type="checkbox"/>	<input checked="" type="checkbox"/>	<input checked="" type="checkbox"/>	<input checked="" type="checkbox"/>	<input checked="" type="checkbox"/>	<input checked="" type="checkbox"/>	<input checked="" type="checkbox"/>	<input checked="" type="checkbox"/>	<input checked="" type="checkbox"/>	<input checked="" type="checkbox"/>	<input checked="" type="checkbox"/>	<input checked="" type="checkbox"/>	<input checked="" type="checkbox"/>	<input checked="" type="checkbox"/>	<input checked="" type="checkbox"/>	<input checked="" type="checkbox"/>	<input checked="" type="checkbox"/>	<input checked="" type="checkbox"/>	<input checked="" type="checkbox"/>	<input checked="" type="checkbox"/>	<input checked="" type="checkbox"/>	21
22	<input checked="" type="checkbox"/>	<input checked="" type="checkbox"/>	<input checked="" type="checkbox"/>	<input checked="" type="checkbox"/>	<input checked="" type="checkbox"/>	<input checked="" type="checkbox"/>	<input checked="" type="checkbox"/>	<input checked="" type="checkbox"/>	<input checked="" type="checkbox"/>	<input checked="" type="checkbox"/>	<input checked="" type="checkbox"/>	<input checked="" type="checkbox"/>	<input checked="" type="checkbox"/>	<input checked="" type="checkbox"/>	<input checked="" type="checkbox"/>	<input checked="" type="checkbox"/>	<input checked="" type="checkbox"/>	<input checked="" type="checkbox"/>	<input checked="" type="checkbox"/>	<input checked="" type="checkbox"/>	<input checked="" type="checkbox"/>	<input checked="" type="checkbox"/>	<input checked="" type="checkbox"/>	<input checked="" type="checkbox"/>	22
23	<input checked="" type="checkbox"/>	<input checked="" type="checkbox"/>	<input checked="" type="checkbox"/>	<input checked="" type="checkbox"/>	<input checked="" type="checkbox"/>	<input checked="" type="checkbox"/>	<input checked="" type="checkbox"/>	<input checked="" type="checkbox"/>	<input checked="" type="checkbox"/>	<input checked="" type="checkbox"/>	<input checked="" type="checkbox"/>	<input checked="" type="checkbox"/>	<input checked="" type="checkbox"/>	<input checked="" type="checkbox"/>	<input checked="" type="checkbox"/>	<input checked="" type="checkbox"/>	<input checked="" type="checkbox"/>	<input checked="" type="checkbox"/>	<input checked="" type="checkbox"/>	<input checked="" type="checkbox"/>	<input checked="" type="checkbox"/>	<input checked="" type="checkbox"/>	<input checked="" type="checkbox"/>	<input checked="" type="checkbox"/>	23
24	<input checked="" type="checkbox"/>	<input checked="" type="checkbox"/>	<input checked="" type="checkbox"/>	<input checked="" type="checkbox"/>	<input checked="" type="checkbox"/>	<input checked="" type="checkbox"/>	<input checked="" type="checkbox"/>	<input checked="" type="checkbox"/>	<input checked="" type="checkbox"/>	<input checked="" type="checkbox"/>	<input checked="" type="checkbox"/>	<input checked="" type="checkbox"/>	<input checked="" type="checkbox"/>	<input checked="" type="checkbox"/>	<input checked="" type="checkbox"/>	<input checked="" type="checkbox"/>	<input checked="" type="checkbox"/>	<input checked="" type="checkbox"/>	<input checked="" type="checkbox"/>	<input checked="" type="checkbox"/>	<input checked="" type="checkbox"/>	<input checked="" type="checkbox"/>	<input checked="" type="checkbox"/>	<input checked="" type="checkbox"/>	24
CPU	<input checked="" type="checkbox"/>	<input checked="" type="checkbox"/>	<input checked="" type="checkbox"/>	<input checked="" type="checkbox"/>	<input checked="" type="checkbox"/>	<input checked="" type="checkbox"/>	<input checked="" type="checkbox"/>	<input checked="" type="checkbox"/>	<input checked="" type="checkbox"/>	<input checked="" type="checkbox"/>	<input checked="" type="checkbox"/>	<input checked="" type="checkbox"/>	<input checked="" type="checkbox"/>	<input checked="" type="checkbox"/>	<input checked="" type="checkbox"/>	<input checked="" type="checkbox"/>	<input checked="" type="checkbox"/>	<input checked="" type="checkbox"/>	<input checked="" type="checkbox"/>	<input checked="" type="checkbox"/>	<input checked="" type="checkbox"/>	<input checked="" type="checkbox"/>	<input checked="" type="checkbox"/>	<input checked="" type="checkbox"/>	CPU

Outgoing

Apply Cancel

Figure 40 Port Based VLAN Setup (Port Isolation)

Port Based VLAN Setup

Setting Wizard | Port isolation | Apply

Incoming

	1	2	3	4	5	6	7	8	9	10	11	12	13	14	15	16	17	18	19	20	21	22	23	24	
1	<input checked="" type="checkbox"/>	<input type="checkbox"/>	<input type="checkbox"/>	<input type="checkbox"/>	<input type="checkbox"/>	<input type="checkbox"/>	<input type="checkbox"/>	<input type="checkbox"/>	<input type="checkbox"/>	<input type="checkbox"/>	<input type="checkbox"/>	<input type="checkbox"/>	<input type="checkbox"/>	<input type="checkbox"/>	<input type="checkbox"/>	<input type="checkbox"/>	<input type="checkbox"/>	<input type="checkbox"/>	<input type="checkbox"/>	<input type="checkbox"/>	<input type="checkbox"/>	<input type="checkbox"/>	<input type="checkbox"/>	<input type="checkbox"/>	1
2	<input type="checkbox"/>	<input checked="" type="checkbox"/>	<input type="checkbox"/>	<input type="checkbox"/>	<input type="checkbox"/>	<input type="checkbox"/>	<input type="checkbox"/>	<input type="checkbox"/>	<input type="checkbox"/>	<input type="checkbox"/>	<input type="checkbox"/>	<input type="checkbox"/>	<input type="checkbox"/>	<input type="checkbox"/>	<input type="checkbox"/>	<input type="checkbox"/>	<input type="checkbox"/>	<input type="checkbox"/>	<input type="checkbox"/>	<input type="checkbox"/>	<input type="checkbox"/>	<input type="checkbox"/>	<input type="checkbox"/>	<input type="checkbox"/>	2
3	<input type="checkbox"/>	<input type="checkbox"/>	<input checked="" type="checkbox"/>	<input type="checkbox"/>	<input type="checkbox"/>	<input type="checkbox"/>	<input type="checkbox"/>	<input type="checkbox"/>	<input type="checkbox"/>	<input type="checkbox"/>	<input type="checkbox"/>	<input type="checkbox"/>	<input type="checkbox"/>	<input type="checkbox"/>	<input type="checkbox"/>	<input type="checkbox"/>	<input type="checkbox"/>	<input type="checkbox"/>	<input type="checkbox"/>	<input type="checkbox"/>	<input type="checkbox"/>	<input type="checkbox"/>	<input type="checkbox"/>	<input type="checkbox"/>	3
4	<input type="checkbox"/>	<input type="checkbox"/>	<input type="checkbox"/>	<input checked="" type="checkbox"/>	<input type="checkbox"/>	<input type="checkbox"/>	<input type="checkbox"/>	<input type="checkbox"/>	<input type="checkbox"/>	<input type="checkbox"/>	<input type="checkbox"/>	<input type="checkbox"/>	<input type="checkbox"/>	<input type="checkbox"/>	<input type="checkbox"/>	<input type="checkbox"/>	<input type="checkbox"/>	<input type="checkbox"/>	<input type="checkbox"/>	<input type="checkbox"/>	<input type="checkbox"/>	<input type="checkbox"/>	<input type="checkbox"/>	<input type="checkbox"/>	4
5	<input type="checkbox"/>	<input type="checkbox"/>	<input type="checkbox"/>	<input type="checkbox"/>	<input checked="" type="checkbox"/>	<input type="checkbox"/>	<input type="checkbox"/>	<input type="checkbox"/>	<input type="checkbox"/>	<input type="checkbox"/>	<input type="checkbox"/>	<input type="checkbox"/>	<input type="checkbox"/>	<input type="checkbox"/>	<input type="checkbox"/>	<input type="checkbox"/>	<input type="checkbox"/>	<input type="checkbox"/>	<input type="checkbox"/>	<input type="checkbox"/>	<input type="checkbox"/>	<input type="checkbox"/>	<input type="checkbox"/>	<input type="checkbox"/>	5
6	<input type="checkbox"/>	<input type="checkbox"/>	<input type="checkbox"/>	<input type="checkbox"/>	<input type="checkbox"/>	<input checked="" type="checkbox"/>	<input type="checkbox"/>	<input type="checkbox"/>	<input type="checkbox"/>	<input type="checkbox"/>	<input type="checkbox"/>	<input type="checkbox"/>	<input type="checkbox"/>	<input type="checkbox"/>	<input type="checkbox"/>	<input type="checkbox"/>	<input type="checkbox"/>	<input type="checkbox"/>	<input type="checkbox"/>	<input type="checkbox"/>	<input type="checkbox"/>	<input type="checkbox"/>	<input type="checkbox"/>	<input type="checkbox"/>	6
7	<input type="checkbox"/>	<input type="checkbox"/>	<input type="checkbox"/>	<input type="checkbox"/>	<input type="checkbox"/>	<input type="checkbox"/>	<input checked="" type="checkbox"/>	<input type="checkbox"/>	<input type="checkbox"/>	<input type="checkbox"/>	<input type="checkbox"/>	<input type="checkbox"/>	<input type="checkbox"/>	<input type="checkbox"/>	<input type="checkbox"/>	<input type="checkbox"/>	<input type="checkbox"/>	<input type="checkbox"/>	<input type="checkbox"/>	<input type="checkbox"/>	<input type="checkbox"/>	<input type="checkbox"/>	<input type="checkbox"/>	<input type="checkbox"/>	7
8	<input type="checkbox"/>	<input type="checkbox"/>	<input type="checkbox"/>	<input type="checkbox"/>	<input type="checkbox"/>	<input type="checkbox"/>	<input type="checkbox"/>	<input checked="" type="checkbox"/>	<input type="checkbox"/>	<input type="checkbox"/>	<input type="checkbox"/>	<input type="checkbox"/>	<input type="checkbox"/>	<input type="checkbox"/>	<input type="checkbox"/>	<input type="checkbox"/>	<input type="checkbox"/>	<input type="checkbox"/>	<input type="checkbox"/>	<input type="checkbox"/>	<input type="checkbox"/>	<input type="checkbox"/>	<input type="checkbox"/>	<input type="checkbox"/>	8
9	<input type="checkbox"/>	<input type="checkbox"/>	<input type="checkbox"/>	<input type="checkbox"/>	<input type="checkbox"/>	<input type="checkbox"/>	<input type="checkbox"/>	<input type="checkbox"/>	<input checked="" type="checkbox"/>	<input type="checkbox"/>	<input type="checkbox"/>	<input type="checkbox"/>	<input type="checkbox"/>	<input type="checkbox"/>	<input type="checkbox"/>	<input type="checkbox"/>	<input type="checkbox"/>	<input type="checkbox"/>	<input type="checkbox"/>	<input type="checkbox"/>	<input type="checkbox"/>	<input type="checkbox"/>	<input type="checkbox"/>	<input type="checkbox"/>	9
10	<input type="checkbox"/>	<input type="checkbox"/>	<input type="checkbox"/>	<input type="checkbox"/>	<input type="checkbox"/>	<input type="checkbox"/>	<input type="checkbox"/>	<input type="checkbox"/>	<input type="checkbox"/>	<input checked="" type="checkbox"/>	<input type="checkbox"/>	<input type="checkbox"/>	<input type="checkbox"/>	<input type="checkbox"/>	<input type="checkbox"/>	<input type="checkbox"/>	<input type="checkbox"/>	<input type="checkbox"/>	<input type="checkbox"/>	<input type="checkbox"/>	<input type="checkbox"/>	<input type="checkbox"/>	<input type="checkbox"/>	<input type="checkbox"/>	10
11	<input type="checkbox"/>	<input type="checkbox"/>	<input type="checkbox"/>	<input type="checkbox"/>	<input type="checkbox"/>	<input type="checkbox"/>	<input type="checkbox"/>	<input type="checkbox"/>	<input type="checkbox"/>	<input type="checkbox"/>	<input checked="" type="checkbox"/>	<input type="checkbox"/>	<input type="checkbox"/>	<input type="checkbox"/>	<input type="checkbox"/>	<input type="checkbox"/>	<input type="checkbox"/>	<input type="checkbox"/>	<input type="checkbox"/>	<input type="checkbox"/>	<input type="checkbox"/>	<input type="checkbox"/>	<input type="checkbox"/>	<input type="checkbox"/>	11
12	<input type="checkbox"/>	<input type="checkbox"/>	<input type="checkbox"/>	<input type="checkbox"/>	<input type="checkbox"/>	<input type="checkbox"/>	<input type="checkbox"/>	<input type="checkbox"/>	<input type="checkbox"/>	<input type="checkbox"/>	<input type="checkbox"/>	<input checked="" type="checkbox"/>	<input type="checkbox"/>	<input type="checkbox"/>	<input type="checkbox"/>	<input type="checkbox"/>	<input type="checkbox"/>	<input type="checkbox"/>	<input type="checkbox"/>	<input type="checkbox"/>	<input type="checkbox"/>	<input type="checkbox"/>	<input type="checkbox"/>	<input type="checkbox"/>	12
13	<input type="checkbox"/>	<input type="checkbox"/>	<input type="checkbox"/>	<input type="checkbox"/>	<input type="checkbox"/>	<input type="checkbox"/>	<input type="checkbox"/>	<input type="checkbox"/>	<input type="checkbox"/>	<input type="checkbox"/>	<input type="checkbox"/>	<input type="checkbox"/>	<input checked="" type="checkbox"/>	<input type="checkbox"/>	<input type="checkbox"/>	<input type="checkbox"/>	<input type="checkbox"/>	<input type="checkbox"/>	<input type="checkbox"/>	<input type="checkbox"/>	<input type="checkbox"/>	<input type="checkbox"/>	<input type="checkbox"/>	<input type="checkbox"/>	13
14	<input type="checkbox"/>	<input type="checkbox"/>	<input type="checkbox"/>	<input type="checkbox"/>	<input type="checkbox"/>	<input type="checkbox"/>	<input type="checkbox"/>	<input type="checkbox"/>	<input type="checkbox"/>	<input type="checkbox"/>	<input type="checkbox"/>	<input type="checkbox"/>	<input type="checkbox"/>	<input checked="" type="checkbox"/>	<input type="checkbox"/>	<input type="checkbox"/>	<input type="checkbox"/>	<input type="checkbox"/>	<input type="checkbox"/>	<input type="checkbox"/>	<input type="checkbox"/>	<input type="checkbox"/>	<input type="checkbox"/>	<input type="checkbox"/>	14
15	<input type="checkbox"/>	<input type="checkbox"/>	<input type="checkbox"/>	<input type="checkbox"/>	<input type="checkbox"/>	<input type="checkbox"/>	<input type="checkbox"/>	<input type="checkbox"/>	<input type="checkbox"/>	<input type="checkbox"/>	<input type="checkbox"/>	<input type="checkbox"/>	<input type="checkbox"/>	<input type="checkbox"/>	<input checked="" type="checkbox"/>	<input type="checkbox"/>	<input type="checkbox"/>	<input type="checkbox"/>	<input type="checkbox"/>	<input type="checkbox"/>	<input type="checkbox"/>	<input type="checkbox"/>	<input type="checkbox"/>	<input type="checkbox"/>	15
16	<input type="checkbox"/>	<input type="checkbox"/>	<input type="checkbox"/>	<input type="checkbox"/>	<input type="checkbox"/>	<input type="checkbox"/>	<input type="checkbox"/>	<input type="checkbox"/>	<input type="checkbox"/>	<input type="checkbox"/>	<input type="checkbox"/>	<input type="checkbox"/>	<input type="checkbox"/>	<input type="checkbox"/>	<input type="checkbox"/>	<input checked="" type="checkbox"/>	<input type="checkbox"/>	<input type="checkbox"/>	<input type="checkbox"/>	<input type="checkbox"/>	<input type="checkbox"/>	<input type="checkbox"/>	<input type="checkbox"/>	<input type="checkbox"/>	16
17	<input type="checkbox"/>	<input type="checkbox"/>	<input type="checkbox"/>	<input type="checkbox"/>	<input type="checkbox"/>	<input type="checkbox"/>	<input type="checkbox"/>	<input type="checkbox"/>	<input type="checkbox"/>	<input type="checkbox"/>	<input type="checkbox"/>	<input type="checkbox"/>	<input type="checkbox"/>	<input type="checkbox"/>	<input type="checkbox"/>	<input type="checkbox"/>	<input checked="" type="checkbox"/>	<input type="checkbox"/>	<input type="checkbox"/>	<input type="checkbox"/>	<input type="checkbox"/>	<input type="checkbox"/>	<input type="checkbox"/>	<input type="checkbox"/>	17
18	<input type="checkbox"/>	<input type="checkbox"/>	<input type="checkbox"/>	<input type="checkbox"/>	<input type="checkbox"/>	<input type="checkbox"/>	<input type="checkbox"/>	<input type="checkbox"/>	<input type="checkbox"/>	<input type="checkbox"/>	<input type="checkbox"/>	<input type="checkbox"/>	<input type="checkbox"/>	<input type="checkbox"/>	<input type="checkbox"/>	<input type="checkbox"/>	<input type="checkbox"/>	<input checked="" type="checkbox"/>	<input type="checkbox"/>	<input type="checkbox"/>	<input type="checkbox"/>	<input type="checkbox"/>	<input type="checkbox"/>	<input type="checkbox"/>	18
19	<input type="checkbox"/>	<input type="checkbox"/>	<input type="checkbox"/>	<input type="checkbox"/>	<input type="checkbox"/>	<input type="checkbox"/>	<input type="checkbox"/>	<input type="checkbox"/>	<input type="checkbox"/>	<input type="checkbox"/>	<input type="checkbox"/>	<input type="checkbox"/>	<input type="checkbox"/>	<input type="checkbox"/>	<input type="checkbox"/>	<input type="checkbox"/>	<input type="checkbox"/>	<input type="checkbox"/>	<input checked="" type="checkbox"/>	<input type="checkbox"/>	<input type="checkbox"/>	<input type="checkbox"/>	<input type="checkbox"/>	<input type="checkbox"/>	19
20	<input type="checkbox"/>	<input type="checkbox"/>	<input type="checkbox"/>	<input type="checkbox"/>	<input type="checkbox"/>	<input type="checkbox"/>	<input type="checkbox"/>	<input type="checkbox"/>	<input type="checkbox"/>	<input type="checkbox"/>	<input type="checkbox"/>	<input type="checkbox"/>	<input type="checkbox"/>	<input type="checkbox"/>	<input type="checkbox"/>	<input type="checkbox"/>	<input type="checkbox"/>	<input type="checkbox"/>	<input type="checkbox"/>	<input checked="" type="checkbox"/>	<input type="checkbox"/>	<input type="checkbox"/>	<input type="checkbox"/>	<input type="checkbox"/>	20
21	<input type="checkbox"/>	<input type="checkbox"/>	<input type="checkbox"/>	<input type="checkbox"/>	<input type="checkbox"/>	<input type="checkbox"/>	<input type="checkbox"/>	<input type="checkbox"/>	<input type="checkbox"/>	<input type="checkbox"/>	<input type="checkbox"/>	<input type="checkbox"/>	<input type="checkbox"/>	<input type="checkbox"/>	<input type="checkbox"/>	<input type="checkbox"/>	<input type="checkbox"/>	<input type="checkbox"/>	<input type="checkbox"/>	<input type="checkbox"/>	<input checked="" type="checkbox"/>	<input type="checkbox"/>	<input type="checkbox"/>	<input type="checkbox"/>	21
22	<input type="checkbox"/>	<input type="checkbox"/>	<input type="checkbox"/>	<input type="checkbox"/>	<input type="checkbox"/>	<input type="checkbox"/>	<input type="checkbox"/>	<input type="checkbox"/>	<input type="checkbox"/>	<input type="checkbox"/>	<input type="checkbox"/>	<input type="checkbox"/>	<input type="checkbox"/>	<input type="checkbox"/>	<input type="checkbox"/>	<input type="checkbox"/>	<input type="checkbox"/>	<input type="checkbox"/>	<input type="checkbox"/>	<input type="checkbox"/>	<input type="checkbox"/>	<input checked="" type="checkbox"/>	<input type="checkbox"/>	<input type="checkbox"/>	22
23	<input type="checkbox"/>	<input type="checkbox"/>	<input type="checkbox"/>	<input type="checkbox"/>	<input type="checkbox"/>	<input type="checkbox"/>	<input type="checkbox"/>	<input type="checkbox"/>	<input type="checkbox"/>	<input type="checkbox"/>	<input type="checkbox"/>	<input type="checkbox"/>	<input type="checkbox"/>	<input type="checkbox"/>	<input type="checkbox"/>	<input type="checkbox"/>	<input type="checkbox"/>	<input type="checkbox"/>	<input type="checkbox"/>	<input type="checkbox"/>	<input type="checkbox"/>	<input type="checkbox"/>	<input checked="" type="checkbox"/>	<input type="checkbox"/>	23
24	<input type="checkbox"/>	<input type="checkbox"/>	<input type="checkbox"/>	<input type="checkbox"/>	<input type="checkbox"/>	<input type="checkbox"/>	<input type="checkbox"/>	<input type="checkbox"/>	<input type="checkbox"/>	<input type="checkbox"/>	<input type="checkbox"/>	<input type="checkbox"/>	<input type="checkbox"/>	<input type="checkbox"/>	<input type="checkbox"/>	<input type="checkbox"/>	<input type="checkbox"/>	<input type="checkbox"/>	<input type="checkbox"/>	<input type="checkbox"/>	<input type="checkbox"/>	<input type="checkbox"/>	<input type="checkbox"/>	<input checked="" type="checkbox"/>	24
CPU	<input checked="" type="checkbox"/>	<input checked="" type="checkbox"/>	<input checked="" type="checkbox"/>	<input checked="" type="checkbox"/>	<input checked="" type="checkbox"/>	<input checked="" type="checkbox"/>	<input checked="" type="checkbox"/>	<input checked="" type="checkbox"/>	<input checked="" type="checkbox"/>	<input checked="" type="checkbox"/>	<input checked="" type="checkbox"/>	<input checked="" type="checkbox"/>	<input checked="" type="checkbox"/>	<input checked="" type="checkbox"/>	<input checked="" type="checkbox"/>	<input checked="" type="checkbox"/>	<input checked="" type="checkbox"/>	<input checked="" type="checkbox"/>	<input checked="" type="checkbox"/>	<input checked="" type="checkbox"/>	<input checked="" type="checkbox"/>	<input checked="" type="checkbox"/>	<input checked="" type="checkbox"/>	<input checked="" type="checkbox"/>	CPU
	1	2	3	4	5	6	7	8	9	10	11	12	13	14	15	16	17	18	19	20	21	22	23	24	

Outgoing

Apply | Cancel

The following table describes the labels in this screen.

Table 18 Port Based VLAN Setup

LABEL	DESCRIPTION
Setting Wizard	<p>Choose All connected or Port isolation.</p> <p>All connected means all ports can communicate with each other, that is, there are no virtual LANs. All incoming and outgoing ports are selected. This option is the most flexible but also the least secure.</p> <p>Port isolation means that each port can only communicate with the CPU management port and cannot communicate with each other. All incoming ports are selected while only the CPU outgoing port is selected. This option is the most limiting but also the most secure.</p> <p>After you make your selection, click Apply (top right of screen) to display the screens as mentioned above. You can still customize these settings by adding/deleting incoming or outgoing ports, but you must also click Apply at the bottom of the screen.</p>
Incoming	<p>These are the ingress ports; an ingress port is an incoming port, that is, a port through which a data packet enters. If you wish to allow two subscriber ports to talk to each other, you must define the ingress port for both ports. The numbers in the top row denote the incoming port for the corresponding port listed on the left (its outgoing port). CPU refers to the switch management port. By default it forms a VLAN with all Ethernet ports. If it does not form a VLAN with a particular port then the switch cannot be managed from that port.</p>
Outgoing	<p>These are the egress ports; an egress port is an outgoing port, that is, a port through which a data packet leaves. If you wish to allow two subscriber ports to talk to each other, you must define the egress port for both ports. CPU refers to the switch management port. By default it forms a VLAN with all Ethernet ports. If it does not form a VLAN with a particular port then the switch cannot be managed from that port.</p>
Apply	<p>Click Apply to save your changes to the switch's run-time memory. The switch loses these changes if it is turned off or loses power, so use the Save link on the top navigation panel to save your changes to the non-volatile memory when you are done configuring.</p>
Cancel	<p>Click Cancel to reset the fields.</p>

CHAPTER 9

Static MAC Forward Setup

Use these screens to configure static MAC address forwarding.

9.1 Overview

This chapter discusses how to configure forwarding rules based on MAC addresses of devices on your network.

9.2 Configuring Static MAC Forwarding

A static MAC address is an address that has been manually entered in the MAC address table. Static MAC addresses do not age out. When you set up static MAC address rules, you are setting static MAC addresses for a port. This may reduce the need for broadcasting.

Static MAC address forwarding together with port security allow only computers in the MAC address table on a port to access the switch. See [Chapter 17 on page 125](#) for more information on port security.

Click **Advanced Applications, Static MAC Forwarding** in the navigation panel to display the configuration screen as shown.

Figure 41 Static MAC Forwarding

The following table describes the labels in this screen.

Table 19 Static MAC Forwarding

LABEL	DESCRIPTION
Active	Select this check box to activate your rule. You may temporarily deactivate a rule without deleting it by clearing this check box.
Name	Enter a descriptive name for identification purposes for this static MAC address forwarding rule.
MAC Address	Enter the MAC address in valid MAC address format, that is, six hexadecimal character pairs. Note: Static MAC addresses do not age out.
VID	Enter the VLAN identification number.
Port	Enter the port where the MAC address entered in the previous field will be automatically forwarded.
Add	Click Add to save your rule to the switch's run-time memory. The switch loses this rule if it is turned off or loses power, so use the Save link on the top navigation panel to save your changes to the non-volatile memory when you are done configuring.
Cancel	Click Cancel to reset the fields.
Clear	Click Clear to begin configuring this screen afresh.
Index	Click an index number to modify a static MAC address rule for a port.
Active	This field displays whether this static MAC address forwarding rule is active (Yes) or not (No). You may temporarily deactivate a rule without deleting it.
Name	This field displays the descriptive name for identification purposes for this static MAC address-forwarding rule.
MAC Address	This field displays the MAC address that will be forwarded and the VLAN identification number to which the MAC address belongs.
VID	This field displays the ID number of the VLAN group.
Port	This field displays the port where the MAC address shown in the next field will be forwarded.
Delete	Click Delete to remove the selected entry from the summary table.
Cancel	Click Cancel to clear the Delete check boxes.

CHAPTER 10

Filtering

This chapter discusses MAC address port filtering.

10.1 Configure a Filtering Rule

Filtering means sifting traffic going through the switch based on the source and/or destination MAC addresses and VLAN group (ID).

Click **Advanced Application** and **Filtering** in the navigation panel to display the screen as shown next.

Figure 42 Filtering

The following table describes the related labels in this screen.

Table 20 Filtering

LABEL	DESCRIPTION
Active	Make sure to select this check box to activate your rule. You may temporarily deactivate a rule without deleting it by deselecting this check box.
Name	Type a descriptive name (up to 32 printable ASCII characters) for this rule. This is for identification only.

Table 20 Filtering (continued)

LABEL	DESCRIPTION
Action	<p>Select Discard source to drop frame from the source MAC address (specified in the MAC field). The switch can still send frames to the MAC address.</p> <p>Select Discard destination to drop frames to the destination MAC address (specified in the MAC address). The switch can still receive frames originating from the MAC address.</p> <p>Select Discard source and Discard destination to block traffic to/from the MAC address specified in the MAC field.</p>
MAC	Type a MAC address in valid MAC address format, that is, six hexadecimal character pairs.
VID	Type the VLAN group identification number.
Add	Click Add to save your changes to the switch's run-time memory. The switch loses these changes if it is turned off or loses power, so use the Save link on the top navigation panel to save your changes to the non-volatile memory when you are done configuring.
Cancel	Click Cancel to reset the fields to your previous configuration.
Clear	Click Clear to clear the fields to the factory defaults.
Index	This field displays the index number of the rule. Click an index number to change the settings.
Active	This field displays Yes when the rule is activated and No when is it deactivated.
Name	This field displays the descriptive name for this rule. This is for identification purpose only.
MAC Address	This field displays the source/destination MAC address with the VLAN identification number to which the MAC address belongs.
VID	This field displays the VLAN group identification number.
Delete	Check the rule(s) that you want to remove in the Delete column and then click the Delete button.
Cancel	Click Cancel to clear the selected checkbox(es) in the Delete column.

CHAPTER 11

Spanning Tree Protocol

The switch supports Spanning Tree Protocol (STP) and Rapid Spanning Tree Protocol (RSTP) as defined in the following standards.

- IEEE 802.1D Spanning Tree Protocol
- IEEE 802.1w Rapid Spanning Tree Protocol

The switch also allows you to set up multiple STP configurations (or trees). Ports can then be assigned to the trees.

11.1 STP/RSTP Overview

(R)STP detects and breaks network loops and provides backup links between switches, bridges or routers. It allows a switch to interact with other (R)STP -compliant switches in your network to ensure that only one path exists between any two stations on the network.

The switch uses IEEE 802.1w RSTP (Rapid Spanning Tree Protocol) that allows faster convergence of the spanning tree than STP (while also being backwards compatible with STP-only aware bridges). In RSTP, topology change information is directly propagated throughout the network from the device that generates the topology change. In STP, a longer delay is required as the device that causes a topology change first notifies the root bridge that then notifies the network. Both RSTP and STP flush unwanted learned addresses from the filtering database. In RSTP, the port states are Discarding, Learning, and Forwarding.

Note: In this user's guide, "STP" refers to both STP and RSTP.

11.1.1 STP Terminology

The root bridge is the base of the spanning tree.

Path cost is the cost of transmitting a frame onto a LAN through that port. It is assigned according to the speed of the link to which a port is attached. The slower the media, the higher the cost.

Table 21 STP Path Costs

	LINK SPEED	RECOMMENDED VALUE	RECOMMENDED RANGE	ALLOWED RANGE
Path Cost	4Mbps	250	100 to 1000	1 to 65535
Path Cost	10Mbps	100	50 to 600	1 to 65535

Table 21 STP Path Costs

	LINK SPEED	RECOMMENDED VALUE	RECOMMENDED RANGE	ALLOWED RANGE
Path Cost	16Mbps	62	40 to 400	1 to 65535
Path Cost	100Mbps	19	10 to 60	1 to 65535
Path Cost	1Gbps	4	3 to 10	1 to 65535
Path Cost	10Gbps	2	1 to 5	1 to 65535

On each bridge, the root port is the port through which this bridge communicates with the root. It is the port on this switch with the lowest path cost to the root (the root path cost). If there is no root port, then this switch has been accepted as the root bridge of the spanning tree network.

For each LAN segment, a designated bridge is selected. This bridge has the lowest cost to the root among the bridges connected to the LAN.

11.1.2 How STP Works

After a bridge determines the lowest cost-spanning tree with STP, it enables the root port and the ports that are the designated ports for connected LANs, and disables all other ports that participate in STP. Network packets are therefore only forwarded between enabled ports, eliminating any possible network loops.

STP-aware switches exchange Bridge Protocol Data Units (BPDUs) periodically. When the bridged LAN topology changes, a new spanning tree is constructed.

Once a stable network topology has been established, all bridges listen for Hello BPDUs (Bridge Protocol Data Units) transmitted from the root bridge. If a bridge does not get a Hello BPDUs after a predefined interval (Max Age), the bridge assumes that the link to the root bridge is down. This bridge then initiates negotiations with other bridges to reconfigure the network to re-establish a valid network topology.

11.1.3 STP Port States

STP assigns five port states to eliminate packet looping. A bridge port is not allowed to go directly from blocking state to forwarding state so as to eliminate transient loops.

Table 22 STP Port States

PORT STATE	DESCRIPTION
Disabled	STP is disabled (default).
Blocking	Only configuration and management BPDUs are received and processed.
Listening	All BPDUs are received and processed.

Table 22 STP Port States

PORT STATE	DESCRIPTION
Learning	All BPDUs are received and processed. Information frames are submitted to the learning process but not forwarded.
Forwarding	All BPDUs are received and processed. All information frames are received and forwarded.

11.1.4 Multiple RSTP

MRSTP (Multiple RSTP) is ZyXEL's proprietary feature that is compatible with RSTP and STP. With MRSTP, you can have more than one spanning tree on your switch and assign port(s) to each tree. Each spanning tree operates independently with its own bridge information.

In the following example, there are two RSTP instances (**MRSTP 1** and **MRSTP2**) on switch **A**.

To set up MRSTP, activate MRSTP on the switch and specify which port(s) belong to which spanning tree.

Note: Each port can belong to one STP tree only.

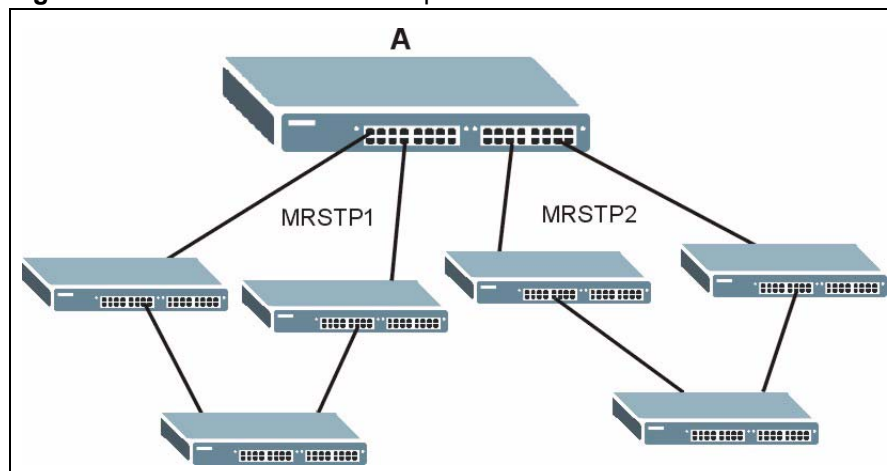
Figure 43 MRSTP Network Example

11.2 Spanning Tree Protocol Main Screen

The switch allows you to configure a single RSTP configuration or you can configure multiple configurations. See [Section 11.1 on page 97](#) for more information on RSTP. Click **Advanced Application, Spanning Tree Protocol** in the navigation panel to choose whether you want to configure multiple or a single Spanning Tree Protocol configuration.

Note: This screen is only available if neither RSTP or MRSTP is active. Once you select RSTP or MRSTP this screen displays the status of your configuration.

Figure 44 Spanning Tree Protocol RSTP and MRSTP

The following table describes the labels in this screen.

Table 23 Spanning Tree Protocol: Status

LABEL	DESCRIPTION
RSTP	This link takes you to the Rapid Spanning Tree Protocol configuration screen. See Section 11.3 on page 100 .
MRSTP	This link takes you to the Multiple Rapid Spanning Tree Protocol configuration screen. See Section 11.5 on page 103 .

11.3 Configure Rapid Spanning Tree Protocol

Use this screen to configure RSTP settings, see [Section 11.1 on page 97](#) for more information on RSTP. Click **RSTP** in the **Advanced Application, Spanning Tree Protocol** screen.

Figure 45 RSTP: Configuration

Port	Active	Priority	Path Cost
*	<input type="checkbox"/>		
1	<input type="checkbox"/>	128	4
2	<input type="checkbox"/>	128	4
3	<input type="checkbox"/>	128	4
4	<input type="checkbox"/>	128	4
5	<input type="checkbox"/>	128	4
6	<input type="checkbox"/>	128	4
7	<input type="checkbox"/>	128	4
8	<input type="checkbox"/>	128	4

The following table describes the labels in this screen.

Table 24 RSTP: Configuration

LABEL	DESCRIPTION
Status	Click Status to display the RSTP Status screen (see Figure 46 on page 103).
Active	Select this check box to activate RSTP. Clear this checkbox to disable RSTP.
Bridge Priority	<p>Bridge priority is used in determining the root switch, root port and designated port. The switch with the highest priority (lowest numeric value) becomes the STP root switch. If all switches have the same priority, the switch with the lowest MAC address will then become the root switch. Select a value from the drop-down list box.</p> <p>The lower the numeric value you assign, the higher the priority for this bridge.</p> <p>Bridge Priority determines the root bridge, which in turn determines Hello Time, Max Age and Forwarding Delay.</p>
Hello Time	This is the time interval in seconds between BPDU (Bridge Protocol Data Units) configuration message generations by the root switch. The allowed range is 1 to 10 seconds.
Max Age	This is the maximum time (in seconds) a switch can wait without receiving a BPDU before attempting to reconfigure. All switch ports (except for designated ports) should receive BPDUs at regular intervals. Any port that ages out STP information (provided in the last BPDU) becomes the designated port for the attached LAN. If it is a root port, a new root port is selected from among the switch ports attached to the network. The allowed range is 6 to 40 seconds.

Table 24 RSTP: Configuration (continued)

LABEL	DESCRIPTION
Forwarding Delay	<p>This is the maximum time (in seconds) a switch will wait before changing states. This delay is required because every switch must receive information about topology changes before it starts to forward frames. In addition, each port needs time to listen for conflicting information that would make it return to a blocking state; otherwise, temporary data loops might result. The allowed range is 4 to 30 seconds.</p> <p>As a general rule:</p> <p>Note: $2 * (\text{Forward Delay} - 1) \geq \text{Max Age} \geq 2 * (\text{Hello Time} + 1)$</p>
Port	This field displays the port number.
*	<p>Settings in this row apply to all ports.</p> <p>Use this row only if you want to make some settings the same for all ports. Use this row first to set the common settings and then make adjustments on a port-by-port basis.</p> <p>Note: Changes in this row are copied to all the ports as soon as you make them.</p>
Active	Select this check box to activate RSTP on this port.
Priority	<p>Configure the priority for each port here.</p> <p>Priority decides which port should be disabled when more than one port forms a loop in a switch. Ports with a higher priority numeric value are disabled first. The allowed range is between 0 and 255.</p>
Path Cost	Path cost is the cost of transmitting a frame on to a LAN through that port. It is assigned according to the speed of the bridge. The slower the media, the higher the cost - see Table 21 on page 97 for more information.
Apply	Click Apply to save your changes to the switch's run-time memory. The switch loses these changes if it is turned off or loses power, so use the Save link on the top navigation panel to save your changes to the non-volatile memory when you are done configuring.
Cancel	Click Cancel to reset the fields.

11.4 Rapid Spanning Tree Protocol Status

Click **Advanced Application, Spanning Tree Protocol** in the navigation panel to display the status screen as shown next. See [Section 11.1 on page 97](#) for more information on RSTP.

Note: This screen is only available after you activate RSTP on the switch.

Figure 46 Rapid Spanning Tree Protocol: Status

Bridge	Root	Our Bridge
Bridge ID	8000-0013496ad187	8000-0013496ad187
Hello Time (second)	2	2
Max Age (second)	20	20
Forwarding Delay (second)	15	15
Cost to Bridge	0	
Port ID	0X0000	
Topology Changed Times		0
Time Since Last Change		0:00:11

The following table describes the labels in this screen.

Table 25 Rapid Spanning Tree Protocol: Status

LABEL	DESCRIPTION
Configuration	Click Configuration to configure RSTP settings. Refer to Section 11.3 on page 100 .
Bridge	Root refers to the base of the spanning tree (the root bridge). Our Bridge is this switch. This switch may also be the root bridge.
Bridge ID	This is the unique identifier for this bridge, consisting of bridge priority plus MAC address. This ID is the same for Root and Our Bridge if the switch is the root switch.
Hello Time (second)	This is the time interval (in seconds) at which the root switch transmits a configuration message. The root bridge determines Hello Time , Max Age and Forwarding Delay
Max Age (second)	This is the maximum time (in seconds) a switch can wait without receiving a configuration message before attempting to reconfigure.
Forwarding Delay (second)	This is the time (in seconds) the root switch will wait before changing states (that is, listening to learning to forwarding).
Cost to Bridge	This is the path cost from the root port on this switch to the root switch.
Port ID	This is the priority and number of the port on the switch through which this switch must communicate with the root of the Spanning Tree.
Topology Changed Times	This is the number of times the spanning tree has been reconfigured.
Time Since Last Change	This is the time since the spanning tree was last reconfigured.

11.5 Configure Multiple Rapid Spanning Tree Protocol

To configure MRSTP, select **MRSTP** in the **Advanced Application, Spanning Tree Protocol** screen. See [Section 11.1 on page 97](#) for more information on MRSTP.

Figure 47 MRSTP: Configuration

Tree	Active	Bridge Priority	Hello Time	MAX Age	Forwarding Delay
1	<input type="checkbox"/>	32768	2 seconds	20 seconds	15
2	<input type="checkbox"/>	32768	2 seconds	20 seconds	15
3	<input type="checkbox"/>	32768	2 seconds	20 seconds	15
4	<input type="checkbox"/>	32768	2 seconds	20 seconds	15

Port	Active	Priority	Path Cost	Tree
*	<input type="checkbox"/>			1
1	<input type="checkbox"/>	128	4	1
2	<input type="checkbox"/>	128	4	1
3	<input type="checkbox"/>	128	4	1
4	<input type="checkbox"/>	128	4	1
5	<input type="checkbox"/>	128	4	1
6	<input type="checkbox"/>	128	4	1
7	<input type="checkbox"/>	128	4	1
8	<input type="checkbox"/>	128	4	1

Apply Cancel

The following table describes the labels in this screen.

Table 26 MRSTP: Configuration

LABEL	DESCRIPTION
Status	Click Status to display the MRSTP Status screen (see Figure 46 on page 103).
Tree	This is a read only index number of the STP trees.
Active	Select this check box to activate an STP tree. Clear this checkbox to disable an STP tree.
Bridge Priority	<p>Bridge priority is used in determining the root switch, root port and designated port. The switch with the highest priority (lowest numeric value) becomes the STP root switch. If all switches have the same priority, the switch with the lowest MAC address will then become the root switch. Select a value from the drop-down list box.</p> <p>The lower the numeric value you assign, the higher the priority for this bridge.</p> <p>Bridge Priority determines the root bridge, which in turn determines Hello Time, Max Age and Forwarding Delay.</p>
Hello Time	This is the time interval in seconds between BPDU (Bridge Protocol Data Units) configuration message generations by the root switch. The allowed range is 1 to 10 seconds.

Table 26 MRSTP: Configuration (continued)

LABEL	DESCRIPTION
Max Age	This is the maximum time (in seconds) a switch can wait without receiving a BPDU before attempting to reconfigure. All switch ports (except for designated ports) should receive BPDUs at regular intervals. Any port that ages out STP information (provided in the last BPDU) becomes the designated port for the attached LAN. If it is a root port, a new root port is selected from among the switch ports attached to the network. The allowed range is 6 to 40 seconds.
Forwarding Delay	This is the maximum time (in seconds) a switch will wait before changing states. This delay is required because every switch must receive information about topology changes before it starts to forward frames. In addition, each port needs time to listen for conflicting information that would make it return to a blocking state; otherwise, temporary data loops might result. The allowed range is 4 to 30 seconds. As a general rule: Note: $2 * (\text{Forward Delay} - 1) \geq \text{Max Age} \geq 2 * (\text{Hello Time} + 1)$
Port	This field displays the port number.
*	Settings in this row apply to all ports. Use this row only if you want to make some settings the same for all ports. Use this row first to set the common settings and then make adjustments on a port-by-port basis. Note: Changes in this row are copied to all the ports as soon as you make them.
Active	Select this check box to activate STP on this port.
Priority	Configure the priority for each port here. Priority decides which port should be disabled when more than one port forms a loop in a switch. Ports with a higher priority numeric value are disabled first. The allowed range is between 0 and 255.
Path Cost	Path cost is the cost of transmitting a frame on to a LAN through that port. It is assigned according to the speed of the bridge. The slower the media, the higher the cost - see Table 21 on page 97 for more information.
Tree	Select which STP tree configuration this port should participate in.
Apply	Click Apply to save your changes to the switch's run-time memory. The switch loses these changes if it is turned off or loses power, so use the Save link on the top navigation panel to save your changes to the non-volatile memory when you are done configuring.
Cancel	Click Cancel to reset the fields.

11.6 Multiple Rapid Spanning Tree Protocol Status

Click **Advanced Application, Spanning Tree Protocol** in the navigation panel to display the status screen as shown next. See [Section 11.1 on page 97](#) for more information on MRSTP.

Note: This screen is only available after you activate MRSTP on the switch.

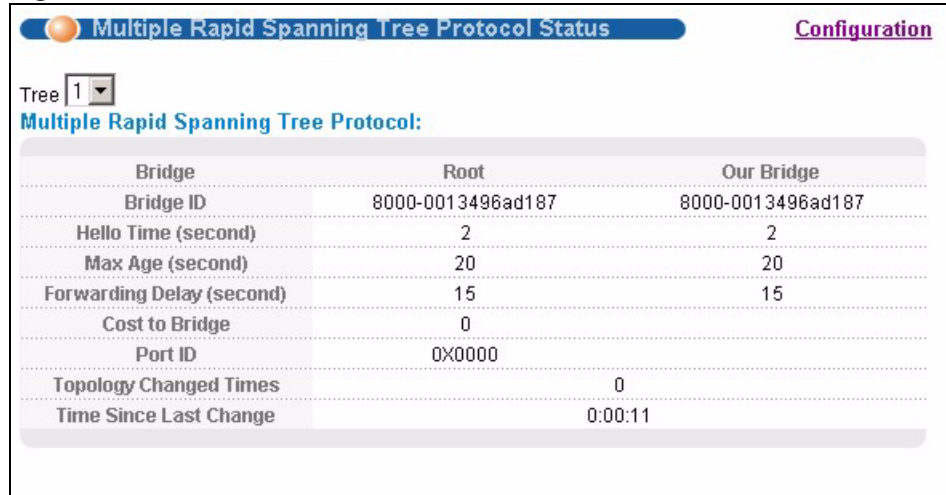
Figure 48 MRSTP: Status

Bridge	Root	Our Bridge
Bridge ID	8000-0013496ad187	8000-0013496ad187
Hello Time (second)	2	2
Max Age (second)	20	20
Forwarding Delay (second)	15	15
Cost to Bridge	0	
Port ID	0x0000	
Topology Changed Times		0
Time Since Last Change		0:00:11

The following table describes the labels in this screen.

Table 27 Spanning Tree Protocol: Status

LABEL	DESCRIPTION
Configuration	Click Configuration to configure MRSTP settings. Refer to Section 11.3 on page 100 .
Tree	Select which STP tree configuration you want to view.
Bridge	Root refers to the base of the spanning tree (the root bridge). Our Bridge is this switch. This switch may also be the root bridge.
Bridge ID	This is the unique identifier for this bridge, consisting of bridge priority plus MAC address. This ID is the same for Root and Our Bridge if the switch is the root switch.
Hello Time (second)	This is the time interval (in seconds) at which the root switch transmits a configuration message. The root bridge determines Hello Time , Max Age and Forwarding Delay .
Max Age (second)	This is the maximum time (in seconds) a switch can wait without receiving a configuration message before attempting to reconfigure.
Forwarding Delay (second)	This is the time (in seconds) the root switch will wait before changing states (that is, listening to learning to forwarding).
Cost to Bridge	This is the path cost from the root port on this switch to the root switch.
Port ID	This is the priority and number of the port on the switch through which this switch must communicate with the root of the Spanning Tree.
Topology Changed Times	This is the number of times the spanning tree has been reconfigured.
Time Since Last Change	This is the time since the spanning tree was last reconfigured.

CHAPTER 12

Bandwidth Control

This chapter shows you how you can cap the maximum bandwidth using the **Bandwidth Control** screen.

12.1 Bandwidth Control Overview

Bandwidth control means defining a maximum allowable bandwidth for incoming and/or outgoing traffic flows on a port.

12.1.1 CIR and PIR

The Committed Information Rate (CIR) is the guaranteed bandwidth for the incoming traffic flow on a port. The Peak Information Rate (PIR) is the maximum bandwidth allowed for the incoming traffic flow on a port when there is no network congestion.

The CIR and PIR should be set for all ports that use the same uplink bandwidth. If the CIR is reached, packets are sent at the rate up to the PIR. When network congestion occurs, packets through the ingress port exceeding the CIR will be marked for drop.

Note: The CIR should be less than the PIR.

The sum of CIRs cannot be greater than or equal to the uplink bandwidth.

12.2 Bandwidth Control Setup

Click **Advanced Application** and then **Bandwidth Control** in the navigation panel to bring up the screen as shown next.

Figure 49 Bandwidth Control

Port	Ingress Rate						Egress Rate
	Active	Commit Rate	Active	Peak Rate	Active		
*	<input type="checkbox"/>	<input type="text"/> Kbps	<input type="checkbox"/>	<input type="text"/> Kbps	<input type="checkbox"/>	<input type="text"/> Kbps	
1	<input type="checkbox"/>	1 Kbps	<input type="checkbox"/>	1000 Kbps	<input type="checkbox"/>	1000 Kbps	
2	<input type="checkbox"/>	1 Kbps	<input type="checkbox"/>	1000 Kbps	<input type="checkbox"/>	1000 Kbps	
3	<input type="checkbox"/>	1 Kbps	<input type="checkbox"/>	1000 Kbps	<input type="checkbox"/>	1000 Kbps	
4	<input type="checkbox"/>	1 Kbps	<input type="checkbox"/>	1000 Kbps	<input type="checkbox"/>	1000 Kbps	
5	<input type="checkbox"/>	1 Kbps	<input type="checkbox"/>	1000 Kbps	<input type="checkbox"/>	1000 Kbps	
6	<input type="checkbox"/>	1 Kbps	<input type="checkbox"/>	1000 Kbps	<input type="checkbox"/>	1000 Kbps	
7	<input type="checkbox"/>	1 Kbps	<input type="checkbox"/>	1000 Kbps	<input type="checkbox"/>	1000 Kbps	
8	<input type="checkbox"/>	1 Kbps	<input type="checkbox"/>	1000 Kbps	<input type="checkbox"/>	1000 Kbps	

Apply Cancel

The following table describes the related labels in this screen.

Table 28 Bandwidth Control

LABEL	DESCRIPTION
Active	Select this check box to enable bandwidth control on the switch.
Port	This field displays the port number.
*	Settings in this row apply to all ports. Use this row only if you want to make some settings the same for all ports. Use this row first to set the common settings and then make adjustments on a port-by-port basis. Note: Changes in this row are copied to all the ports as soon as you make them.
Ingress Rate	
Active	Select this check box to activate commit rate limits on this port.
Commit Rate	Specify the guaranteed bandwidth allowed in kilobits per second (Kbps) for the incoming traffic flow on a port. The commit rate should be less than the peak rate. The sum of commit rates cannot be greater than or equal to the uplink bandwidth.
Active	Select this check box to activate peak rate limits on this port.
Peak Rate	Specify the maximum bandwidth allowed in kilobits per second (Kbps) for the incoming traffic flow on a port.
Active	Select this check box to activate egress rate limits on this port.
Egress Rate	Specify the maximum bandwidth allowed in kilobits per second (Kbps) for the out-going traffic flow on a port.
Apply	Click Apply to save your changes to the switch's run-time memory. The switch loses these changes if it is turned off or loses power, so use the Save link on the top navigation panel to save your changes to the non-volatile memory when you are done configuring.
Cancel	Click Cancel to reset the fields.

CHAPTER 13

Broadcast Storm Control

This chapter introduces and shows you how to configure the broadcast storm control feature.

13.1 Broadcast Storm Control Setup

Broadcast storm control limits the number of broadcast, multicast and destination lookup failure (DLF) packets the switch receives per second on the ports. When the maximum number of allowable broadcast, multicast and/or DLF packets is reached per second, the subsequent packets are discarded. Enable this feature to reduce broadcast, multicast and/or DLF packets in your network. You can specify limits for each packet type on each port.

Click **Advanced Application, Broadcast Storm Control** in the navigation panel to display the screen as shown next.

Figure 50 Broadcast Storm Control

Port	Broadcast (pkt/s)	Multicast (pkt/s)	DLF (pkt/s)
*	<input type="checkbox"/> []	<input type="checkbox"/> []	<input type="checkbox"/> []
1	<input type="checkbox"/> [0]	<input type="checkbox"/> [0]	<input type="checkbox"/> [0]
2	<input type="checkbox"/> [0]	<input type="checkbox"/> [0]	<input type="checkbox"/> [0]
3	<input type="checkbox"/> [0]	<input type="checkbox"/> [0]	<input type="checkbox"/> [0]
4	<input type="checkbox"/> [0]	<input type="checkbox"/> [0]	<input type="checkbox"/> [0]
5	<input type="checkbox"/> [0]	<input type="checkbox"/> [0]	<input type="checkbox"/> [0]
6	<input type="checkbox"/> [0]	<input type="checkbox"/> [0]	<input type="checkbox"/> [0]
7	<input type="checkbox"/> [0]	<input type="checkbox"/> [0]	<input type="checkbox"/> [0]
8	<input type="checkbox"/> [0]	<input type="checkbox"/> [0]	<input type="checkbox"/> [0]

The following table describes the labels in this screen.

Table 29 Broadcast Storm Control

LABEL	DESCRIPTION
Active	Select this check box to enable traffic storm control on the switch. Clear this check box to disable this feature.
Port	This field displays a port number.
*	Settings in this row apply to all ports. Use this row only if you want to make some settings the same for all ports. Use this row first to set the common settings and then make adjustments on a port-by-port basis. Note: Changes in this row are copied to all the ports as soon as you make them.
Broadcast (pkt/s)	Select this option and specify how many broadcast packets the port receives per second.
Multicast (pkt/s)	Select this option and specify how many multicast packets the port receives per second.
DLF (pkt/s)	Select this option and specify how many destination lookup failure (DLF) packets the port receives per second.
Apply	Click Apply to save your changes to the switch's run-time memory. The switch loses these changes if it is turned off or loses power, so use the Save link on the top navigation panel to save your changes to the non-volatile memory when you are done configuring.
Cancel	Click Cancel to reset the fields.

CHAPTER 14

Mirroring

This chapter discusses port mirroring setup screens.

14.1 Port Mirroring Setup

Port mirroring allows you to copy a traffic flow to a monitor port (the port you copy the traffic to) in order that you can examine the traffic from the monitor port without interference.

Click **Advanced Application, Mirroring** in the navigation panel to display the **Mirroring** screen. Use this screen to select a monitor port and specify the traffic flow to be copied to the monitor port.

Figure 51 Mirroring

Port	Mirrored	Direction
*	<input type="checkbox"/>	Ingress ▾
1	<input type="checkbox"/>	Ingress ▾
2	<input type="checkbox"/>	Ingress ▾
3	<input type="checkbox"/>	Ingress ▾
4	<input type="checkbox"/>	Ingress ▾
5	<input type="checkbox"/>	Ingress ▾
6	<input type="checkbox"/>	Ingress ▾
7	<input type="checkbox"/>	Ingress ▾
8	<input type="checkbox"/>	Ingress ▾

The following table describes the labels in this screen.

Table 30 Mirroring

LABEL	DESCRIPTION
Active	Select this check box to activate port mirroring on the switch. Clear this check box to disable the feature.
Monitor Port	The monitor port is the port you copy the traffic to in order to examine it in more detail without interfering with the traffic flow on the original port(s). Enter the port number of the monitor port.
Port	This field displays the port number.
*	Settings in this row apply to all ports. Use this row only if you want to make some settings the same for all ports. Use this row first to set the common settings and then make adjustments on a port-by-port basis. Note: Changes in this row are copied to all the ports as soon as you make them.
Mirrored	Select this option to mirror the traffic on a port.
Direction	Specify the direction of the traffic to mirror by selecting from the drop-down list box. Choices are Egress (outgoing), Ingress (incoming) and Both .
Apply	Click Apply to save your changes to the switch's run-time memory. The switch loses these changes if it is turned off or loses power, so use the Save link on the top navigation panel to save your changes to the non-volatile memory when you are done configuring.
Cancel	Click Cancel to reset the fields.

CHAPTER 15

Link Aggregation

This chapter shows you how to logically aggregate physical links to form one logical, higher-bandwidth link.

15.1 Link Aggregation Overview

Link aggregation (trunking) is the grouping of physical ports into one logical higher-capacity link. You may want to trunk ports if for example, it is cheaper to use multiple lower-speed links than to under-utilize a high-speed, but more costly, single-port link.

However, the more ports you aggregate then the fewer available ports you have. A trunk group is one logical link containing multiple ports.

The beginning port of each trunk group must be physically connected to form a trunk group.

15.2 Dynamic Link Aggregation

The switch adheres to the IEEE 802.3ad standard for static and dynamic (LACP) port trunking.

The switch supports the link aggregation IEEE802.3ad standard. This standard describes the Link Aggregate Control Protocol (LACP), which is a protocol that dynamically creates and manages trunk groups.

When you enable LACP link aggregation on a port, the port can automatically negotiate with the ports at the remote end of a link to establish trunk groups. LACP also allows port redundancy, that is, if an operational port fails, then one of the “standby” ports become operational without user intervention. Please note that:

- You must connect all ports point-to-point to the same Ethernet switch and configure the ports for LACP trunking.
- LACP only works on full-duplex links.
- All ports in the same trunk group must have the same media type, speed, duplex mode and flow control settings.

Configure trunk groups or LACP before you connect the Ethernet switch to avoid causing network topology loops.

15.2.1 Link Aggregation ID

LACP aggregation ID consists of the following information¹:

Table 31 Link Aggregation ID: Local Switch

SYSTEM PRIORITY	MAC ADDRESS	KEY	PORT PRIORITY	PORT NUMBER
0000	00-00-00-00-00	0000	00	0000

Table 32 Link Aggregation ID: Peer Switch

SYSTEM PRIORITY	MAC ADDRESS	KEY	PORT PRIORITY	PORT NUMBER
0000	00-00-00-00-00	0000	00	0000

15.3 Link Aggregation Control Protocol Status

Click **Advanced Application**, **Link Aggregation** in the navigation panel. The **Link Aggregation Control Protocol Status** screen displays by default. See [Section 15.1 on page 113](#) for more information.

1. Port Priority and Port Number are 0 as it is the aggregator ID for the trunk group, not the individual port.

Figure 52 Link Aggregation Control Protocol Status

Link Aggregation Control Protocol Status		Configuration	
Index	Aggregator ID	Enabled Ports	Synchronized Ports
1	[(0000,00-00-00-00-00-00,0000,00,0000)] [(0000,00-00-00-00-00-00,0000,00,0000)]	-	-
2	[(0000,00-00-00-00-00-00,0000,00,0000)] [(0000,00-00-00-00-00-00,0000,00,0000)]	-	-
3	[(0000,00-00-00-00-00-00,0000,00,0000)] [(0000,00-00-00-00-00-00,0000,00,0000)]	-	-
4	[(0000,00-00-00-00-00-00,0000,00,0000)] [(0000,00-00-00-00-00-00,0000,00,0000)]	-	-
5	[(0000,00-00-00-00-00-00,0000,00,0000)] [(0000,00-00-00-00-00-00,0000,00,0000)]	-	-
6	[(0000,00-00-00-00-00-00,0000,00,0000)] [(0000,00-00-00-00-00-00,0000,00,0000)]	-	-

The following table describes the labels in this screen.

Table 33 Link Aggregation Control Protocol Status

LABEL	DESCRIPTION
Index	This field displays the trunk ID to identify a trunk group, that is, one logical link containing multiple ports.
Aggregator ID	Link Aggregator ID consists of the following: system priority, MAC address, key, port priority and port number. Refer to Section 15.2.1 on page 114 for more information on this field.
Enabled Port	These are the ports you have configured in the Link Aggregation screen to be in the trunk group.
Synchronized Ports	These are the ports that are currently transmitting data as one logical link in this trunk group.

15.4 Link Aggregation Setup

Click **Configuration** in the **Link Aggregation Control Protocol Status** screen to display the screen shown next. See [Section 15.1 on page 113](#) for more information on link aggregation.

Figure 53 Link Aggregation Control Protocol: Configuration

Link Aggregation Status

Link Aggregation Control Protocol

Active

System Priority

Group ID	Active	Dynamic(LACP)
T1	<input type="checkbox"/>	<input type="checkbox"/>
T2	<input type="checkbox"/>	<input type="checkbox"/>
T3	<input type="checkbox"/>	<input type="checkbox"/>
T4	<input type="checkbox"/>	<input type="checkbox"/>
T5	<input type="checkbox"/>	<input type="checkbox"/>
T6	<input type="checkbox"/>	<input type="checkbox"/>

Port	Group	LACP Timeout
*	-	30 seconds
1	None	30 seconds
2	None	30 seconds
3	None	30 seconds
4	None	30 seconds
5	None	30 seconds
6	None	30 seconds
7	None	30 seconds
8	None	30 seconds

Apply Cancel

The following table describes the labels in this screen.

Table 34 Link Aggregation Control Protocol: Configuration

LABEL	DESCRIPTION
Link Aggregation Control Protocol	
Active	Select this checkbox to enable Link Aggregation Control Protocol (LACP).
System Priority	LACP system priority is a number between 1 and 65,535. The switch with the lowest system priority (and lowest port number if system priority is the same) becomes the LACP "server". The LACP "server" controls the operation of LACP setup. Enter a number to set the priority of an active port using Link Aggregate Control Protocol (LACP). The smaller the number, the higher the priority level.
Group ID	The field identifies the link aggregation group, that is, one logical link containing multiple ports.
Active	Select this option to activate a trunk group.
Dynamic (LACP)	Select this check box to enable LACP for a trunk.

Table 34 Link Aggregation Control Protocol: Configuration (continued)

LABEL	DESCRIPTION
Port	This field displays the port number.
*	<p>Settings in this row apply to all ports. Use this row only if you want to make some settings the same for all ports. Use this row first to set the common settings and then make adjustments on a port-by-port basis.</p> <p>Note: Changes in this row are copied to all the ports as soon as you make them.</p>
Group	Select the trunk group to which a port belongs.
LACP Timeout	<p>Timeout is the time interval between the individual port exchanges of LACP packets in order to check that the peer port in the trunk group is still up. If a port does not respond after three tries, then it is deemed to be “down” and is removed from the trunk. Set a short timeout (one second) for busy trunked links to ensure that disabled ports are removed from the trunk group as soon as possible.</p> <p>Select either 1 second or 30 seconds.</p>
Apply	Click Apply to save your changes to the switch's run-time memory. The switch loses these changes if it is turned off or loses power, so use the Save link on the top navigation panel to save your changes to the non-volatile memory when you are done configuring.
Cancel	Click Cancel to reset the fields.

CHAPTER 16

Port Authentication

This chapter describes the 802.1x authentication method and RADIUS server connection setup. See [Section 44.8 on page 308](#) for information on how to use the commands to configure additional Radius server settings as well as multiple Radius server configuration.

16.1 Port Authentication Overview

IEEE 802.1x is an extended authentication protocol² that allows support of RADIUS (Remote Authentication Dial In User Service, RFC 2138, 2139) for centralized user profile and accounting management on a network RADIUS server.

16.1.1 RADIUS

RADIUS (Remote Authentication Dial-In User Service) authentication is a popular protocol used to authenticate users by means of an external server instead of (or in addition to) an internal device user database that is limited to the memory capacity of the device. In essence, RADIUS authentication allows you to validate an unlimited number of users from a central location.

Figure 54 RADIUS Server

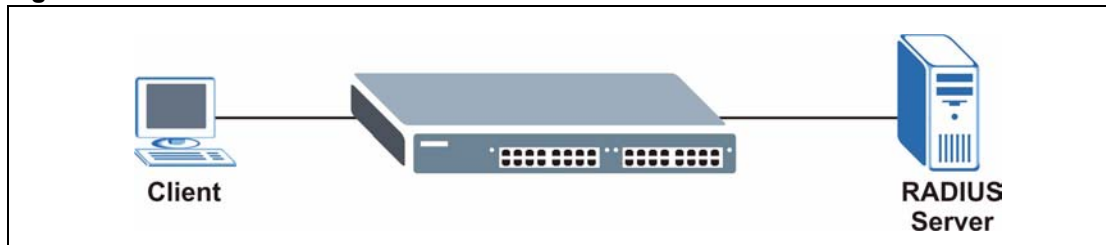

16.1.1.1 Vendor Specific Attribute

A Vendor Specific Attribute (VSA) is an attribute-value pair that is sent between a RADIUS server and the switch. Configure VSAs on the RADIUS server to set the switch to perform the following actions on an authenticated user:

- Limit bandwidth on incoming or outgoing traffic
- Assign account privilege levels

2. At the time of writing, only Windows XP of the Microsoft operating systems supports it. See the Microsoft web site for information on other Windows operating system support. For other operating systems, see its documentation. If your operating system does not support 802.1x, then you may need to install 802.1x client software.

Note: Refer to the documentation that comes with your RADIUS server on how to configure a VSA.

The following table describes the VSAs supported on the switch.

Table 35 Supported VSA

FUNCTION	ATTRIBUTE
Ingress Bandwidth Assignment	Vendor-Id = 890 (ZyXEL) Vendor-Type = 1 Vendor-data = ingress rate (decimal)
Egress Bandwidth Assignment	Vendor-Id = 890 (ZyXEL) Vendor-Type = 2 Vendor-data = egress rate (decimal)
Privilege Assignment	Vendor-ID = 890 (ZyXEL) Vendor-Type = 3 Vendor-Data = " shell:priv-lvl=N " or Vendor-ID = 9 (CISCO) Vendor-Type = 1 (CISCO-AVPAIR) Vendor-Data = " shell:priv-lvl=N " where N is a privilege level (from 0 to 14). Note: If you set the privilege level of a login account differently on the RADIUS server(s) and the switch, the user is assigned a privilege level from the database (RADIUS or local) the switch uses first for user authentication.

16.1.1.2 Tunnel Protocol Attribute

You can configure tunnel protocol attributes on the RADIUS server to assign a port on the switch to a VLAN (fixed, untagged). This will also set the port's VID. Refer to RFC 3580 for more information.

Table 36 Supported Tunnel Protocol Attribute

FUNCTION	ATTRIBUTE
VLAN Assignment	Tunnel-Type = VLAN (13) Tunnel-Medium-Type = 802 (6) Tunnel-Private-Group-ID = VLAN ID Note: You must also create a VLAN with the specified VID on the switch.

16.2 Port Authentication Configuration

To enable port authentication, first activate IEEE802.1x security (both on the switch and the port(s)) then configure the RADIUS server settings.

Click **Advanced Application, Port Authentication** in the navigation panel to display the screen as shown.

Figure 55 Port Authentication



16.2.1 Configuring RADIUS Server Settings

Use this screen to configure your RADIUS server settings. See [Section 16.1.1 on page 119](#) for more information on RADIUS servers. From the **Port Authentication** screen, click **RADIUS** to display the configuration screen as shown.

Figure 56 Port Authentication: RADIUS

The following table describes the labels in this screen.

Table 37 Port Authentication: RADIUS

LABEL	DESCRIPTION
Authentication Server	
IP Address	Enter the IP address of the external RADIUS server in dotted decimal notation.
UDP Port	The default port of the RADIUS server for authentication is 1812 . You need not change this value unless your network administrator instructs you to do so.
Shared Secret	Specify a password (up to 32 alphanumeric characters) as the key to be shared between the external RADIUS server and the switch. This key is not sent over the network. This key must be the same on the external RADIUS server and the switch.
Apply	Click Apply to save your changes to the switch's run-time memory. The switch loses these changes if it is turned off or loses power, so use the Save link on the top navigation panel to save your changes to the non-volatile memory when you are done configuring.
Cancel	Click Cancel to reset the fields.

16.2.2 Activate IEEE 802.1x Security

Use this screen to activate IEEE 802.1x security. From the **Port Authentication** screen, display the configuration screen as shown.

Figure 57 Port Authentication: 802.1x

Port	Active	Reauthentication	Reauthentication Timer
*	<input type="checkbox"/>	On	seconds
1	<input type="checkbox"/>	On	3600 seconds
2	<input type="checkbox"/>	On	3600 seconds
3	<input type="checkbox"/>	On	3600 seconds
4	<input type="checkbox"/>	On	3600 seconds
5	<input type="checkbox"/>	On	3600 seconds
6	<input type="checkbox"/>	On	3600 seconds
7	<input type="checkbox"/>	On	3600 seconds
8	<input type="checkbox"/>	On	3600 seconds

The following table describes the labels in this screen.

Table 38 Port Authentication: 802.1x

LABEL	DESCRIPTION
Active	Select this check box to permit 802.1x authentication on the switch. Note: You must first enable 802.1x authentication on the switch before configuring it on each port.
Port	This field displays a port number.
*	Settings in this row apply to all ports. Use this row only if you want to make some settings the same for all ports. Use this row first to set the common settings and then make adjustments on a port-by-port basis. Note: Changes in this row are copied to all the ports as soon as you make them.
Active	Select this checkbox to permit 802.1x authentication on this port. You must first allow 802.1x authentication on the switch before configuring it on each port.
Reauthentication	Specify if a subscriber has to periodically re-enter his or her username and password to stay connected to the port.

Table 38 Port Authentication: 802.1x (continued)

LABEL	DESCRIPTION
Reauthentication Timer	Specify how often a client has to re-enter his or her username and password to stay connected to the port.
Apply	Click Apply to save your changes to the switch's run-time memory. The switch loses these changes if it is turned off or loses power, so use the Save link on the top navigation panel to save your changes to the non-volatile memory when you are done configuring.
Cancel	Click Cancel to reset the fields.

CHAPTER 17

Port Security

This chapter shows you how to set up port security.

17.1 About Port Security

Port security allows only packets with dynamically learned MAC addresses and/or configured static MAC addresses to pass through a port on the switch. The switch can learn up to 16K MAC addresses in total with no limit on individual ports other than the sum cannot exceed 16K.

For maximum port security, enable this feature, disable MAC address learning and configure static MAC address(es) for a port. It is not recommended you disable port security together with MAC address learning as this will result in many broadcasts. By default, MAC address learning is still enabled even though the port security is not activated.

17.2 Port Security Setup

Click **Advanced Application, Port Security** in the navigation panel to display the screen as shown.

Figure 58 Port Security

Port	Active	Address Learning	Limited Number of Learned MAC Address
*	<input type="checkbox"/>	<input checked="" type="checkbox"/>	<input type="text"/>
1	<input type="checkbox"/>	<input checked="" type="checkbox"/>	<input type="text" value="0"/>
2	<input type="checkbox"/>	<input checked="" type="checkbox"/>	<input type="text" value="0"/>
3	<input type="checkbox"/>	<input checked="" type="checkbox"/>	<input type="text" value="0"/>
4	<input type="checkbox"/>	<input checked="" type="checkbox"/>	<input type="text" value="0"/>
5	<input type="checkbox"/>	<input checked="" type="checkbox"/>	<input type="text" value="0"/>
6	<input type="checkbox"/>	<input checked="" type="checkbox"/>	<input type="text" value="0"/>
7	<input type="checkbox"/>	<input checked="" type="checkbox"/>	<input type="text" value="0"/>
8	<input type="checkbox"/>	<input checked="" type="checkbox"/>	<input type="text" value="0"/>

The following table describes the labels in this screen.

Table 39 Port Security

LABEL	DESCRIPTION
Active	Select this option to enable port security on the switch.
Port	This field displays a port number.
*	Settings in this row apply to all ports. Use this row only if you want to make some settings the same for all ports. Use this row first to set the common settings and then make adjustments on a port-by-port basis. Note: Changes in this row are copied to all the ports as soon as you make them.
Active	Select this check box to enable the port security feature on this port. The switch forwards packets whose MAC address(es) is in the MAC address table on this port. Packets with no matching MAC address(es) are dropped. Clear this check box to disable the port security feature. The switch forwards all packets on this port.
Address Learning	MAC address learning reduces outgoing broadcast traffic. For MAC address learning to occur on a port, the port itself must be active with address learning enabled.
Limited Number of Learned MAC Address	Use this field to limit the number of (dynamic) MAC addresses that may be learned on a port. For example, if you set this field to "5" on port 2, then only the devices with these five learned MAC addresses may access port 2 at any one time. A sixth device would have to wait until one of the five learned MAC addresses aged out. MAC address aging out time can be set in the Switch Setup screen. The valid range is from "0" to "16384". "0" means this feature is disabled.

Table 39 Port Security (continued)

LABEL	DESCRIPTION
Apply	Click Apply to save your changes to the switch's run-time memory. The switch loses these changes if it is turned off or loses power, so use the Save link on the top navigation panel to save your changes to the non-volatile memory when you are done configuring.
Cancel	Click Cancel to reset the fields.

CHAPTER 18

Classifier

This chapter introduces and shows you how to configure the packet classifier on the switch.

18.1 About the Classifier and QoS

Quality of Service (QoS) refers to both a network's ability to deliver data with minimum delay, and the networking methods used to control the use of bandwidth. Without QoS, all traffic data is equally likely to be dropped when the network is congested. This can cause a reduction in network performance and make the network inadequate for time-critical application such as video-on-demand.

A classifier groups traffic into data flows according to specific criteria such as the source address, destination address, source port number, destination port number or incoming port number. For example, you can configure a classifier to select traffic from the same protocol port (such as Telnet) to form a flow.

Configure QoS on the switch to group and prioritize application traffic and fine-tune network performance. Setting up QoS involves two separate steps:

- 1 Configure classifiers to sort traffic into different flows.
- 2 Configure policy rules to define actions to be performed for a classified traffic flow (refer to [Chapter 19 on page 135](#) to configure policy rules).

18.2 Configuring the Classifier

Use the **Classifier** screen to define the classifiers. After you define the classifier, you can specify actions (or policy) to act upon the traffic that matches the rules. To configure policy rules, refer to [Chapter 19 on page 135](#).

Click **Advanced Application** and **Classifier** in the navigation panel to display the configuration screen as shown.

Figure 59 Classifier

The following table describes the labels in this screen.

Table 40 Classifier

LABEL	DESCRIPTION
Active	Select this option to enable this rule.
Name	Enter a descriptive name for this rule for identifying purposes.
Packet Format	Specify the format of the packet. Choices are All , 802.3 tagged , 802.3 untagged , Ethernet II tagged and Ethernet II untagged . A value of 802.3 indicates that the packets are formatted according to the IEEE 802.3 standards. A value of Ethernet II indicates that the packets are formatted according to RFC 894, Ethernet II encapsulation.
Layer 2	Specify the fields below to configure a layer 2 classifier.
VLAN	Select Any to classify traffic from any VLAN or select the second option and specify the source VLAN ID in the field provided.

Table 40 Classifier (continued)

LABEL	DESCRIPTION
Priority	Select Any to classify traffic from any priority level or select the second option and specify a priority level in the field provided.
Ethernet Type	Select an Ethernet type or select Other and enter the Ethernet type number in hexadecimal value. Refer to Table 42 on page 132 for information.
Source	
MAC Address	Select Any to apply the rule to all MAC addresses. To specify a source, select the second choice and type a MAC address in valid MAC address format (six hexadecimal character pairs).
Port	Type the port number to which the rule should be applied. You may choose one port only or all ports (Any).
Destination	
MAC Address	Select Any to apply the rule to all MAC addresses. To specify a destination, select the second choice and type a MAC address in valid MAC address format (six hexadecimal character pairs).
Layer 3 Specify the fields below to configure a layer 3 classifier.	
DSCP	Select Any to classify traffic from any DSCP or select the second option and specify a DSCP (DiffServ Code Point) number between 0 and 63 in the field provided.
IP Protocol	Select an IP protocol type or select Other and enter the protocol number in decimal value. Refer to Table 43 on page 133 for more information. You may select Establish Only for TCP protocol type. This means that the switch will pick out the packets that are sent to establish TCP connections.
Source	
IP Address/ Address Prefix	Enter a source IP address in dotted decimal notation. Specify the address prefix by entering the number of ones in the subnet mask.
Socket Number	Note: You must select either UDP or TCP in the IP Protocol field before you configure the socket numbers. Select Any to apply the rule to all TCP/UDP protocol port numbers or select the second option and enter a TCP/UDP protocol port number.
Destination	
IP Address/ Address Prefix	Enter a destination IP address in dotted decimal notation. Specify the address prefix by entering the number of ones in the subnet mask.
Socket Number	Note: You must select either UDP or TCP in the IP Protocol field before you configure the socket numbers. Select Any to apply the rule to all TCP/UDP protocol port numbers or select the second option and enter a TCP/UDP protocol port number.
Add	Click Add to insert the entry in the summary table below and save your changes to the switch's run-time memory. The switch loses these changes if it is turned off or loses power, so use the Save link on the top navigation panel to save your changes to the non-volatile memory when you are done configuring.

Table 40 Classifier (continued)

LABEL	DESCRIPTION
Cancel	Click Cancel to reset the fields back to your previous configuration.
Clear	Click Clear to set the above fields back to the factory defaults.

18.3 Viewing and Editing Classifier Configuration

To view a summary of the classifier configuration, scroll down to the summary table at the bottom of the **Classifier** screen. To change the settings of a rule, click a number in the **Index** field.

Note: When two rules conflict with each other, a higher layer rule has priority over lower layer rule.

Figure 60 Classifier: Summary Table

Index	Active	Name	Rule	Delete
1	Yes	Example	EtherType = IP; SrcMac = 00:50:ba:ad:4f:81; SrcPort = port 2;	<input type="checkbox"/>

Delete Cancel

The following table describes the labels in this screen.

Table 41 Classifier: Summary Table

LABEL	DESCRIPTION
Index	This field displays the index number of the rule. Click an index number to edit the rule.
Active	This field displays Yes when the rule is activated and No when it is deactivated.
Name	This field displays the descriptive name for this rule. This is for identification purpose only.
Rule	This field displays a summary of the classifier rule's settings.
Delete	Click Delete to remove the selected entry from the summary table.
Cancel	Click Cancel to clear the Delete check boxes.

The following table shows some other common Ethernet types and the corresponding protocol number.

Table 42 Common Ethernet Types and Protocol Number

ETHERNET TYPE	PROTOCOL NUMBER
IP ETHII	0800
X.75 Internet	0801
NBS Internet	0802
ECMA Internet	0803
Chaosnet	0804

Table 42 Common Ethernet Types and Protocol Number

ETHERNET TYPE	PROTOCOL NUMBER
X.25 Level 3	0805
XNS Compat	0807
Banyan Systems	0BAD
BBN Simnet	5208
IBM SNA	80D5
AppleTalk AARP	80F3

Some of the most common IP ports are:

Table 43 Common IP Ports

PORT NUMBER	PORT NAME
21	FTP
23	Telnet
25	SMTP
53	DNS
80	HTTP
110	POP3

18.4 Classifier Example

The following screen shows an example where you configure a classifier that identifies all traffic from MAC address 00:50:ba:ad:4f:81 on port 2.

After you have configured a classifier, you can configure a policy (in the **Policy** screen) to define action(s) on the classified traffic flow.

Figure 61 Classifier: Example

● **Classifier**

Active	<input checked="" type="checkbox"/>		
Name	<input type="text" value="Example"/>		
Packet Format	<input type="text" value="All"/>		
Layer 2	VLAN	<input checked="" type="radio"/> Any	<input type="text"/>
	Priority	<input type="radio"/> Any	<input type="text" value="0"/>
	Ethernet Type	<input checked="" type="radio"/> All	<input type="text" value="All"/>
		<input type="radio"/> Others	<input type="text"/> (Hex)
	Source	<input checked="" type="radio"/> Any	<input type="text" value="MAC 00 : 50 : ba : ad : 4f : 81"/>
		<input type="radio"/> Any	<input type="text" value="2"/>
Destination	<input checked="" type="radio"/> Any	<input type="text" value="MAC : : : : :"/>	
Layer 3	DSCP	<input checked="" type="radio"/> Any	<input type="text"/>
	IP Protocol	<input checked="" type="radio"/> All	<input type="checkbox"/> Establish Only
		<input type="radio"/> Others	<input type="text"/> (Dec)
	Source	IP Address / Address Prefix	<input type="text" value="0.0.0.0"/> / <input type="text"/>
		Socket Number	<input checked="" type="radio"/> Any
		<input type="radio"/>	<input type="text"/>
Destination	IP Address / Address Prefix	<input type="text" value="0.0.0.0"/> / <input type="text"/>	
	Socket Number	<input checked="" type="radio"/> Any	
	<input type="radio"/>	<input type="text"/>	

CHAPTER 19

Policy Rule

This chapter shows you how to configure policy rules.

19.1 Policy Rules Overview

A classifier distinguishes traffic into flows based on the configured criteria (refer to [Chapter 18 on page 129](#) for more information). A policy rule ensures that a traffic flow gets the requested treatment in the network.

19.1.1 DiffServ

DiffServ (Differentiated Services) is a class of service (CoS) model that marks packets so that they receive specific per-hop treatment at DiffServ-compliant network devices along the route based on the application types and traffic flow. Packets are marked with DiffServ Code Points (DSCPs) indicating the level of service desired. This allows the intermediary DiffServ-compliant network devices to handle the packets differently depending on the code points without the need to negotiate paths or remember state information for every flow. In addition, applications do not have to request a particular service or give advanced notice of where the traffic is going.

19.1.2 DSCP and Per-Hop Behavior

DiffServ defines a new DS (Differentiated Services) field to replace the Type of Service (TOS) field in the IP header. The DS field contains a 2-bit unused field and a 6-bit DSCP field which can define up to 64 service levels. The following figure illustrates the DS field.

DSCP is backward compatible with the three precedence bits in the ToS octet so that non-DiffServ compliant, ToS-enabled network device will not conflict with the DSCP mapping.

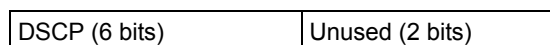

The DSCP value determines the forwarding behavior, the PHB (Per-Hop Behavior), that each packet gets across the DiffServ network. Based on the marking rule, different kinds of traffic can be marked for different kinds of forwarding. Resources can then be allocated according to the DSCP values and the configured policies.

19.2 Configuring Policy Rules

You must first configure a classifier in the **Classifier** screen. Refer to [Section 18.2 on page 129](#) for more information.

Click **Advanced Applications** and then **Policy Rule** in the navigation panel to display the screen as shown.

Figure 62 Policy

The screenshot shows the 'Policy' configuration interface. It includes an 'Active' checkbox, a 'Name' text field, and a 'Classifier(s)' list box. The 'Parameters' section is split into 'General' and 'Metering' tabs. The 'General' tab contains fields for 'VLAN ID', 'Egress Port', 'Outgoing packet format for Egress port' (with 'Tag' selected), 'Priority', 'DSCP', and 'TOS'. The 'Metering' tab contains 'Bandwidth' (Kbps) and 'Out-of-Profile DSCP'. The 'Action' section includes 'Forwarding' (No change selected), 'Priority' (No change selected), 'Diffserv' (No change selected), 'Outgoing' (Send the packet to the mirror port, Send the packet to the egress port, Send the matching frames to the egress port, Set the packet's VLAN ID), 'Metering' (Enable), and 'Out-of-profile action' (Drop the packet, Change the DSCP value, Set Out-Drop Precedence, Do not drop the matching frame previously marked for dropping).

The following table describes the labels in this screen.

Table 44 Policy

LABEL	DESCRIPTION
Active	Select this option to enable the policy.
Name	Enter a descriptive name for identification purposes.
Classifier(s)	This field displays the active classifier(s) you configure in the Classifier screen. Select the classifier(s) to which this policy rule applies. To select more than one classifier, press [SHIFT] and select the choices at the same time.

Table 44 Policy (continued)

LABEL	DESCRIPTION
Parameters Set the fields below for this policy. You only have to set the field(s) that is related to the action(s) you configure in the Action field.	
General	
VLAN ID	Specify a VLAN ID number.
Egress Port	Type the number of an outgoing port.
Outgoing packet format for Egress port	Select Tag to add the specified VID to packets on the specified outgoing port. Otherwise, select Untag .
Priority	Specify a priority level.
DSCP	Specify a DSCP (DiffServ Code Point) number between 0 and 63.
TOS	Specify the type of service (TOS) priority level.
Metering	
You can configure the desired bandwidth available to a traffic flow. Traffic that exceeds the maximum bandwidth allocated (in cases where the network is congested) is called out-of-profile traffic.	
Bandwidth	Specify the bandwidth in kilobit per second (Kbps). Enter a number between 1 and 1000000.
Out-of-Profile DSCP	Specify a new DSCP number (between 0 and 63) if you want to replace or remark the DSCP number for out-of-profile traffic.
Action	
Specify the action(s) the switch takes on the associated classified traffic flow.	
Forwarding	Select No change to forward the packets. Select Discard the packet to drop the packets. Select Do not drop the matching frame previously marked for dropping to retain the frames that were marked to be dropped before.
Priority	Select No change to keep the priority setting of the frames. Select Set the packet's 802.1 priority to replace the packet's 802.1 priority field with the value you set in the Priority field. Select Send the packet to priority queue to put the packets in the designated queue. Select Replace the 802.1 priority field with the IP TOS value to replace the packet's 802.1 priority field with the value you set in the TOS field.
Diffserv	Select No change to keep the TOS and/or DSCP fields in the packets. Select Set the packet's TOS field to set the TOS field with the value you configure in the TOS field. Select Replace the IP TOS with the 802.1 priority value to replace the TOS field with the value you configure in the Priority field. Select Set the Diffserv Codepoint field in the frame to set the DSCP field with the value you configure in the DSCP field.

Table 44 Policy (continued)

LABEL	DESCRIPTION
Outgoing	Select Send the packet to the mirror port to send the packet to the mirror port. Select Send the packet to the egress port to send the packet to the egress port. Select Send the matching frames (broadcast or DLF, multicast, marked for dropping or to be sent to the CPU) to the egress port to send the broadcast, multicast, DLF, marked-to-drop or CPU frames to the egress port. Select Set the packet's VLAN ID to set the VLAN ID of the packet with the value you configure in the VLAN ID field.
Metering	Select Enable to activate bandwidth limitation on the traffic flow(s) then set the actions to be taken on out-of-profile packets.
Out-of-profile action	Select the action(s) to be performed for out-of-profile traffic. Select Drop the packet to discard the out-of-profile traffic. Select Change the DSCP value to replace the DSCP field with the value specified in the Out of profile DSCP field. Select Set Out-Drop Precedence to mark out-of-profile traffic and drop it when network is congested. Select Do not drop the matching frame previously marked for dropping to queue the frames that are marked to be dropped.
Add	Click Add to inset the entry to the summary table below and save your changes to the switch's run-time memory. The switch loses these changes if it is turned off or loses power, so use the Save link on the top navigation panel to save your changes to the non-volatile memory when you are done configuring.
Cancel	Click Cancel to reset the fields back to your previous configuration.
Clear	Click Clear to set the above fields back to the factory defaults.

19.3 Viewing and Editing Policy Configuration

To view a summary of the classifier configuration, scroll down to the summary table at the bottom of the **Policy** screen. To change the settings of a rule, click a number in the **Index** field.

Figure 63 Policy: Summary Table

Index	Active	Name	Classifier(s)	Delete
1	Yes	Test	Example;	<input type="checkbox"/>

Delete Cancel

The following table describes the labels in this screen.

Table 45 Policy: Summary Table

LABEL	DESCRIPTION
Index	This field displays the policy index number. Click an index number to edit the policy.
Active	This field displays Yes when policy is activated and No when is it deactivated.
Name	This field displays the name you have assigned to this policy.
Classifier(s)	This field displays the name(s) of the classifier to which this policy applies.

Table 45 Policy: Summary Table (continued)

LABEL	DESCRIPTION
Delete	Click Delete to remove the selected entry from the summary table.
Cancel	Click Cancel to clear the Delete check boxes.

19.4 Policy Example

The figure below shows an example **Policy** screen where you configure a policy to limit bandwidth and discard out-of-profile traffic on a traffic flow classified using the **Example** classifier (refer to [Section 18.4 on page 133](#)).

Figure 64 Policy Example

Policy			
Active	<input checked="" type="checkbox"/>		
Name	Test		
Classifier(s)	Example		
Parameters	VLAN ID	<input type="text"/>	
	Egress Port	<input type="text" value="1"/>	
	Outgoing packet format for Egress port	<input checked="" type="radio"/> Tag <input type="radio"/> Untag	
	Priority	<input type="text" value="0"/>	
	DSCP	<input type="text"/>	
	TOS	<input type="text" value="0"/>	
Action	General		
	Bandwidth		<input type="text" value="1000"/> Kbps
	Out-of-Profile DSCP		<input type="text" value="63"/>
	Forwarding		
	<input checked="" type="radio"/> No change		
	<input type="radio"/> Discard the packet		
	<input type="radio"/> Do not drop the matching frame previously marked for dropping		
	Priority		
	<input checked="" type="radio"/> No change		
	<input type="radio"/> Set the packet's 802.1 priority		
	<input type="radio"/> Send the packet to priority queue		
	<input type="radio"/> Replace the 802.1 priority field with the IP TOS value		
	Diffserv		
	<input checked="" type="radio"/> No change		
<input type="radio"/> Set the packet's TOS field			
<input type="radio"/> Replace the IP TOS field with the 802.1 priority value			
<input type="radio"/> Set the Diffserv Codepoint field in the frame			
Outgoing			
<input type="checkbox"/> Send the packet to the mirror port			
<input type="checkbox"/> Send the packet to the egress port			
<input type="checkbox"/> Send the matching frames(broadcast or DLF, multicast, marked for dropping or to be sent to the CPU) to the egress port			
<input type="checkbox"/> Set the packet's VLAN ID			
Metering			
<input type="checkbox"/> Enable			
Out-of-profile action	<input checked="" type="checkbox"/> Drop the packet		
	<input type="checkbox"/> Change the DSCP value		
	<input type="checkbox"/> Set Out-Drop Precedence		
	<input type="checkbox"/> Do not drop the matching frame previously marked for dropping		
<input type="button" value="Add"/> <input type="button" value="Cancel"/> <input type="button" value="Clear"/>			

CHAPTER 20

Queuing Method

This chapter introduces the queuing methods supported.

20.1 Queuing Method Overview

Queuing is used to help solve performance degradation when there is network congestion. Use the **Queuing Method** screen to configure queuing algorithms for outgoing traffic. See also **Priority Queue Assignment in Switch Setup** and **802.1p Priority in Port Setup** for related information.

Queuing algorithms allow switches to maintain separate queues for packets from each individual source or flow and prevent a source from monopolizing the bandwidth.

20.1.1 Strictly Priority Queuing

Strictly Priority Queuing (SPQ) services queues based on priority only. As traffic comes into the switch, traffic on the highest priority queue, Q7 is transmitted first. When that queue empties, traffic on the next highest-priority queue, Q6 is transmitted until Q6 empties, and then traffic is transmitted on Q5 and so on. If higher priority queues never empty, then traffic on lower priority queues never gets sent. SP does not automatically adapt to changing network requirements.

20.1.2 Weighted Round Robin Scheduling (WRR)

Round Robin Scheduling services queues on a rotating basis and is activated only when a port has more traffic than it can handle. A queue is given an amount of bandwidth irrespective of the incoming traffic on that port. This queue then moves to the back of the list. The next queue is given an equal amount of bandwidth, and then moves to the end of the list; and so on, depending on the number of queues being used. This works in a looping fashion until a queue is empty.

Weighted Round Robin Scheduling (WRR) uses the same algorithm as round robin scheduling, but services queues based on their priority and queue weight (the number you configure in the queue **Weight** field) rather than a fixed amount of bandwidth. WRR is activated only when a port has more traffic than it can handle. Queues with larger weights get more service than queues with smaller weights. This queuing mechanism is highly efficient in that it divides any available bandwidth across the different traffic queues and returns to queues that have not yet emptied.

20.2 Configuring Queuing

Click **Advanced Application, Queuing Method** in the navigation panel.

Figure 65 Queuing Method

Port	Method	Weight							
		Q0	Q1	Q2	Q3	Q4	Q5	Q6	Q7
1	<input checked="" type="radio"/> SPQ <input type="radio"/> WRR	1	2	3	4	5	6	7	8
2	<input checked="" type="radio"/> SPQ <input type="radio"/> WRR	1	2	3	4	5	6	7	8
3	<input checked="" type="radio"/> SPQ <input type="radio"/> WRR	1	2	3	4	5	6	7	8
4	<input checked="" type="radio"/> SPQ <input type="radio"/> WRR	1	2	3	4	5	6	7	8
5	<input checked="" type="radio"/> SPQ <input type="radio"/> WRR	1	2	3	4	5	6	7	8
6	<input checked="" type="radio"/> SPQ <input type="radio"/> WRR	1	2	3	4	5	6	7	8
7	<input checked="" type="radio"/> SPQ <input type="radio"/> WRR	1	2	3	4	5	6	7	8
8	<input checked="" type="radio"/> SPQ <input type="radio"/> WRR	1	2	3	4	5	6	7	8
9	<input checked="" type="radio"/> SPQ <input type="radio"/> WRR	1	2	3	4	5	6	7	8
10	<input checked="" type="radio"/> SPQ <input type="radio"/> WRR	1	2	3	4	5	6	7	8
11	<input checked="" type="radio"/> SPQ <input type="radio"/> WRR	1	2	3	4	5	6	7	8
12	<input checked="" type="radio"/> SPQ <input type="radio"/> WRR	1	2	3	4	5	6	7	8

Apply Cancel

The following table describes the labels in this screen.

Table 46 Queuing Method

LABEL	DESCRIPTION
Port	This label shows the port you are configuring.
Method	Select SPQ (Strict Priority Queuing) or WRR (Weighted Round Robin). Strict Priority Queuing (SPQ) services queues based on priority only. When the highest priority queue empties, traffic on the next highest-priority queue begins. Q3 has the highest priority and Q0 the lowest. Weighted Round Robin Scheduling (WRR) services queues on a rotating basis based on their queue weight (the number you configure in the queue Weight field). Queues with larger weights get more service than queues with smaller weights.
Q0~Q7 Weight %	When you select WRR , enter the queue weight here. Bandwidth is divided across the different traffic queues according to their weights. Queues with larger weights get more service than queues with smaller weights.

Table 46 Queuing Method (continued)

LABEL	DESCRIPTION
Apply	Click Apply to save your changes to the switch's run-time memory. The switch loses these changes if it is turned off or loses power, so use the Save link on the top navigation panel to save your changes to the non-volatile memory when you are done configuring.
Cancel	Click Cancel to begin configuring this screen afresh.
Calculate	Click Calculate to make sure the WFQ queuing weights total to 100%; if not an error message is displayed.

CHAPTER 21

VLAN Stacking

This chapter shows you how to configure VLAN stacking on your switch. See the chapter on VLANs for more background information on Virtual LAN

21.1 VLAN Stacking Overview

A service provider can use VLAN stacking to allow it to distinguish multiple customers VLANs, even those with the same (customer-assigned) VLAN ID, within its network.

Use VLAN stacking to add an outer VLAN tag to the inner IEEE 802.1Q tagged frames that enter the network. By tagging the tagged frames (“double-tagged” frames), the service provider can manage up to 4,094 VLAN groups with each group containing up to 4,094 customer VLANs. This allows a service provider to provide different service, based on specific VLANs, for many different customers.

A service provider’s customers may require a range of VLANs to handle multiple applications. A service provider’s customers can assign their own inner VLAN tags on ports for these applications. The service provider can assign an outer VLAN tag for each customer. Therefore, there is no VLAN tag overlap among customers, so traffic from different customers is kept separate.

21.1.1 VLAN Stacking Example

In the following example figure, both **A** and **B** are Service Provider’s Network (SPN) customers with VPN tunnels between their head offices and branch offices respectively. Both have an identical VLAN tag for their VLAN group. The service provider can separate these two VLANs within its network by adding tag 37 to distinguish customer **A** and tag 48 to distinguish customer **B** at edge device **1** and then stripping those tags at edge device **2** as the data frames leave the network.

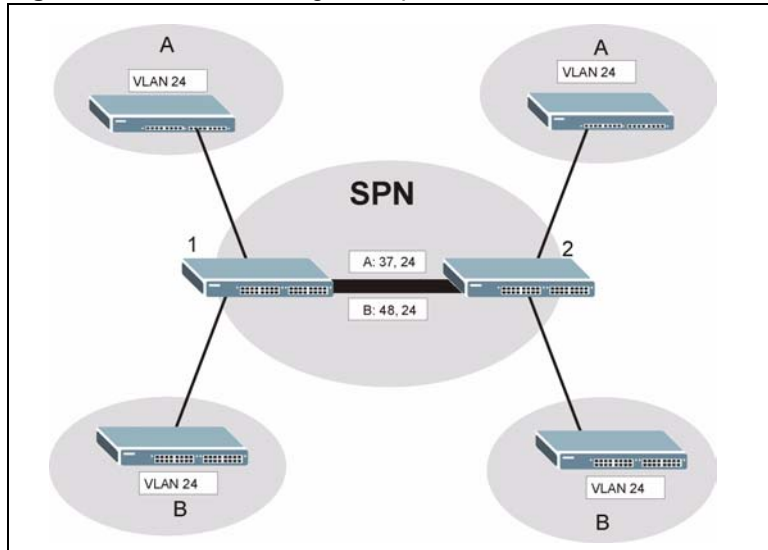
Figure 66 VLAN Stacking Example

21.2 VLAN Stacking Port Roles

Each port can have three VLAN stacking “roles”, **Normal**, **Access Port** and **Tunnel** (the latter is for Gigabit ports only).

- Select **Normal** for “regular” (non-VLAN stacking) IEEE 802.1Q frame switching.
- Select **Access Port** for ingress ports on the service provider's edge devices (**1** and **2** in the VLAN stacking example figure). The incoming frame is treated as "untagged", so a second VLAN tag (outer VLAN tag) can be added.

Note: Static VLAN Tx Tagging MUST be disabled on a port where you choose **Normal** or **Access Port**.

- Select **Tunnel Port** (available for Gigabit ports only) for egress ports at the edge of the service provider's network. All VLANs belonging to a customer can be aggregated into a single service provider's VLAN (using the outer VLAN tag defined by SP VID).

Note: Static VLAN Tx Tagging MUST be enabled on a port where you choose **Tunnel Port**.

21.3 VLAN Tag Format

A VLAN tag (service provider VLAN stacking or customer IEEE 802.1Q) consists of the following three fields.

Table 47 VLAN Tag Format

Type	Priority	VID
------	----------	-----

Type is a standard Ethernet type code identifying the frame and indicates that whether the frame carries IEEE 802.1Q tag information. **SP TPID** (Service Provider Tag Protocol Identifier) is the service provider VLAN stacking tag type. Many vendors use 0x8100 or 0x9100.

TPID (Tag Protocol Identifier) is the customer IEEE 802.1Q tag.

- If the VLAN stacking port role is **Access Port**, then the switch adds the **SP TPID** tag to all incoming frames on the service provider's edge devices (1 and 2 in the VLAN stacking example figure).
- If the VLAN stacking port role is **Tunnel Port**, then the switch only adds the **SP TPID** tag to all incoming frames on the service provider's edge devices (1 and 2 in the VLAN stacking example figure) that have an **SP TPID** different to the one configured on the switch. (If an incoming frame's **SP TPID** is the same as the one configured on the switch, then the switch will not add the tag.)

Priority refers to the IEEE 802.1p standard that allows the service provider to prioritize traffic based on the class of service (CoS) the customer has paid for.

- On the switch, configure priority level of inner IEEE 802.1Q tag in the **Port Setup** screen.
- "0" is the lowest priority level and "7" is the highest.

VID is the VLAN ID. **SP VID** is the VID for the second (service provider's) VLAN tag.

21.3.1 Frame Format

The frame format for an untagged Ethernet frame, a single-tagged 802.1Q frame (customer) and a "double-tagged" 802.1Q frame (service provider) is shown next.

Configure the fields as circled in the switch **VLAN Stacking** screen.

Table 48 Single and Double Tagged 802.11Q Frame Format

						DA	SA	Len/Etype	Data	FCS	Untagged Ethernet frame
			DA	SA	TPID	Priority	VID	Len/Etype	Data	FCS	IEEE 802.1Q customer tagged frame
DA	SA	SPTPID	Priority	VID	TPID	Priority	VID	Len/Etype	Data	FCS	Double-tagged frame

Table 49 802.1Q Frame

DA	Destination Address	Priority	802.1p Priority
SA	Source Address	Len/Etype	Length and type of Ethernet frame
(SP)TPID	(Service Provider) Tag Protocol Identifier	Data	Frame data
VID	VLAN ID	FCS	Frame Check Sequence

21.4 Configuring VLAN Stacking

Click **Advanced Applications** and then **VLAN Stacking** to display the screen as shown.

Figure 67 VLAN Stacking

Port	Role	SPVID	Priority
*	Access Port		0
1	Access Port	1	0
2	Access Port	1	0
3	Access Port	1	0
4	Access Port	1	0
5	Access Port	1	0
6	Access Port	1	0
7	Access Port	1	0
8	Access Port	1	0

The following table describes the labels in this screen.

Table 50 VLAN Stacking

LABEL	DESCRIPTION
Active	Select this checkbox to enable VLAN stacking on the switch.
SP TPID	SP TPID is a standard Ethernet type code identifying the frame and indicates whether the frame carries IEEE 802.1Q tag information. Choose 0x8100 or 0x9100 from the drop-down list box or select Others and then enter a four-digit hexadecimal number from 0x0000 to 0xFFFF. 0x denotes a hexadecimal number. It does not have to be typed in the Others text field.
Port	The port number identifies the port you are configuring.
*	Settings in this row apply to all ports. Use this row only if you want to make some settings the same for all ports. Use this row first to set the common settings and then make adjustments on a port-by-port basis. Note: Changes in this row are copied to all the ports as soon as you make them.

Table 50 VLAN Stacking (continued)

LABEL	DESCRIPTION
Role	<p>Select Normal to have the switch ignore frames received (or transmitted) on this port with VLAN stacking tags. Anything you configure in SPVID and Priority are ignored.</p> <p>Select Access Port to have the switch add the SP TPID tag to all incoming frames received on this port. Select Access Port for ingress ports at the edge of the service provider's network.</p> <p>Select Tunnel Port (available for Gigabit ports only) for egress ports at the edge of the service provider's network.</p> <p>In order to support VLAN stacking on a port, the port must be able to allow frames of 1526 Bytes (1522 Bytes + 4 Bytes for the second tag) to pass through it.</p>
SPVID	<p>SPVID is the service provider's VLAN ID (the outer VLAN tag). Enter the service provider ID (from 1 to 4094) for frames received on this port. See Chapter 8 on page 81 for more background information on VLAN ID.</p>
Priority	<p>On the switch, configure priority level of inner IEEE 802.1Q tag in the Port Setup screen. "0" is the lowest priority level and "7" is the highest.</p>
Apply	<p>Click Apply to save your changes to the switch's run-time memory. The switch loses these changes if it is turned off or loses power, so use the Save link on the top navigation panel to save your changes to the non-volatile memory when you are done configuring.</p>
Cancel	<p>Click Cancel to begin configuring this screen afresh.</p>

CHAPTER 22

Multicast

This chapter shows you how to configure various multicast features.

22.1 Multicast Overview

Traditionally, IP packets are transmitted in one of either two ways - Unicast (1 sender to 1 recipient) or Broadcast (1 sender to everybody on the network). Multicast delivers IP packets to just a group of hosts on the network.

IGMP (Internet Group Multicast Protocol) is a network-layer protocol used to establish membership in a multicast group - it is not used to carry user data. Refer to RFC 1112 and RFC 2236 for information on IGMP versions 1 and 2 respectively.

22.1.1 IP Multicast Addresses

In IPv4, a multicast address allows a device to send packets to a specific group of hosts (multicast group) in a different subnetwork. A multicast IP address represents a traffic receiving group, not individual receiving devices. IP addresses in the Class D range (224.0.0.0 to 239.255.255.255) are used for IP multicasting. Certain IP multicast numbers are reserved by IANA for special purposes (see the IANA web site for more information).

22.1.2 IGMP Filtering

With the IGMP filtering feature, you can control which IGMP groups a subscriber on a port can join. This allows you to control the distribution of multicast services (such as content information distribution) based on service plans and types of subscription.

You can set the switch to filter the multicast group join reports on a per-port basis by configuring an IGMP filtering profile and associating the profile to a port.

22.1.3 IGMP Snooping

A switch can passively snoop on IGMP Query, Report and Leave (IGMP version 2) packets transferred between IP multicast routers/switches and IP multicast hosts to learn the IP multicast group membership. It checks IGMP packets passing through it, picks out the group registration information, and configures multicasting accordingly. IGMP snooping allows the switch to learn multicast groups without you having to manually configure them.

The switch forwards multicast traffic destined for multicast groups (that it has learned from IGMP snooping or that you have manually configured) to ports that are members of that group. IGMP snooping generates no additional network traffic, allowing you to significantly reduce multicast traffic passing through your switch.

22.2 Multicast Status

Click **Advanced Applications** and **Multicast** to display the screen as shown. This screen shows the multicast group information. See [Section 22.1 on page 153](#) for more information on multicasting.

Figure 68 Multicast: Status

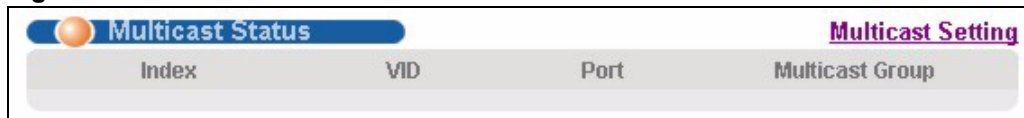

The following table describes the labels in this screen.

Table 51 Multicast Status

LABEL	DESCRIPTION
Index	This is the index number of the entry.
VID	This field displays the multicast VLAN ID.
Port	This field displays the port number that belongs to the multicast group.
Multicast Group	This field displays IP multicast group addresses.

22.3 Multicast Setting

Click **Advanced Applications**, **Multicast** and the **Multicast Setting** link to display the screen as shown. See [Section 22.1 on page 153](#) for more information on multicasting.

Figure 69 Multicast: Setting

Multicast Setting		Multicast Status	IGMP Filtering Profile	MVR	
IGMP Snooping		Active <input type="checkbox"/>	Host Timeout <input type="text" value="260"/>	Leave Timeout <input type="text" value="2"/>	
			802.1p Priority <input type="text" value="No-Change"/>		
IGMP Filtering		Active <input type="checkbox"/>			
Unknown Multicast Frame		<input checked="" type="radio"/> Flooding	<input type="radio"/> Drop		
Reserved Multicast Group		<input checked="" type="radio"/> Flooding	<input type="radio"/> Drop		
Port	Immed. Leave	Group Limited	Max Group Num.	IGMP Filtering Profile	IGMP Querier Mode
*	<input type="checkbox"/>	<input type="checkbox"/>	<input type="text" value=""/>	<input type="text" value="Default"/>	<input type="text" value="Auto"/>
1	<input type="checkbox"/>	<input type="checkbox"/>	<input type="text" value="0"/>	<input type="text" value="Default"/>	<input type="text" value="Auto"/>
2	<input type="checkbox"/>	<input type="checkbox"/>	<input type="text" value="0"/>	<input type="text" value="Default"/>	<input type="text" value="Auto"/>
3	<input type="checkbox"/>	<input type="checkbox"/>	<input type="text" value="0"/>	<input type="text" value="Default"/>	<input type="text" value="Auto"/>
4	<input type="checkbox"/>	<input type="checkbox"/>	<input type="text" value="0"/>	<input type="text" value="Default"/>	<input type="text" value="Auto"/>
5	<input type="checkbox"/>	<input type="checkbox"/>	<input type="text" value="0"/>	<input type="text" value="Default"/>	<input type="text" value="Auto"/>
6	<input type="checkbox"/>	<input type="checkbox"/>	<input type="text" value="0"/>	<input type="text" value="Default"/>	<input type="text" value="Auto"/>
7	<input type="checkbox"/>	<input type="checkbox"/>	<input type="text" value="0"/>	<input type="text" value="Default"/>	<input type="text" value="Auto"/>
8	<input type="checkbox"/>	<input type="checkbox"/>	<input type="text" value="0"/>	<input type="text" value="Default"/>	<input type="text" value="Auto"/>
				<input type="text" value="Apply"/>	<input type="text" value="Cancel"/>

The following table describes the labels in this screen.

Table 52 Multicast Setting

LABEL	DESCRIPTION
IGMP Snooping	Use these settings to configure IGMP Snooping.
Active	Select Active to enable IGMP Snooping to forward group multicast traffic only to ports that are members of that group.
Host Timeout	Specify the time (from 1 to 16,711,450) in seconds that elapses before the switch removes an IGMP group membership entry if it does not receive report messages from the port.
Leave Timeout	Enter an IGMP leave timeout value (from 1 to 16,711,450) in seconds. This defines how many seconds the switch waits for an IGMP report before removing an IGMP snooping membership entry when an IGMP leave message is received from a host.
802.1p Priority	Select a priority level (0-7) to which the switch changes the priority in outgoing IGMP control packets. Otherwise, select No-Change to not replace the priority.
IGMP Filtering	Select Active to enable IGMP filtering to control which IGMP groups a subscriber on a port can join.
Unknown Multicast Frame	Specify the action to perform when the switch receives an unknown multicast frame. Select Drop to discard the frame(s). Select Flooding to send the frame(s) to all ports.

Table 52 Multicast Setting (continued)

LABEL	DESCRIPTION
Reserved Multicast Group	<p>Multicast addresses (224.0.0.0 to 224.0.0.255) are reserved for the local scope. For examples, 224.0.0.1 is for all hosts in this subnet, 224.0.0.2 is for all multicast routers in this subnet, etc. A router will not forward a packet with the destination IP address within this range. See the IANA web site for more information.</p> <p>Specify the action to perform when the switch receives a frame with a reserved multicast address. Select Drop to discard the frame(s). Select Flooding to send the frame(s) to all ports.</p>
Port	This field displays the port number.
*	<p>Settings in this row apply to all ports.</p> <p>Use this row only if you want to make some settings the same for all ports. Use this row first to set the common settings and then make adjustments on a port-by-port basis.</p> <p>Note: Changes in this row are copied to all the ports as soon as you make them.</p>
Immed. Leave	<p>Select this option to set the switch to remove this port from the multicast tree when an IGMP version 2 leave message is received on this port.</p> <p>Select this option if there is only one host connected to this port.</p>
Group Limited	Select this option to limit the number of multicast groups this port is allowed to join.
Max Group Num.	Enter the number of multicast groups this port is allowed to join. Once a port is registered in the specified number of multicast groups, any new IGMP join report frame(s) is dropped on this port.
IGMP Filtering Profile	Select the name of the IGMP filtering profile to use for this port. Otherwise, select Default to prohibit the port from joining any multicast group.
IGMP Querier Mode	<p>The switch treats an IGMP query port as being connected to an IGMP multicast router (or server). The switch forwards IGMP join or leave packets to an IGMP query port.</p> <p>Select Auto to have the switch use the port as an IGMP query port if the port receives IGMP query packets.</p> <p>Select Fixed to have the switch always use the port as an IGMP query port. Select this when you connect an IGMP multicast server to the port.</p> <p>Select Edge to stop the switch from using the port as an IGMP query port. The switch will not keep any record of an IGMP router being connected to this port. The switch does not forward IGMP join or leave packets to this port.</p>
Apply	Click Apply to save your changes to the switch's run-time memory. The switch loses these changes if it is turned off or loses power, so use the Save link on the top navigation panel to save your changes to the non-volatile memory when you are done configuring.
Cancel	Click Cancel to reset the fields.

22.4 IGMP Filtering Profile

IGMP filter profiles allow you to control access to IGMP multicast groups. This allows you to have a service available to a specific IGMP multicast group. You can configure an IGMP filter profile for an IGMP multicast group that has access to a service (like a SIP server for example). Within a profile, configure an IGMP filter to specify the multicast IP address ranges. Then assign the IGMP filter profile to the ports (in the **Multicast Setting** screen) that are allowed to use the service.

Click **Advanced Applications** and **Multicast** in the navigation panel. Click the **Multicast Setting** link and then the **IGMP Filtering Profile** link to display the screen as shown.

Figure 70 Multicast: Setting: IGMP Filtering Profile

The following table describes the labels in this screen.

Table 53 Multicast: IGMP Filtering Profile

LABEL	DESCRIPTION
Profile Name	Enter a descriptive name for the profile for identification purposes. To configure additional rule(s) for a profile that you have already added, enter the profile name and specify a different IP multicast address range.
Start Address	Type the starting multicast IP address for a range of multicast IP addresses that you want to belong to the IGMP filter profile.
End Address	Type the ending multicast IP address for a range of IP addresses that you want to belong to the IGMP filter profile. If you want to add a single multicast IP address, enter it in both the Start Address and End Address fields.
Add	Click Add to save the profile to the switch's run-time memory. The switch loses these changes if it is turned off or loses power, so use the Save link on the top navigation panel to save your changes to the non-volatile memory when you are done configuring.
Clear	Click Clear to clear the fields to the factory defaults.
Profile Name	This field displays the descriptive name of the profile.
Start Address	This field displays the start of the multicast address range.
End Address	This field displays the end of the multicast address range.

Table 53 Multicast: IGMP Filtering Profile (continued)

LABEL	DESCRIPTION
Delete	To delete the profile(s) and all the accompanying rules, select the profile(s) that you want to remove in the Delete Profile column, then click the Delete button. To delete a rule(s) from a profile, select the rule(s) that you want to remove in the Delete Rule column, then click the Delete button.
Cancel	Click Cancel to clear the Delete Profile/Delete Rule check boxes.

22.5 MVR Overview

Multicast VLAN Registration (MVR) is designed for applications (such as Media-on-Demand (MoD)) that use multicast traffic across an Ethernet ring-based service provider network.

MVR allows one single multicast VLAN to be shared among different subscriber VLANs on the network. While isolated in different subscriber VLANs, connected devices can subscribe to and unsubscribe from the multicast stream in the multicast VLAN. This improves bandwidth utilization with reduced multicast traffic in the subscriber VLANs and simplifies multicast group management.

You must enable IGMP snooping to use MVR. However, MVR only responds to IGMP join and leave control messages from multicast groups that are configured under MVR. Join and leave reports from other multicast groups are managed by IGMP snooping.

The following figure shows a network example. The subscriber VLAN (**1, 2 and 3**) information is hidden from the streaming media server, **S**. In addition, the multicast VLAN information is only visible to the switch and **S**.

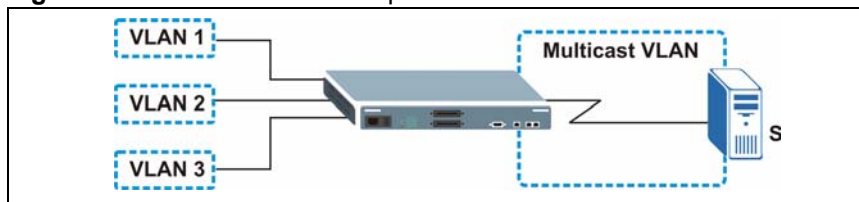
Figure 71 MVR Network Example

22.5.1 Types of MVR Ports

In MVR, a source port is a port on the switch that can send and receive multicast traffic in a multicast VLAN while a receiver port can only receive multicast traffic. Once configured, the switch maintains a forwarding table that matches the multicast stream to the associated multicast group.

22.5.2 MVR Modes

You can set your switch to operate in either dynamic or compatible mode.

In dynamic mode, the switch sends IGMP leave and join reports to the other multicast devices (such as multicast routers or servers) in the multicast VLAN. This allows the multicast devices to update the multicast forwarding table to forward or not forward multicast traffic to the receiver ports.

In compatible mode, the switch does not send any IGMP reports. In this case, you must manually configure the forwarding settings on the multicast devices in the multicast VLAN.

22.5.3 How MVR Works

The following figure shows a multicast television example where a subscriber device (such as a computer) in VLAN 1 receives multicast traffic from the streaming media server, S, via the switch. Multiple subscriber devices can connect through a port configured as the receiver on the switch.

When the subscriber selects a television channel, computer A sends an IGMP report to the switch to join the appropriate multicast group. If the IGMP report matches one of the configured MVR multicast group addresses on the switch, an entry is created in the forwarding table on the switch. This maps the subscriber VLAN to the list of forwarding destinations for the specified multicast traffic.

When the subscriber changes the channel or turns off the computer, an IGMP leave message is sent to the switch to leave the multicast group. The switch sends a query to VLAN 1 on the receiver port (in this case, a DSL port on the switch). If there is another subscriber device connected to this port in the same subscriber VLAN, the receiving port will still be on the list of forwarding destination for the multicast traffic. Otherwise, the switch removes the receiver port from the forwarding table.

Figure 72 MVR Multicast Television Example

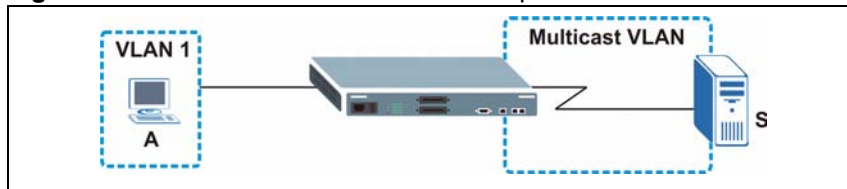

22.6 General MVR Configuration

Use the **MVR** screen to create multicast VLANs and select the receiver port(s) and a source port for each multicast VLAN. Click **Advanced Applications** and **Multicast** in the navigation panel. Click the **Multicast Setting** link and then the **MVR** link to display the screen as shown next.

Note: You can create up to three multicast VLANs and up to 256 multicast rules on the switch.

Your switch automatically creates a static VLAN (with the same VID) when you create a multicast VLAN in this screen.

Note: You can create up to three multicast VLANs and up to 256 multicast rules on the switch.

Your switch automatically creates a static VLAN (with the same VID) when you create a multicast VLAN in this screen.

Figure 73 Multicast: Setting: MVR

The following table describes the related labels in this screen.

Table 54 MVR

LABEL	DESCRIPTION
Active	Select this check box to enable MVR to allow one single multicast VLAN to be shared among different subscriber VLANs on the network.
Name	Enter a descriptive name (up to 32 printable ASCII characters) for identification purposes.
Multicast VLAN ID	Enter the VLAN ID (1 to 4094) of the multicast VLAN.
802.1p Priority	Select a priority level (0-7) with which the switch replaces the priority in outgoing IGMP control packets (belonging to this multicast VLAN).
Mode	Specify the MVR mode on the switch. Choices are Dynamic and Compatible . Select Dynamic to send IGMP reports to all MVR source ports in the multicast VLAN. Select Compatible to set the switch not to send IGMP reports.

Table 54 MVR (continued)

LABEL	DESCRIPTION
Port	This field displays the port number on the switch.
*	Settings in this row apply to all ports. Use this row only if you want to make some settings the same for all ports. Use this row first to set the common settings and then make adjustments on a port-by-port basis. Note: Changes in this row are copied to all the ports as soon as you make them.
Source Port	Select this option to set this port as the MVR source port that sends and receives multicast traffic. All source ports must belong to a single multicast VLAN.
Receiver Port	Select this option to set this port as a receiver port that only receives multicast traffic.
None	Select this option to set the port not to participate in MVR. No MVR multicast traffic is sent or received on this port.
Tagging	Select this checkbox if you want the port to tag the VLAN ID in all outgoing frames transmitted.
Add	Click Add to save your changes to the switch's run-time memory. The switch loses these changes if it is turned off or loses power, so use the Save link on the top navigation panel to save your changes to the non-volatile memory when you are done configuring.
Cancel	Click Cancel to reset the fields.
VLAN	This field displays the multicast VLAN ID.
Active	This field displays whether the multicast group is enabled or not.
Name	This field displays the descriptive name for this setting.
Mode	This field displays the MVR mode.
Source Port	This field displays the source port number(s).
Receiver Port	This field displays the receiver port number(s).
802.1p	This field displays the priority level.
Delete	To delete a multicast VLAN(s), select the rule(s) that you want to remove in the Delete column, then click the Delete button.
Cancel	Click Cancel to clear the Delete check boxes.

22.7 MVR Group Configuration

All source ports and receiver ports belonging to a multicast group can receive multicast data sent to this multicast group.

Configure MVR IP multicast group address(es) in the **Group Configuration** screen. Click **Group Configuration** in the **MVR** screen.

Note: A port can belong to more than one multicast VLAN. However, IP multicast group addresses in different multicast VLANs cannot overlap.

Figure 74 MVR: Group Configuration

The following table describes the labels in this screen.

Table 55 MVR: Group Configuration

LABEL	DESCRIPTION
Multicast VLAN ID	Select a multicast VLAN ID (that you configured in the MVR screen) from the drop-down list box.
Name	Enter a descriptive name for identification purposes.
Start Address	Enter the starting IP multicast address of the multicast group in dotted decimal notation. Refer to Section 22.1.1 on page 153 for more information on IP multicast addresses.
End Address	Enter the ending IP multicast address of the multicast group in dotted decimal notation. Enter the same IP address as the Start Address field if you want to configure only one IP address for a multicast group. Refer to Section 22.1.1 on page 153 for more information on IP multicast addresses.
Add	Click Add to save your changes to the switch's run-time memory. The switch loses these changes if it is turned off or loses power, so use the Save link on the top navigation panel to save your changes to the non-volatile memory when you are done configuring.
Cancel	Click Cancel to reset the fields.
MVLAN	This field displays the multicast VLAN ID.
Name	This field displays the descriptive name for this setting.
Start Address	This field displays the starting IP address of the multicast group.
End Address	This field displays the ending IP address of the multicast group.
Delete	Select Delete Group and click Delete to remove the selected entry(ies) from the table.
Cancel	Select Cancel to clear the checkbox(es) in the table.

22.7.1 MVR Configuration Example

The following figure shows a network example where ports 1, 2 and 3 on the switch belong to VLAN 1. In addition, port 7 belongs to the multicast group with VID 200 to receive multicast traffic (the **News** and **Movie** channels) from the remote streaming media server, **S**. Computers A, B and C in VLAN are able to receive the traffic.

Figure 75 MVR Configuration Example

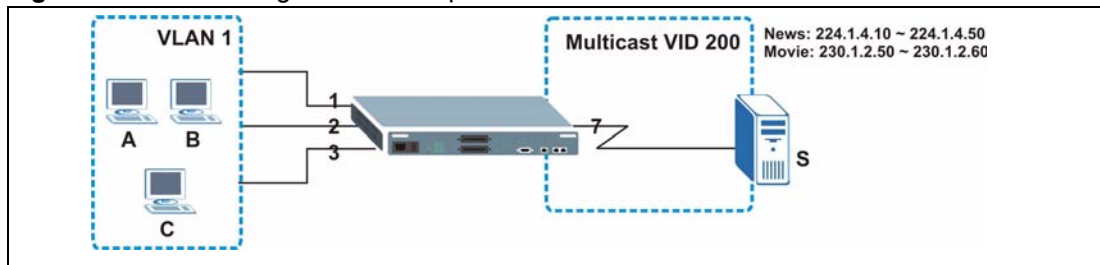

To configure the MVR settings on the switch, create a multicast group in the **MVR** screen and set the receiver and source ports.

Figure 76 MVR Configuration Example

MVR Multicast Setting [Group Configuration](#)

Active

Name

Multicast VLAN ID

Mode Dynamic Compatible

Port	Source Port	Receiver Port	None	Tagging
1	<input type="radio"/>	<input checked="" type="radio"/>	<input type="radio"/>	<input type="checkbox"/>
2	<input type="radio"/>	<input checked="" type="radio"/>	<input type="radio"/>	<input type="checkbox"/>
3	<input type="radio"/>	<input checked="" type="radio"/>	<input type="radio"/>	<input type="checkbox"/>
4	<input type="radio"/>	<input type="radio"/>	<input checked="" type="radio"/>	<input type="checkbox"/>
5	<input type="radio"/>	<input type="radio"/>	<input checked="" type="radio"/>	<input type="checkbox"/>
6	<input type="radio"/>	<input type="radio"/>	<input checked="" type="radio"/>	<input type="checkbox"/>
7	<input checked="" type="radio"/>	<input type="radio"/>	<input type="radio"/>	<input checked="" type="checkbox"/>
8	<input type="radio"/>	<input type="radio"/>	<input checked="" type="radio"/>	<input type="checkbox"/>

To set the switch to forward the multicast group traffic to the subscribers, configure multicast group settings in the **Group Configuration** screen. The following figure shows an example where two multicast groups (**News** and **Movie**) are configured for the multicast VLAN 200.

Figure 77 MVR Group Configuration Example

The screenshot shows the 'Group Configuration' interface for MVR. At the top, there is a 'Multicast VLAN ID' dropdown menu set to '200'. Below this is a table for adding new groups. The table has three columns: 'Name', 'Start Address', and 'End Address'. A single row is present with 'Movie' in the Name column, '230.1.2.50' in the Start Address column, and '230.1.2.60' in the End Address column. This row is circled in red. Below the table are 'Add' and 'Cancel' buttons. At the bottom, there is a summary table with columns: 'MVLAN', 'Name', 'Start Address', 'End Address', 'Delete All', and 'Delete Group'. The first row shows '200' in the MVLAN column, 'News' in the Name column, '224.1.4.10' in the Start Address column, '224.1.4.50' in the End Address column, and checkboxes in the 'Delete All' and 'Delete Group' columns. Below this table are 'Delete' and 'Cancel' buttons.

Name	Start Address	End Address
Movie	230.1.2.50	230.1.2.60

MVLAN	Name	Start Address	End Address	Delete All	Delete Group
200	News	224.1.4.10	224.1.4.50	<input type="checkbox"/>	<input type="checkbox"/>

Figure 78 MVR Group Configuration Example

The screenshot shows the 'Group Configuration' interface for MVR. At the top, there is a 'Multicast VLAN ID' dropdown menu set to '200'. Below this is a table for adding new groups. The table has three columns: 'Name', 'Start Address', and 'End Address'. A single row is present with an empty Name field, '0.0.0.0' in the Start Address column, and '0.0.0.0' in the End Address column. Below the table are 'Add' and 'Cancel' buttons. At the bottom, there is a summary table with columns: 'MVLAN', 'Name', 'Start Address', 'End Address', 'Delete All', and 'Delete Group'. The first row shows '200' in the MVLAN column, 'Movie' in the Name column, '230.1.2.50' in the Start Address column, '230.1.2.60' in the End Address column, and checkboxes in the 'Delete All' and 'Delete Group' columns. The second row shows '200' in the MVLAN column, 'News' in the Name column, '224.1.4.10' in the Start Address column, '224.1.4.50' in the End Address column, and checkboxes in the 'Delete All' and 'Delete Group' columns. This entire summary table is circled in red. Below this table are 'Delete' and 'Cancel' buttons.

Name	Start Address	End Address
	0.0.0.0	0.0.0.0

MVLAN	Name	Start Address	End Address	Delete All	Delete Group
200	Movie	230.1.2.50	230.1.2.60	<input type="checkbox"/>	<input type="checkbox"/>
200	News	224.1.4.10	224.1.4.50	<input type="checkbox"/>	<input type="checkbox"/>

CHAPTER 23

Static Route

This chapter shows you how to configure static routes.

23.1 Configuring Static Routing

Static routes tell the switch how to forward IP traffic when you configure the TCP/IP parameters manually.

Click **IP Application**, **Static Routing** in the navigation panel to display the screen as shown.

Figure 79 Static Routing

The screenshot shows the 'Static Routing' configuration page. At the top, there is a title bar with a 'Static Routing' label. Below it, there are several input fields: 'Active' with a checkbox, 'Name' with a text box, 'Destination IP Address' with a text box containing '0.0.0.0', 'IP Subnet Mask' with a text box containing '0.0.0.0', 'Gateway IP Address' with a text box containing '0.0.0.0', and 'Metric' with a text box. Below these fields are three buttons: 'Add', 'Cancel', and 'Clear'. Underneath the buttons is a table with the following data:

Index	Active	Name	Destination Address	Subnet Mask	Gateway Address	Metric	Delete
1	Yes	Example	172.21.1.1	255.255.0.0	192.168.1.2	2	<input type="checkbox"/>

Below the table are two buttons: 'Delete' and 'Cancel'.

The following table describes the related labels you use to create a static route.

Table 56 Static Routing

LABEL	DESCRIPTION
Active	This field allows you to activate/deactivate this static route.
Name	Enter a descriptive name (up to 32 printable ASCII characters) for identification purposes.
Destination IP Address	This parameter specifies the IP network address of the final destination. Routing is always based on network number. If you need to specify a route to a single host, use a subnet mask of 255.255.255.255 in the subnet mask field to force the network number to be identical to the host ID.
IP Subnet Mask	Enter the subnet mask for this destination.
Gateway IP Address	Enter the IP address of the gateway. The gateway is an immediate neighbor of your switch that will forward the packet to the destination. The gateway must be a router on the same segment as your switch.

Table 56 Static Routing (continued)

LABEL	DESCRIPTION
Metric	The metric represents the “cost” of transmission for routing purposes. IP routing uses hop count as the measurement of cost, with a minimum of 1 for directly connected networks. Enter a number that approximates the cost for this link. The number need not be precise, but it must be between 1 and 15. In practice, 2 or 3 is usually a good number.
Add	Click Add to insert a new static route to the switch’s run-time memory. The switch loses these changes if it is turned off or loses power, so use the Save link on the top navigation panel to save your changes to the non-volatile memory when you are done configuring.
Cancel	Click Cancel to reset the above fields to your previous configuration.
Clear	Click Clear to set the above fields back to the factory defaults.
Index	This field displays the index number of the route. Click a number to edit the static route entry.
Active	This field displays Yes when the static route is activated and NO when it is deactivated.
Name	This field displays the descriptive name for this route. This is for identification purpose only.
Destination Address	This field displays the IP network address of the final destination.
Subnet Mask	This field displays the subnet mask for this destination.
Gateway Address	This field displays the IP address of the gateway. The gateway is an immediate neighbor of your switch that will forward the packet to the destination.
Metric	This field displays the cost of transmission for routing purposes.
Delete	Click Delete to remove the selected entry from the summary table.
Cancel	Click Cancel to clear the Delete check boxes.

CHAPTER 24

RIP

This chapter shows you how to configure RIP (Routing Information Protocol).

24.1 RIP Overview

RIP (Routing Information Protocol) allows a routing device to exchange routing information with other routers. The **Direction** field controls the sending and receiving of RIP packets. When set to:

- **Both** - the switch will broadcast its routing table periodically and incorporate the RIP information that it receives.
- **Incoming** - the switch will not send any RIP packets but will accept all RIP packets received.
- **Outgoing** - the switch will send out RIP packets but will not accept any RIP packets received.
- **None** - the switch will not send any RIP packets and will ignore any RIP packets received.

The **Version** field controls the format and the broadcasting method of the RIP packets that the switch sends (it recognizes both formats when receiving). **RIP-1** is universally supported; but RIP-2 carries more information. **RIP-1** is probably adequate for most networks, unless you have an unusual network topology.

Both **RIP-2B** and **RIP-2M** send the routing data in RIP-2 format; the difference being that **RIP-2B** uses subnet broadcasting while **RIP-2M** uses multicasting.

24.2 Configuring RIP

Click **IP Application, RIP** in the navigation panel to display the screen as shown. You cannot manually configure a new entry. Each entry in the table is automatically created when you configure a new IP domain in the **IP Setup** screen (refer to [Section 7.6 on page 75](#)).

Figure 80 RIP

Index	Network	Direction	Version
1	192.168.1.1/24	None	RIP-1

The following table describes the labels in this screen.

Table 57 RIP

LABEL	DESCRIPTION
Active	Select this check box to enable RIP on the switch.
Index	This field displays the index number of an IP interface.
Network	This field displays the IP interface configured on the switch. Refer to the section on IP Setup for more information on configuring IP domains.
Direction	Select the RIP direction from the drop-down list box. Choices are Outgoing , Incoming , Both and None .
Version	Select the RIP version from the drop-down list box. Choices are RIP-1 , RIP-2B and RIP-2M .
Apply	Click Apply to save your changes to the switch's run-time memory. The switch loses these changes if it is turned off or loses power, so use the Save link on the top navigation panel to save your changes to the non-volatile memory when you are done configuring.
Cancel	Click Cancel to begin configuring the fields again.

CHAPTER 25

OSPF

This chapter describes the OSPF (Open Shortest Path First) routing protocol and shows you how to configure OSPF.

25.1 OSPF Overview

OSPF (Open Shortest Path First) is a link-state protocol designed to distribute routing information within an autonomous system (AS). An autonomous system is a collection of networks using a common routing protocol to exchange routing information.

OSPF offers some advantages over traditional vector-space routing protocols (such as RIP). The following table summarizes some of the major differences between OSPF and RIP.

Table 58 OSPF vs. RIP

	OSPF	RIP
Network Size	Large	Small (with up to 15 routers)
Metrics	Bandwidth, hop count, throughput, round trip time and reliability.	Hop count
Convergence	Fast	Slow

25.1.1 OSPF Autonomous Systems and Areas

An OSPF autonomous system can be divided into logical areas. Each area represents a group of adjacent networks. All areas are connected to a backbone (also known as area 0). The backbone is the transit area to route packets between two areas. A stub area, at the edge of an AS, is not a transit area since there is only one connection to the stub area.

The following table describes the four classes of OSPF routers.

Table 59 OSPF: Router Types

TYPE	DESCRIPTION
Internal Router (IR)	An Internal or intra-area router is a router in an area.
Area Border Router (ABR)	An Area Border Router connects two or more areas.
Backbone Router (BR)	A backbone router has an interface to the backbone.
AS Boundary Router	An AS boundary router exchanges routing information with routers in other ASes.

The following figure depicts an OSPF network example. The backbone is area 0 with a backbone router. The internal routers are in area 1 and 2. The area border routers connect area 1 and 2 to the backbone.

Figure 81 OSPF Network Example

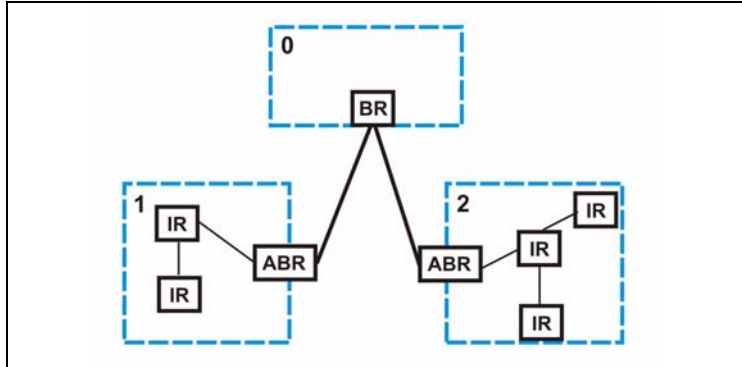

25.1.2 How OSPF Works

Layer 3 devices exchange routing information to build synchronized link state database within the same AS or area. They do this by exchanging Hello messages to confirm which neighbor (layer 3) devices exist and then they exchange database descriptions (DDs) to create the link state database. The link state database is constantly updated through LSAs (Link State Advertisements).

The link state database contains records of router IDs, their associated links and path costs. Each device can then use the link state database and Dijkstra algorithm to compute the least cost paths to network destinations.

25.1.3 Interfaces and Virtual Links

An OSPF interface is a link between a layer 3 device and an OSPF network. An interface has state information, an IP address and subnet mask associated with it. When you configure an OSPF interface, you first set an interface to transmit OSPF traffic and add the interface to an area.

You can configure a virtual link to establish/maintain connectivity between a non-backbone area and the backbone. The virtual link must be configured on both layer 3 devices in the non-backbone area and the backbone.

25.1.4 OSPF and Router Elections

The OSPF protocol provides for automatic election of Designated Router (DR) and Backup Designated Router (BDR) on network segments. The DR and BDR keep track of link state updates in their area and make sure LSAs are sent to the rest of the network.

In most cases the default DR/BDR election is fine, but in some situations it must be controlled. In the following figure only router **A** has direct connectivity with all the other routers on the network segment. Routers **B** and **C** do not have a direct connection with each other. Therefore they should not be allowed to become DR or BDR. Only router **A** should become the DR.

Figure 82 OSPF Router Election Example

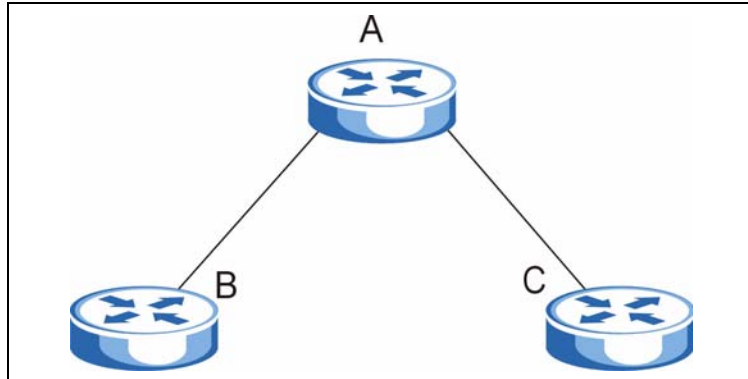

You can assign a priority to an interface which determines whether this router will be elected to be a DR or BDR. The router with the highest priority becomes the DR, while a router with a priority of 0 does not participate in router elections. In [Figure 82 on page 171](#) you can assign a priority of 0 to routers **B** and **C**, thereby ensuring they do not become DR or BDR and assign a priority of 1 to router **A** to make sure that it does become the DR.

25.1.5 Configuring OSPF

To configure OSPF on the switch, do the following tasks

- 1 Enable OSPF
- 2 Create OSPF areas
- 3 Create and associate interface(s) to an area
- 4 Create virtual links to maintain backbone connectivity.

25.2 OSPF Status

Use this screen to view current OSPF status. Click **IP Application, OSPF** in the navigation panel to display the screen as shown next. See [Section 25.1 on page 169](#) for more information on OSPF.

Figure 83 OSPF Status

OSPF Status [Configuration](#)

OSPF: Running

Interface:

```

VLINK0 is down, line protocol is down
  OSPF is enabled, but not running on this interface
swif2 is up, line protocol is up
  Internet Address 192.168.1.10/24, Area 192.168.1.1
  Router ID 192.168.1.10, Network Type BROADCAST, Cost: 15
  Transmit Delay is 1 sec, State Backup, Priority 1
  
```

Neighbor:

Neighbor ID	Pri	State	Dead Time	Address	Interface
192.168.1.1	1	Full/DR	00:00:34	192.168.1.1	swif2:192.168.

Link State Database:

```

OSPF Router with ID (192.168.1.10)
  Router Link States (Area 0.0.0.0)
  Link ID      ADV Router    Age  Seq#    CkSum  Link count
  
```

Poll Interval(s)

The following table describes the labels in this screen.

Table 60 OSPF Status

LABEL	DESCRIPTION
OSPF	This field displays whether OSPF is activated (Running) or not (Down).
Interface	The text box displays the OSPF status of the interface(s) on the switch.
Neighbor	The text box displays the status of the neighboring router participating in the OSPF network.
Link State Database	The text box displays information in the link state database which contains data in the LSAs.
Poll Interval(s)	The text box displays how often (in seconds) this screen refreshes. You may change the refresh interval by typing a new number in the text box and then clicking Set Interval .
Stop	Click Stop to end OSPF status polling.

The following table describes some common output fields.

Table 61 OSPF Status: Common Output Fields

FIELD	DESCRIPTION
Interface	
Internet Address	This field displays the IP address and subnet bits of an IP routing domain.

Table 61 OSPF Status: Common Output Fields (continued)

FIELD	DESCRIPTION
Area	This field displays the area ID.
Router ID	This field displays the unique ID of the switch.
Transmit Delay	This field displays the transmission delay in seconds.
State	This field displays the state of the switch (backup or DR (designated router)).
Priority	This field displays the priority of the switch. This number is used in the designated router election.
Designated Router	This field displays the router ID of the designated router.
Backup Designated Router	This field displays the router ID of a backup designated router.
Time Intervals Configured	This field displays the time intervals (in seconds) configured.
Neighbor Count	This field displays the number of neighbor routers.
Adjacent Neighbor Count	This field displays the number of neighbor router(s) that is adjacent to the switch.
Neighbor	
Neighbor ID	This field displays the router ID of the neighbor.
Pri	This field displays the priority of the neighbor. This number is used in the designated router election.
State	This field displays the state of the neighbor (backup or DR (designated router)).
Dead Time	This field displays the dead time in seconds.
Address	This field displays the IP address of a neighbor.
Interface	This field displays the MAC address of a device.
Link State Database	
Link ID	This field displays the ID of a router or subnet.
ADV Router	This field displays the IP address of the layer-3 device that sends the LSAs.
Age	This field displays the time (in seconds) since the last LSA was sent.
Seq #	This field displays the link sequence number of the LSA.
Checksum	This field displays the checksum value of the LSA.
Link Count	This field displays the number of links in the LSA.

25.3 OSPF Configuration

Use this screen to activate OSPF and set general settings. Click **IP Application**, **OSPF** and the **Configuration** link to display the **OSPF Configuration** screen. See [Section 25.1 on page 169](#) for more information on OSPF.

OSPF Configuration: Activating and General Settings

OSPF Configuration Interface Virtual-Link Status

Active

Router ID

Redistribute Route	Active	Type	Metric value
RIP	<input checked="" type="checkbox"/>	1	15
Static	<input checked="" type="checkbox"/>	1	15

Apply Cancel

Name

Area ID

Authentication

Stub Network

No Summary

Default route cost

Add Cancel Clear

Index	Name	Area ID	Authentication	Stub Network	Delete
-------	------	---------	----------------	--------------	--------

Delete Cancel

The follow table describes the related labels in this screen.

Table 62 OSPF Configuration: Activating and General Settings

LABEL	DESCRIPTION
Active	OSPF is disabled by default. Select this option to enable it.
Router ID	Router ID uniquely identifies the switch in an OSPF. Enter a unique ID (that uses the format of an IP address in dotted decimal notation) for the switch.
Redistribute Route	Route redistribution allows your switch to import and translate external routes learned through other routing protocols (RIP and Static) into the OSPF network transparently.
Active	Select this option to activate route redistribution for routes learn through the selected protocol.
Type	Select 1 for routing protocols (such as RIP) whose external metrics are directly comparable to the internal OSPF cost. When selecting a path, the internal OSPF cost is added to the AB boundary router to the external metrics. Select 2 for routing protocols whose external metrics are not comparable to the OSPF cost. In this case, the external cost of the AB boundary router is used in path decision to a destination.
Metric Value	Enter a route cost (between 0 and 16777214).
Apply	Click Apply to save your changes to the switch's run-time memory. The switch loses these changes if it is turned off or loses power, so use the Save link on the top navigation panel to save your changes to the non-volatile memory when you are done configuring.
Cancel	Click Cancel to start configuring the above fields again.

25.4 Configure OSPF Areas

To ensure that the switch receives only routing information from a trusted layer 3 devices, activate authentication. The OSPF supports three authentication methods:

- None – no authentication is used.
- Simple – authenticate link state updates using an 8 printable ASCII character password.
- MD5 – authenticate link state updates using a 16 printable ASCII character password.

To configure an area, set the related fields in the **OSPF Configuration** screen.

Figure 84 OSPF Configuration: Area Setup

The following table describes the related labels in this screen.

Table 63 OSPF Configuration: Area Setup

LABEL	DESCRIPTION
Name	Enter a descriptive name (up to 32 printable ASCII characters) for identification purposes.
Area ID	Enter a 32-bit ID (that uses the format of an IP address in dotted decimal notation) that uniquely identifies an area. A value of 0.0.0.0 indicates that this is a backbone (also known as Area 0). You can create only one backbone area on the switch.

Table 63 OSPF Configuration: Area Setup (continued)

LABEL	DESCRIPTION
Authentication	Select an authentication method (Simple or MD5) to activate authentication. Select None (default) to disable authentication. Usually interface(s) and virtual interface(s) should use the same authentication method as the associated area. If interface(s) and virtual interface(s) use different authentication methods than the associated area, the authentication methods are based on the interface(s) and virtual interface(s) settings.
Stub Network	Select this option to set the area as a stub area. If you enter 0.0.0.0 in the Area ID field, the settings in the Stub Area fields are ignored.
No Summary	Select this option to set the switch to not send/receive LSAs.
Default Route Cost	Specify a cost (between 0 and 16777214) used to add a default route into a stub area for routes which are external to an OSPF domain. If you do not set a route cost, no default route is added.
Add	Click Add to save your changes to the switch's run-time memory. The switch loses these changes if it is turned off or loses power, so use the Save link on the top navigation panel to save your changes to the non-volatile memory when you are done configuring.
Cancel	Click Cancel to start configuring the above fields again.
Clear	Click Clear to set the above fields back to the factory defaults.

25.4.1 View OSPF Area Information Table

The bottom of the **OSPF Configuration** screen displays a summary table of all the OSPF areas you have configured.

Figure 85 OSPF Configuration: Summary Table

Index	Name	Area ID	Authentication	Stub Network	Delete
1	Example	192.168.1.1	None	No	<input type="checkbox"/>

The following table describes the related labels in this screen.

Table 64 OSPF Configuration: Summary Table

LABEL	DESCRIPTION
Index	This field displays the index number of an area.
Name	This field displays the descriptive name of an area.
Area ID	This field displays the area ID (that uses the format of an IP address in dotted decimal notation) that uniquely identifies an area. An area ID of 0.0.0.0 indicates the backbone.
Authentication	This field displays the authentication method used (None , Simple or MD5).
Stub Network	This field displays whether an area is a stub network (Yes) or not (No).
Delete	Click Delete to remove the selected entry from the summary table.
Cancel	Click Cancel to clear the Delete check boxes.

25.5 Configuring OSPF Interfaces

To configure an OSPF interface, first create an IP routing domain in the **IP Setup** screen (see [Section 7.6 on page 75](#) for more information). Once you create an IP routing domain, an OSPF interface entry is automatically created. See [Section 25.1 on page 169](#) for more information on OSPF.

In the **OSPF Configuration** screen, click **Interface** to display the **OSPF Interface** screen.

Figure 86 OSPF Interface

Index	Network	Area ID	Authentication	Key ID	Cost	Priority	Delete
1	192.168.1.1/24	192.168.1.1	None	1	15	111	<input type="checkbox"/>

The following table describes the labels in this screen.

Table 65 OSPF Interface

LABEL	DESCRIPTION
Network	Select an IP interface.
Area ID	Select the area ID (that uses the format of an IP address in dotted decimal notation) of an area to associate the interface to that area.
Authentication	<p>Note: OSPF Interface(s) must use the same authentication method within the same area.</p> <p>Select an authentication method. Choices are Same-as-Area, None (default), Simple and MD5.</p> <p>To participate in an OSPF network, you must set the authentication method and/or password the same as the associated area.</p> <p>Select Same-as-Area to use the same authentication method within the area and set the related fields when necessary.</p> <p>Select None to disable authentication. This is the default setting.</p> <p>Select Simple and set the Key field to authenticate OSPF packets transmitted through this interface using simple password authentication.</p> <p>Select MD5 and set the Key ID and Key fields to authenticate OSPF packets transmitted through this interface using MD5 authentication.</p>

Table 65 OSPF Interface (continued)

LABEL	DESCRIPTION
Key ID	When you select MD5 in the Authentication field, specify the identification number of the authentication you want to use.
Key	When you select Simple in the Authentication field, enter a password eight-character long. Characters after the eighth character will be ignored. When you select MD5 in the Authentication field, enter a password 16-character long.
Cost	The interface cost is used for calculating the routing table. Enter a number between 0 and 65535. The default interface cost is 15.
Priority	The priority you assign to the interface is used in router elections to decide which router is going to be the Designated Router (DR) or the Backup Designated Router (BDR). You can assign a number between 0 and 255. A priority of 0 means that the router will not participate in router elections.
Add	Click Add to save your changes to the switch's run-time memory. The switch loses these changes if it is turned off or loses power, so use the Save link on the top navigation panel to save your changes to the non-volatile memory when you are done configuring.
Cancel	Click Cancel to start configuring the above fields again.
Clear	Click Clear to set the above fields back to the factory defaults.
Index	This field displays the index number for an interface.
Network	This field displays the IP interface information.
Area ID	This field displays the area ID (that uses the format of an IP address in dotted decimal notation) of an area to associate the interface to that area.
Authentication	This field displays the authentication method used (Same-as-Area , None , Simple or MD5).
Key ID	When the Authentication field displays MD5 , this field displays the identification number of the key used.
Cost	This field displays the interface cost used for calculating the routing table.
Priority	This field displays the priority for this OSPF interface.
Delete	Click Delete to remove the selected entry from the summary table.
Cancel	Click Cancel to start configuring the above fields again.

25.6 OSPF Virtual-Links

Configure and view virtual link settings in this screen. See [Section 25.1 on page 169](#) for more information on OSPF.

In the **OSPF Configuration** screen, click **Virtual-Link** to display the screen as shown next.

Figure 87 OSPF Virtual Link

The following table describes the related labels in this screen.

Table 66 OSPF Virtual-Link

LABEL	DESCRIPTION
Name	Enter a descriptive name (up to 32 printable ASCII characters) for identification purposes.
Area ID	Select the area ID (that uses the format of an IP address in dotted decimal notation) of an area to associate the interface to that area.
Peer Router ID	Enter the ID of a peer border router.
Authentication	<p>Note: Virtual interface(s) must use the same authentication method within the same area.</p> <p>Select an authentication method. Choices are Same-as-Area, None (default), Simple and MD5.</p> <p>To exchange OSPF packets with peer border router, you must set the authentication method and/or password the same as the peer border router.</p> <p>Select Same-as-Area to use the same authentication method within the area and set the related fields when necessary.</p> <p>Select None to disable authentication. This is the default setting.</p> <p>Select Simple to authenticate OSPF packets transmitted through this interface using a simple password.</p> <p>Select MD5 to authenticate OSPF packets transmitted through this interface using MD5 authentication.</p>
Key ID	When you select MD5 in the Authentication field, specify the identification number of the authentication you want to use.
Key	When you select Simple in the Authentication field, enter a password eight-character long. When you select MD5 in the Authentication field, enter a password 16-character long.
Add	Click Add to save your changes to the switch's run-time memory. The switch loses these changes if it is turned off or loses power, so use the Save link on the top navigation panel to save your changes to the non-volatile memory when you are done configuring.
Cancel	Click Cancel to start configuring the above fields again.

Table 66 OSPF Virtual-Link (continued)

LABEL	DESCRIPTION
Clear	Click Clear to set the above fields back to the factory defaults.
Index	This field displays an index number of an entry.
Name	This field displays a descriptive name of a virtual link.
Peer Router ID	This field displays the ID (that uses the format of an IP address in dotted decimal notation) of a peer border router.
Authentication	This field displays the authentication method used (Same-as-Area , None , Simple or MD5).
Key ID	When the Authentication field displays MD5 , this field displays the identification number of the key used.
Delete	Click Delete to remove the selected entry from the summary table.
Cancel	Click Cancel to clear the Delete check boxes.

CHAPTER 26

IGMP

This chapter shows you how to configure IGMP.

26.1 IGMP Overview

IGMP (Internet Group Multicast Protocol) is a session-layer protocol used to establish membership in a multicast group - it is not used to carry user data. Refer to RFC 1112 and RFC 2236 for information on IGMP versions 1 and 2 respectively.

The switch supports both IGMP version 1 (**IGMP-v1**) and version 2 (**IGMP-v2**). At start up, the switch queries all directly connected networks to gather group membership. After that, the switch periodically updates this information.

26.2 Configuring IGMP

Click **IP Application**, **IGMP** in the navigation panel to display the screen as shown next. Each entry in the table is automatically created when you configure a new IP domain in the **IP Setup** screen (refer to [Section 7.6 on page 75](#)).

Figure 88 IGMP

Index	Network	Version
1	172.21.4.73/16	None
2	192.168.1.1/24	None

The following table describes the labels in this screen.

Table 67 IGMP

LABEL	DESCRIPTION
Active	Select this check box to enable IGMP on the switch. Note: You <i>cannot</i> enable both IGMP snooping and IGMP at the same time. Refer to the section on IGMP snooping.
Index	This field displays an index number of an entry.

Table 67 IGMP (continued)

LABEL	DESCRIPTION
Network	This field displays the IP domain configured on the switch. Refer to Section 7.6 on page 75 for more information on configuring IP domains.
Version	Select an IGMP version from the drop-down list box. Choices are IGMP-v1 , IGMP-v2 and None .
Apply	Click Apply to save your changes to the switch's run-time memory. The switch loses these changes if it is turned off or loses power, so use the Save link on the top navigation panel to save your changes to the non-volatile memory when you are done configuring.
Cancel	Click Cancel to begin configuring the fields again.

CHAPTER 27

DVMRP

This chapter introduces DVMRP and tells you how to configure it.

27.1 DVMRP Overview

DVMRP (Distance Vector Multicast Routing Protocol) is a protocol used for routing multicast data within an autonomous system (AS). This DVMRP implementation is based on draft-ietf-idmr-dvmrp-v3-10. DVMRP provides multicast forwarding capability to a layer 3 switch that runs both the IPv4 protocol (with IP Multicast support) and the IGMP protocol. The DVMRP metric is a hop count of 32.

IGMP is a protocol used for joining or leaving a multicast group. You must have IGMP enabled when you enable DVMRP; otherwise you see the screen as in [Figure 91 on page 185](#).

27.2 How DVMRP Works

DVMRP uses the Reverse Path Multicasting (RPM) algorithm to generate an IP Multicast delivery tree. Multicast packets are forwarded along these multicast tree branches. DVMRP dynamically learns host membership information using Internet Group Multicast Protocol (IGMP). The trees are updated dynamically to track the membership of individual groups.

- 1 Initially an advertisement multicast packet is broadcast (“B” in the following figure).
- 2 DVMRP-enabled Layer 3 devices that do not have any hosts in their networks that belong to this multicast group send back a prune message (“P”).
- 3 If hosts later join the multicast group, a graft message (“G”) to undo the prune is sent to the parent.
- 4 The final multicast (“M”) after pruning and grafting is shown in the next figure.

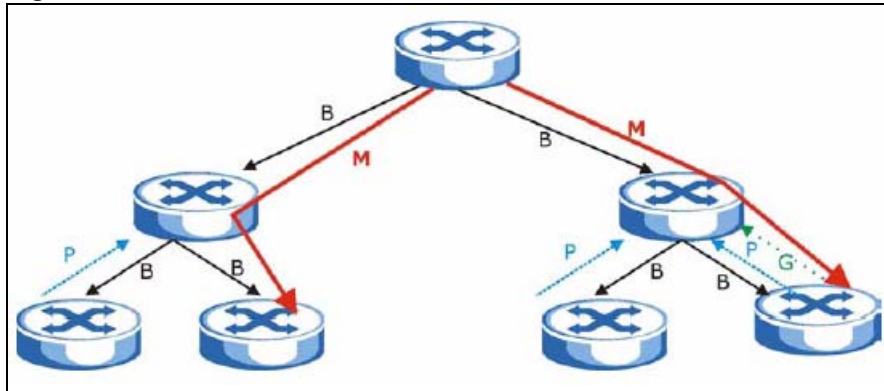
Figure 89 How DVMRP Works

27.2.1 DVMRP Terminology

DVMRP probes are used to discover other DVMRP Neighbors on a network.

DVMRP reports are used to exchange DVMRP source routing information. These packets are used to build the DVMRP multicast routing table that is used to build source trees and also perform Reverse Path Forwarding (RPF) checks on incoming multicast packets. RPF checks prevent duplicate packets being filtered when loops exist in the network topology.

DVMRP prunes trim the multicast delivery tree(s). DVMRP grafts attach a branch back onto the multicast delivery tree.

27.3 Configuring DVMRP

Configure DVMRP on the switch when you wish it to act as a multicast router (“mrouter”). Click **IP Application**, **DVMRP** in the navigation panel to display the screen as shown.

Figure 90 DVMRP

DVMRP			
Active	<input type="checkbox"/>		
Threshold	<input type="text" value="255"/>		
Index	Network	VID	Active
1	10.10.10.1/24	2	<input type="checkbox"/>
2	192.168.1.1/24	1	<input type="checkbox"/>
<input type="button" value="Apply"/> <input type="button" value="Cancel"/>			

The following table describes the labels in this screen.

Table 68 DVMRP

LABEL	DESCRIPTION
Active	Select Active to enable DVMRP on the switch. You should do this if you want the switch to act as a multicast router.
Threshold	Threshold is the maximum time to live (TTL) value. TTL is used to limit the scope of multicasting. You should reduce this value if you do not wish to flood Layer 3 devices many hops away with multicast traffic. This applies only to multicast traffic this switch sends out.
Index	Index is the DVMRP configuration for the IP routing domain defined under Network . The maximum number of DVMRP configurations allowed is the maximum number of IP routing domains allowed on the switch. See Section 7.6 on page 75 for more information on IP routing domains.
Network	This is the IP routing domain IP address and subnet mask you set up in IP Setup .
VID	DVMRP cannot be enabled on the same VLAN group across different IP routing domains, that is, you cannot have duplicate VIDs for different DVMRP configurations (see Figure 93 on page 186).
Active	Select Active to enable DVMRP on this IP routing domain.
Apply	Click Apply to save your changes to the switch's run-time memory. The switch loses these changes if it is turned off or loses power, so use the Save link on the top navigation panel to save your changes to the non-volatile memory when you are done configuring.
Cancel	Click Cancel to begin configuring this part of the screen afresh.

27.3.1 DVMRP Configuration Error Messages

You must have IGMP/RIP enabled when you enable DVMRP; otherwise you see the screen as in the next figure.

Figure 91 DVMRP: IGMP/RIP Not Set Error

When you disable IGMP, but DVMRP is still active you also see another warning screen.

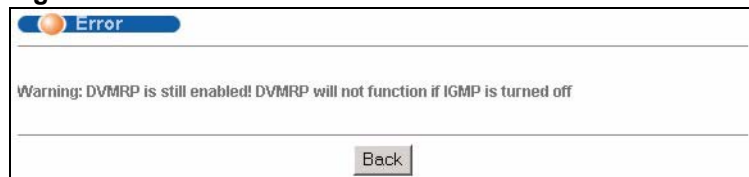
Figure 92 DVMRP: Unable to Disable IGMP Error

Each IP routing domain DVMRP configuration must be in a different VLAN group; otherwise you see the following screen.

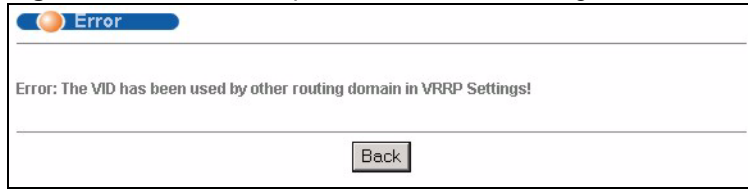
Figure 93 DVMRP: Duplicate VID Error Message

27.4 Default DVMRP Timer Values

The following are some default DVMRP timer values. These may be changed using line commands. Please see the commands chapter later in this User's Guide.

Table 69 DVMRP: Default Timer Values

DVMRP FIELD	DEFAULT VALUE
Probe interval	10 sec
Report interval	35 sec
Route expiration time	140 sec
Prune lifetime	Variable (less than two hours)
Prune retransmission time	3 sec with exponential back off
Graft retransmission time	5 sec with exponential back off

CHAPTER 28

IP Multicast

This chapter shows you how to configure the **IP Multicast** screen.

28.1 IP Multicast Overview

Traditionally, IP packets are transmitted in one of either two ways - Unicast (one sender to one recipient) or Broadcast (one sender to everybody on the network). IP Multicast is a third way to deliver IP packets to a group of hosts on the network - not everybody.

You can configure the switch to untag (remove the VLAN tags from) IP multicast packets that the switch forwards. This allows the switch to send packets to Ethernet devices that are not VLAN-aware.

28.2 Configuring Multicast

Click **IP Application** and **IP Multicast** in the navigation panel to display the screen as shown next.

Figure 94 IP Multicast

Port	IP Multicast Egress Untag Vlan ID
*	<input type="text"/>
1	0 <input type="text"/>
2	0 <input type="text"/>
3	0 <input type="text"/>
4	0 <input type="text"/>
5	0 <input type="text"/>
6	0 <input type="text"/>
7	0 <input type="text"/>
8	0 <input type="text"/>

Apply Cancel

The following table describes the labels in this screen.

Table 70 IP Multicast

LABEL	DESCRIPTION
Port	This read-only field displays the port number.
*	<p>Settings in this row apply to all ports.</p> <p>Use this row only if you want to make some settings the same for all ports. Use this row first to set the common settings and then make adjustments on a port-by-port basis.</p> <p>Note: Changes in this row are copied to all the ports as soon as you make them.</p>
IP Multicast Egress Untag Vlan ID	<p>The switch removes the VLAN tag from IP multicast packets belonging to the specified VLAN before transmission on this port.</p> <p>Enter a VLAN group ID in this field. Enter 0 to set the switch not to remove any VLAN tags from the packets.</p>
Apply	Click Apply to save your changes to the switch's run-time memory. The switch loses these changes if it is turned off or loses power, so use the Save link on the top navigation panel to save your changes to the non-volatile memory when you are done configuring.
Cancel	Click Cancel to reset the fields to your previous configuration.

CHAPTER 29

Differentiated Services

This chapter shows you how to configure Differentiated Services (DiffServ) on the switch.

29.1 DiffServ Overview

Quality of Service (QoS) is used to prioritize source-to-destination traffic flows. All packets in the flow are given the same priority. You can use CoS (class of service) to give different priorities to different packet types.

DiffServ is a class of service (CoS) model that marks packets so that they receive specific per-hop treatment at DiffServ-compliant network devices along the route based on the application types and traffic flow. Packets are marked with DiffServ Code Points (DSCPs) indicating the level of service desired. This allows the intermediary DiffServ-compliant network devices to handle the packets differently depending on the code points without the need to negotiate paths or remember state information for every flow. In addition, applications do not have to request a particular service or give advanced notice of where the traffic is going.

29.1.1 DSCP and Per-Hop Behavior

DiffServ defines a new DS (Differentiated Services) field to replace the Type of Service (ToS) field in the IP header. The DS field contains a 2-bit unused field and a 6-bit DSCP field which can define up to 64 service levels. The following figure illustrates the DS field.

DSCP is backward compatible with the three precedence bits in the ToS octet so that non-DiffServ compliant, ToS-enabled network device will not conflict with the DSCP mapping.

Figure 95 DiffServ: Differentiated Service Field

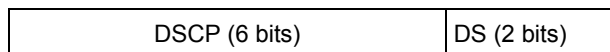

The DSCP value determines the forwarding behavior, the PHB (Per-Hop Behavior), that each packet gets across the DiffServ network. Based on the marking rule different kinds of traffic can be marked for different priorities of forwarding. Resources can then be allocated according to the DSCP values and the configured policies.

29.1.2 DiffServ Network Example

The following figure depicts a simple DiffServ network consisting of a group of contiguous DiffServ-compliant network devices.

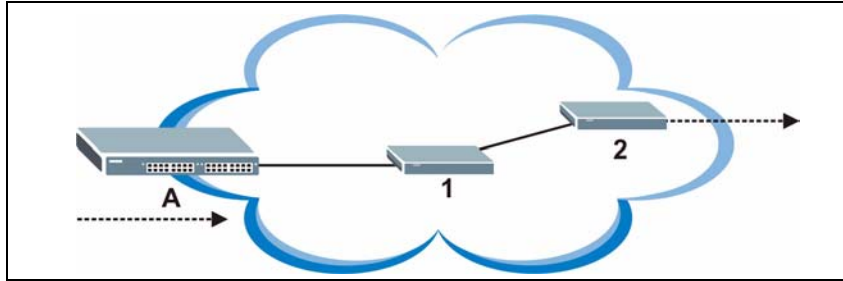
Figure 96 DiffServ Network Example

Switch **A** marks traffic flowing into the network based on the configured marking rules. Intermediary network devices **1** and **2** allocate network resources (such as bandwidth) by mapping the DSCP values and the associated policies.

29.2 Activating DiffServ

Activate DiffServ to allow the switch to enable DiffServ and apply marking rules and IEEE802.1p priority mapping on the selected port(s).

Click **IP Application**, **DiffServ** in the navigation panel to display the screen as shown.

Figure 97 DiffServ

Port	Active
*	<input type="checkbox"/>
1	<input checked="" type="checkbox"/>
2	<input checked="" type="checkbox"/>
3	<input checked="" type="checkbox"/>
4	<input checked="" type="checkbox"/>
5	<input checked="" type="checkbox"/>
6	<input checked="" type="checkbox"/>
7	<input checked="" type="checkbox"/>
8	<input checked="" type="checkbox"/>

The following table describes the labels in this screen.

Table 71 DiffServ

LABEL	DESCRIPTION
Active	Select this option to enable DiffServ on the switch.
Port	This field displays the index number of a port on the switch.

Table 71 DiffServ (continued)

LABEL	DESCRIPTION
*	Settings in this row apply to all ports. Use this row only if you want to make some settings the same for all ports. Use this row first to set the common settings and then make adjustments on a port-by-port basis. Note: Changes in this row are copied to all the ports as soon as you make them.
Active	Select this option to enable DiffServ on the port.
Apply	Click Apply to save your changes to the switch's run-time memory. The switch loses these changes if it is turned off or loses power, so use the Save link on the top navigation panel to save your changes to the non-volatile memory when you are done configuring.
Cancel	Click Cancel to start configuring this screen again.

29.3 DSCP-to-IEEE802.1p Priority Settings

You can configure the DSCP to IEEE802.1p mapping to allow the switch to prioritize all traffic based on the incoming DSCP value according to the DiffServ to IEEE802.1p mapping table.

The following table shows the default DSCP-to-IEEE802.1P mapping.

Table 72 Default DSCP-IEEE802.1p Mapping

DSCP Value	0 – 7	8 – 15	16 – 23	24 – 31	32 – 39	40 – 47	48 – 55	56 – 63
IEEE802.1P	0	1	2	3	4	5	6	7

29.3.1 Configuring DSCP Settings

To change the DSCP-IEEE 802.1p mapping click the **DSCP Setting** link in the **DiffServ** screen to display the screen as shown next.

Figure 98 DiffServ: DSCP Setting

DSCP Classification	802.1p Priority
0	0
1	0
2	0
3	0
4	0
5	0
6	0
7	0
8	1
9	1
10	1
11	1
12	1
13	1
14	1
15	1
16	2
17	2
18	2
19	2
20	2
21	2
22	2
23	2
24	3
25	3
26	3
27	3
28	3
29	3
30	3
31	3
32	4
33	4
34	4
35	4
36	4
37	4
38	4
39	4
40	5
41	5
42	5
43	5
44	5
45	5
46	5
47	5
48	6
49	6
50	6
51	6
52	6
53	6
54	6
55	6
56	7
57	7
58	7
59	7
60	7
61	7
62	7
63	7

The following table describes the labels in this screen.

Table 73 DiffServ: DSCP Setting

LABEL	DESCRIPTION
0 ... 63	This is the DSCP classification identification number. To set the IEEE802.1p priority mapping, select the priority level from the drop-down list box.
Apply	Click Apply to save your changes to the switch's run-time memory. The switch loses these changes if it is turned off or loses power, so use the Save link on the top navigation panel to save your changes to the non-volatile memory when you are done configuring.
Cancel	Click Cancel to discard all changes and start configuring the screen again.

CHAPTER 30

DHCP

This chapter shows you how to configure the DHCP feature.

30.1 DHCP Overview

DHCP (Dynamic Host Configuration Protocol RFC 2131 and RFC 2132) allows individual computers to obtain TCP/IP configuration at start-up from a server. You can configure the switch as a DHCP server or disable it. When configured as a server, the switch provides the TCP/IP configuration for the clients. If you disable the DHCP service, you must have another DHCP server on your LAN, or else the computer must be manually configured.

30.1.1 DHCP modes

The switch can be configured as a DHCP server or DHCP relay agent.

- If you configure the switch as a DHCP server, it will maintain the pool of addresses and distribute them to your LAN computers.
- If there is an Ethernet device that performs the DHCP server function for your network, then you can configure the switch as a DHCP relay agent. When the switch receives a request from a computer on your network, it contacts the Ethernet device (the DHCP server) for the necessary IP information, and then relays the assigned information back to the computer.

30.2 DHCP Server Status

Click **IP Application**, **DHCP** in the navigation panel. The **DHCP Server Status** screen displays.

Figure 99 DHCP: DHCP Server Status

Index	VID	Server Status	IP Pool Size
1	2	10.10.10.100	100

Polling Interval(s)

The following table describes the labels in this screen.

Table 74 DHCP: DHCP Server Status

LABEL	DESCRIPTION
Index	This is the index number.
VID	This field displays the ID number of the VLAN group to which this DHCP settings apply.
Server Status	This field displays the starting DHCP client IP address.
IP Pool Size	This field displays the size of the DHCP client IP address pool.
Poll Interval(s)	The text box displays how often (in seconds) this screen refreshes. You may change the refresh interval by typing a new number in the text box and then clicking Set Interval .
Stop	Click Stop to end status polling.

30.3 Configuring DHCP Server

Use this screen to configure your DHCP server settings. Click **IP Application, DHCP** in the navigation panel. Click the **Server** link In the **DHCP Server Status** screen that displays.

Figure 100 DHCP: Server

VID	Type	DHCP Status	Delete
2	Server	10.10.10.100/100	<input type="checkbox"/>

The following table describes the labels in this screen.

Table 75 DHCP: Server

LABEL	DESCRIPTION
VID	Enter the ID number of the VLAN group to which this DHCP settings apply.
Client IP Pool Starting Address	Specify the first of the contiguous addresses in the IP address pool.
Size of Client IP Pool	Specify the size, or count of the IP address pool.
IP Subnet Mask	Enter the subnet mask for the client IP pool.
Default Gateway	Enter the IP address of the default gateway device.
Primary/Secondary DNS Server	Enter the IP addresses of the DNS servers. The DNS servers are passed to the DHCP clients along with the IP address and the subnet mask.
Add	Click Add to save your changes to the switch's run-time memory. The switch loses these changes if it is turned off or loses power, so use the Save link on the top navigation panel to save your changes to the non-volatile memory when you are done configuring.
Cancel	Click Cancel to reset the fields to your previous configurations.
Clear	Click Clear to reset the fields back to the factory defaults.
VID	This field displays the ID number of the VLAN group to which this DHCP settings apply.
Type	This field displays Server for the DHCP mode.
DHCP Status	This field displays the starting and the size of DHCP client IP address.
Delete	Click Delete to remove the selected entry.
Cancel	Click Cancel to clear the Delete check boxes.

30.3.1 DHCP Server Configuration Example

The following figure shows a network example where the switch is used to assign network information to the DHCP clients in the **RD** and **Sales** network.

Figure 101 DHCP Server Network Example

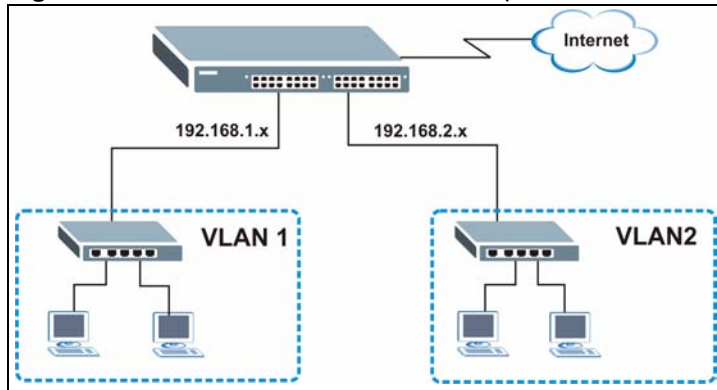

In the **DHCP Server** screen, configure two DHCP client IP address pools for the two networks. The following shows an example.

Figure 102 DHCP Server Configuration Example

DHCP Server		Status	
VID	2		
Client IP Pool Starting Address	192.168.2.100		
Size of Client IP Pool	100		
IP Subnet Mask	255.255.255.0		
Default Gateway	192.168.2.1		
Primary DNS Server	192.168.2.120		
Secondary DNS Server	0.0.0.0		
<input type="button" value="Add"/> <input type="button" value="Cancel"/> <input type="button" value="Clear"/>			
VID	Type	DHCP Status	Delete
1	Server	192.168.1.100/100	<input type="checkbox"/>
<input type="button" value="Delete"/> <input type="button" value="Cancel"/>			

30.4 DHCP Relay

Configure DHCP relay on the switch if the DHCP clients and the DHCP server are not in the same subnet. During the initial IP address leasing, the switch helps to relay network information (such as the IP address and subnet mask) between a DHCP client and a DHCP server. Once the DHCP client obtains an IP address and can connect to the network, network information renewal is done between the DHCP client and the DHCP server without the help of the switch.

30.4.1 DHCP Relay Agent Information

The switch can add information to client DHCP requests that it relays to a DHCP server. This helps provide authentication about the source of the requests. You can also specify additional information for the switch to add to the client DHCP requests that it relays to the DHCP server. Please refer to RFC 3046 for more details.

The DHCP relay agent information feature adds an Agent Information field to the option 82 field of the DHCP headers of client DHCP request frames that the switch relays to a DHCP server. The following lists the DHCP relay agent option 82 information that the switch sends to the DHCP server:

- Slot ID (1 byte)
- Port ID (1 byte)
- VLAN ID (2 bytes)
- System name (up to 32 bytes, this is optional)

30.4.2 Configuring DHCP Relay

Configure DHCP relay in the **DHCP Relay** screen. Click **IP Application**, **DHCP** in the navigation panel and click the **Relay** link to display the screen as shown.

Figure 103 DHCP: Relay

The following table describes the labels in this screen.

Table 76 DHCP: Relay

LABEL	DESCRIPTION
Active	Select this check box to enable DHCP relay.
Remote DHCP Server 1 .. 3	Enter the IP address of a DHCP server in dotted decimal notation.
Relay Agent Information	Select the Option 82 check box to have the switch add information (slot number, port number and VLAN ID) to client DHCP requests that it relays to a DHCP server.
Information	This read-only field displays the system name you configure in the General Setup screen. Select the check box for the switch to add the system name to the client DHCP requests that it relays to a DHCP server.

Table 76 DHCP: Relay (continued)

LABEL	DESCRIPTION
Apply	Click Apply to save your changes to the switch's run-time memory. The switch loses these changes if it is turned off or loses power, so use the Save link on the top navigation panel to save your changes to the non-volatile memory when you are done configuring.
Cancel	Click Cancel to discard all changes and start configuring the screen again.

30.4.3 DHCP Relay Configuration Example

The follow figure shows a network example where the switch is used to relay DHCP requests for the **RD** and **Sales** network. There is only one DHCP server that services the DHCP clients in both networks.

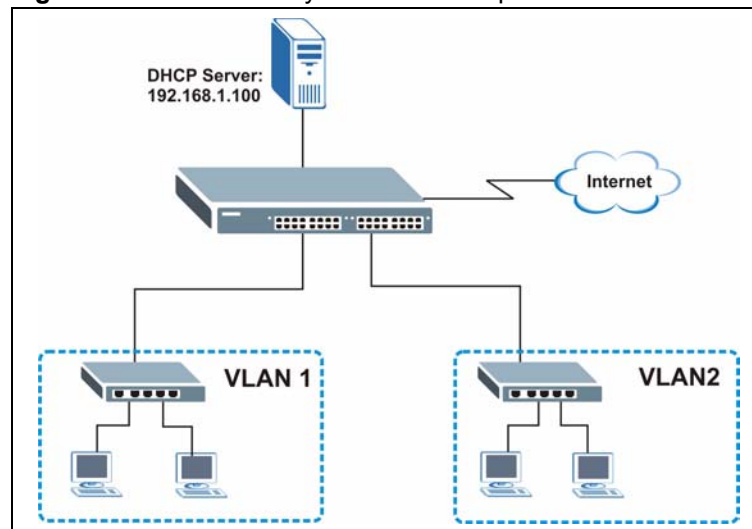
Figure 104 DHCP Relay Network Example

Configure the **DHCP Relay** screen as shown. Make sure you select the **Option 82** check box to set the switch to send additional information (such as the VLAN ID) together with the DHCP requests to the DHCP server. This allows the DHCP server to assign the appropriate IP address according to the VLAN ID.

Figure 105 DHCP Relay Configuration Example

The screenshot shows the DHCP Relay configuration interface. The 'Active' checkbox is checked. The 'Remote DHCP Server 1' field contains the IP address 192.168.1.100. The 'Remote DHCP Server 2' and 'Remote DHCP Server 3' fields both contain 0.0.0.0. In the 'Relay Agent Information' section, the 'Option 82' checkbox is checked, and the 'Information' field contains the text 'GS-4012F'. At the bottom of the screen, there are 'Apply' and 'Cancel' buttons.

CHAPTER 31

VRRP

This chapter shows you how to configure and monitor the Virtual Router Redundancy Protocol (VRRP) on the switch.

31.1 VRRP Overview

Each host on a network is configured to send packets to a statically configured default gateway (this switch). The default gateway can become a single point of failure. Virtual Router Redundancy Protocol (VRRP), defined in RFC 2338, allows you to create redundant backup gateways to ensure that the default gateway of a host is always available.

In VRRP, a virtual router (VR) represents a number of physical layer-3 devices. An IP address is associated with the virtual router. A layer-3 device having the same IP address is the preferred master router while the other Layer-3 devices are the backup routers. The master router forwards traffic for the virtual router. When the master router becomes unavailable, a backup router assumes the role of the master router until the master router comes back up and takes over.

The following figure shows a VRRP network example with the switches (**A** and **B**) implementing one virtual router **VR1** to ensure the link between the host **X** and the uplink gateway **G**. Host **X** is configured to use **VR1** (192.168.1.20) as the default gateway. If switch **A** has a higher priority, it is the master router. Switch **B**, having a lower priority, is the backup router.

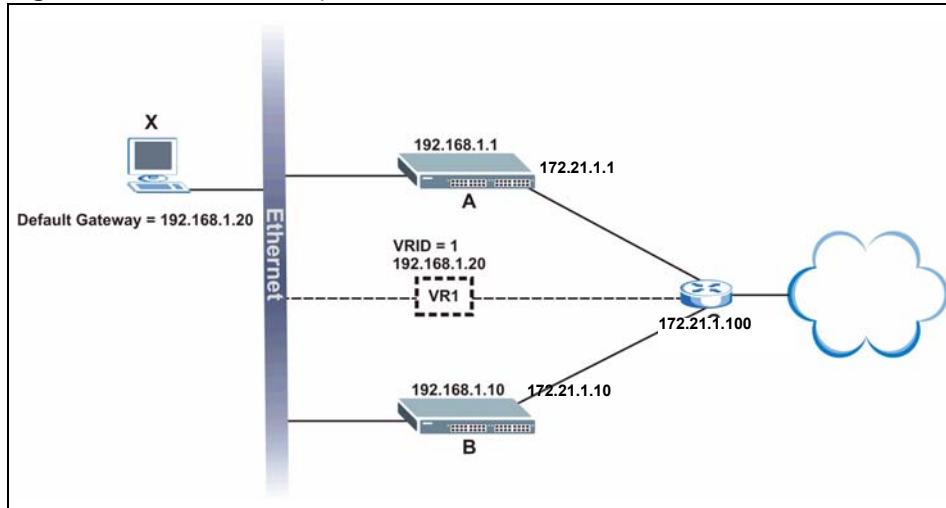
Figure 106 VRRP: Example 1

If switch **A** (the master router) is unavailable, switch **B** takes over. Traffic is then processed by switch **B**.

31.2 VRRP Status

Click **IP Application**, **VRRP** in the navigation panel to display the **VRRP Status** screen as shown next.

Figure 107 VRRP Status

Index	Network	VRID	VR Status	Uplink Status
1	192.168.1.1/24	1	Master	Alive

Poll Interval(s)

The following table describes the labels in this screen.

Table 77 VRRP Status

LABEL	DESCRIPTION
Index	This field displays the index number of a rule.
Network	This field displays the IP address and the subnet mask bits of an IP routing domain that is associated to a virtual router.
VRID	This field displays the ID number of the virtual router.
VR Status	This field displays the status of the virtual router. This field is Master indicating that this switch functions as the master router. This field is Backup indicating that this switch functions as a backup router. This field displays Init when this switch is initiating the VRRP protocol or when the Uplink Status field displays Dead .
Uplink Status	This field displays the status of the link between this switch and the uplink gateway. This field is Alive indicating that the link between this switch and the uplink gateway is up. Otherwise, this field is Dead . This field displays Probe when this switch is check for the link state.
Poll Interval(s)	The text box displays how often (in seconds) this screen refreshes. You may change the refresh interval by typing a new number in the text box and then clicking Set Interval .
Stop	Click Stop to halt system statistic polling.

31.3 VRRP Configuration

The following sections describe the different parts of the VRRP Configuration screen.

31.3.1 IP Interface Setup

Before configuring VRRP, first create an IP interface (or routing domain) in the **IP Setup** screen (see the [Section 7.6 on page 75](#) for more information).

Click **IP Application**, **VRRP** and click the **Configuration** link to display the **VRRP Configuration** screen as shown next.

Note: You can only configure VRRP on interfaces with unique VLAN IDs.

Routing domains with the same VLAN ID are not displayed in the table indicated.

Figure 108 VRRP Configuration: IP Interface

Index	Network	Authentication	Key
1	192.168.1.10/24	None	

Apply Cancel

Active

Name name

Network 192.168.1.10/24

Virtual Router ID 1

Advertisement Interval 1

Preempt Mode

Priority 100

Uplink Gateway 0.0.0.0

Primary Virtual IP 0.0.0.0

Secondary Virtual IP 0.0.0.0

Add Cancel Clear

Index	Active	Name	Network	VRID	Primary VIP	Uplink Gateway	Priority	Delete
1	Yes	Example	192.168.1.10/24	1	192.168.1.1	192.168.1.100	110	<input type="checkbox"/>

Delete Cancel

The following table describes the labels in this screen.

Table 78 VRRP Configuration: IP Interface

LABEL	DESCRIPTION
Index	This field displays the index number of an entry.
Network	This field displays the IP address and number of subnet mask bit of an IP domain.
Authentication	Select None to disable authentication. This is the default setting. Select Simple to use a simple password to authenticate VRRP packet exchanges on this interface.
Key	When you select Simple in the Authentication field, enter a password key (up to eight printable ASCII character long) in this field.

Table 78 VRRP Configuration: IP Interface (continued)

LABEL	DESCRIPTION
Apply	Click Apply to save your changes to the switch's run-time memory. The switch loses these changes if it is turned off or loses power, so use the Save link on the top navigation panel to save your changes to the non-volatile memory when you are done configuring.
Cancel	Click Cancel to discard all changes made in this table.

31.3.2 VRRP Parameters

This section describes the VRRP parameters.

31.3.2.1 Advertisement Interval

The master router sends out Hello messages to let the other backup routers know that it is still up and running. The time interval between sending the Hello messages is the advertisement interval. By default, a Hello message is sent out every second.

If the backup routers do not receive a Hello message from the master router after this interval expires, it is assumed that the master router is down. Then the backup router with the highest priority becomes the master router.

Note: All routers participating in the virtual router must use the same advertisement interval.

31.3.2.2 Priority

Configure the priority level (1 to 254) to set which backup router to take over in case the master router goes down. The backup router with the highest priority will take over. The priority of the VRRP router that owns the IP address(es) associated with the virtual router is 255.

31.3.2.3 Preempt Mode

If the master router is unavailable, a backup router assumes the role of the master router. However, when another backup router with a higher priority joins the network, it will preempt the lower priority backup router that is the master. Disable preempt mode to prevent this from happening.

By default, a layer 3 device with the same IP address as the virtual router will become the master router regardless of the preempt mode.

31.3.3 Configuring VRRP Parameters

After you set up an IP interface, configure the VRRP parameters in the **VRRP Configuration** screen.

Figure 109 VRRP Configuration: VRRP Parameters

The following table describes the labels in this screen.

Table 79 VRRP Configuration: VRRP Parameters

LABEL	DESCRIPTION
Active	Select this option to enable this VRRP entry.
Name	Enter a descriptive name (up to 32 printable ASCII characters) for identification purposes.
Network	Select an IP domain to which this VRRP entry applies.
Virtual Router ID	Select a virtual router number (1 to 7) for which this VRRP entry is created. You can configure up to seven virtual routers for one network.
Advertisement Interval	Specify the number of seconds between Hello message transmissions.
Preempt Mode	Select this option to activate preempt mode.
Priority	Enter a number (between 1 and 254) to set the priority level. The bigger the number, the higher the priority.
Uplink Gateway	Enter the IP address of the uplink gateway in dotted decimal notation. The switch checks the link to the uplink gateway.
Primary Virtual IP	Enter the IP address of the primary virtual router in dotted decimal notation.
Secondary Virtual IP	This field is optional. Enter the IP address of a secondary virtual router in dotted decimal notation. This field is ignored when you enter 0.0.0.0 .
Add	Click Add to save your changes to the switch's run-time memory. The switch loses these changes if it is turned off or loses power, so use the Save link on the top navigation panel to save your changes to the non-volatile memory when you are done configuring.
Cancel	Click Cancel to discard all changes made in this table.
Clear	Click Clear to set the above fields back to the factory defaults.

31.4 VRRP Configuration Summary

To view a summary of all VRRP configurations on the switch, scroll down to the bottom of the **VRRP Configuration** screen.

Figure 110 VRRP Configuration: Summary

Index	Active	Name	Network	VRID	Primary VIP	Uplink Gateway	Priority	Delete
1	Yes	Example	192.168.1.10/24	1	192.168.1.1	192.168.1.100	110	<input type="checkbox"/>

The following table describes the labels in this screen.

Table 80 VRRP Configuring: VRRP Parameters

LABEL	DESCRIPTION
Index	This field displays the index number of an entry.
Active	This field shows whether a VRRP entry is enabled (Yes) or disabled (No).
Name	This field displays a descriptive name of an entry.
Network	This field displays the IP address and subnet mask of an interface.
VRID	This field displays the ID number of a virtual router.
Primary VIP	This field displays the IP address of the primary virtual router.
Uplink Gateway	This field displays the IP address of the uplink gateway.
Priority	This field displays the priority level (1 to 255) of the entry.
Delete	Click Delete to remove the selected entry from the summary table.
Cancel	Click Cancel to clear the Delete check boxes.

31.5 VRRP Configuration Examples

The following sections show two VRRP configuration examples on the switch.

31.5.1 One Subnet Network Example

The figure below shows a simple VRRP network with only one virtual router **VR1** (VRID =1) and two switches. The network is connected to the WAN via an uplink gateway **G** (172.21.1.100). The host computer **X** is set to use **VR1** as the default gateway.

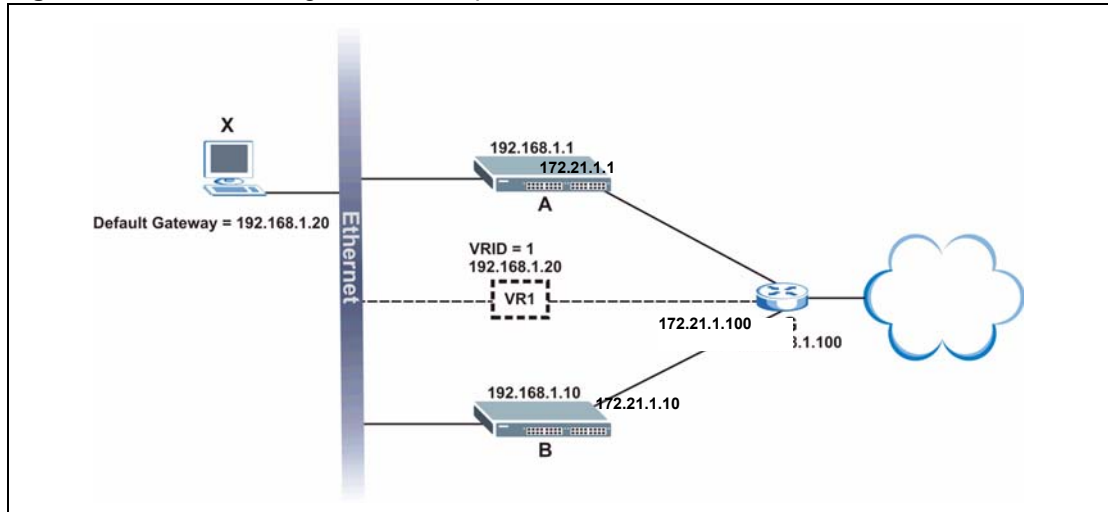
Figure 111 VRRP Configuration Example: One Virtual Router Network

You want to set switch **A** as the master router. Configure the VRRP parameters in the **VRRP Configuration** screens on the switches as shown in the figures below.

Figure 112 VRRP Example 1: VRRP Parameter Settings on Switch A

Active	<input checked="" type="checkbox"/>
Name	Example1
Network	192.168.1.1/24
Virtual Router ID	1
Advertisement Interval	1
Preempt Mode	<input checked="" type="checkbox"/>
Priority	110
Uplink Gateway	172.21.1.100
Primary Virtual IP	192.168.1.20
Secondary Virtual IP	0.0.0.0

Figure 113 VRRP Example 1: VRRP Parameter Settings on Switch B

Active	<input checked="" type="checkbox"/>
Name	Example1
Network	192.168.10.1/24
Virtual Router ID	1
Advertisement Interval	1
Preempt Mode	<input checked="" type="checkbox"/>
Priority	100
Uplink Gateway	172.21.1.100
Primary Virtual IP	192.168.1.20
Secondary Virtual IP	0.0.0.0

After configuring and saving the VRRP configuration, the **VRRP Status** screens for both switches are shown next.

Figure 114 VRRP Example 1: VRRP Status on Switch A

VRRP Status					Configuration
Index	Active	Network	VRID	VR Status	Uplink Status
1	Yes	192.168.1.1/24	1	Master	Alive

Figure 115 VRRP Example 1: VRRP Status on Switch B

VRRP Status					Configuration
Index	Active	Network	VRID	VR Status	Uplink Status
1	Yes	192.168.1.10/24	1	Backup	Alive

31.5.2 Two Subnets Example

The following figure depicts an example in which two switches share the network traffic. Hosts in the two network groups use different default gateways. Each switch is configured to backup a virtual router using VRRP.

You wish to configure switch **A** as the master router for virtual router **VR1** and as a backup for virtual router **VR2**. On the other hand, switch **B** is the master for **VR2** and a backup for **VR1**.

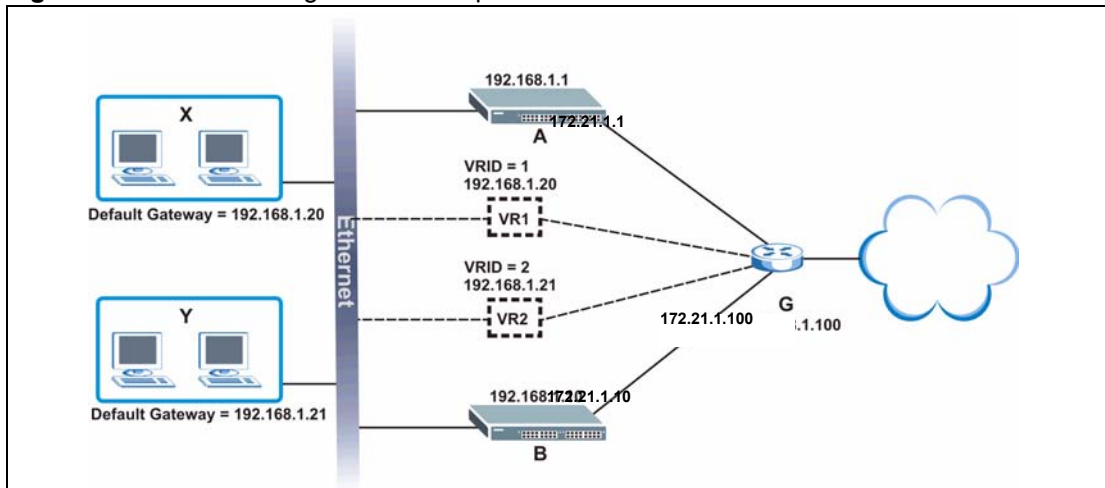
Figure 116 VRRP Configuration Example: Two Virtual Router Network

Keeping the VRRP configuration in example 1 for virtual router **VR1** (refer to [Section 31.5.2 on page 207](#)), you need to configure the **VRRP Configuration** screen for virtual router **VR2** on each switch. Configure the VRRP parameters on the switches as shown in the figures below.

Figure 117 VRRP Example 2: VRRP Parameter Settings for VR2 on Switch A

Active	<input checked="" type="checkbox"/>
Name	Example2
Network	192.168.1.1/24
Virtual Router ID	1
Advertisement Interval	1
Preempt Mode	<input checked="" type="checkbox"/>
Priority	100
Uplink Gateway	172.21.1.100
Primary Virtual IP	192.168.1.21
Secondary Virtual IP	0.0.0.0

Figure 118 VRRP Example 2: VRRP Parameter Settings for VR2 on Switch B

Active	<input checked="" type="checkbox"/>
Name	Example2
Network	192.168.10.1/24
Virtual Router ID	1
Advertisement Interval	1
Preempt Mode	<input checked="" type="checkbox"/>
Priority	110
Uplink Gateway	172.21.1.100
Primary Virtual IP	192.168.1.21
Secondary Virtual IP	0.0.0.0

After configuring and saving the VRRP configuration, the **VRRP Status** screens for both switches are shown next.

Figure 119 VRRP Example 2: VRRP Status on Switch A

VRRP Status						Configuration
Index	Active	Network	VRID	VR Status	Uplink Status	
1	Yes	192.168.1.1/24	2	Backup	Alive	
2	Yes	192.168.1.1/24	1	Master	Alive	

Figure 120 VRRP Example 2: VRRP Status on Switch B

VRRP Status						Configuration
Index	Active	Network	VRID	VR Status	Uplink Status	
1	Yes	192.168.1.10/24	2	Master	Alive	
2	Yes	192.168.1.10/24	1	Backup	Alive	

CHAPTER 32

Maintenance

This chapter explains how to configure the maintenance screens that let you maintain the firmware and configuration files.

32.1 The Maintenance Screen

Use this screen to manage firmware and your configuration files. Click **Management**, **Maintenance** in the navigation panel to open the following screen.

Figure 121 Maintenance

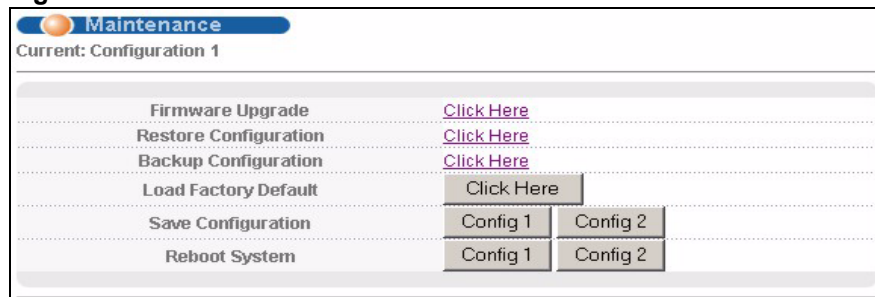

The following table describes the labels in this screen.

Table 81 Maintenance

LABEL	DESCRIPTION
Current	This field displays which configuration (Configuration 1 or Configuration 2) is currently operating on the switch.
Firmware Upgrade	Click Click Here to go to the Firmware Upgrade screen.
Restore Configuration	Click Click Here to go to the Restore Configuration screen.
Backup Configuration	Click Click Here to go to the Backup Configuration screen.
Load Factory Default	Click Click Here to reset the configuration to the factory default settings.

Table 81 Maintenance (continued)

LABEL	DESCRIPTION
Save Configuration	Click Config 1 to save the current configuration settings to Configuration 1 on the switch. Click Config 2 to save the current configuration settings to Configuration 2 on the switch.
Reboot System	Click Config 1 to reboot the system and load Configuration 1 on the switch. Click Config 2 to reboot the system and load Configuration 2 on the switch. Note: Make sure to click the Save button in any screen to save your settings to the current configuration on the switch.

32.2 Load Factory Default

Follow the steps below to reset the switch back to the factory defaults.

- 1 In the **Maintenance** screen, click the **Click Here** button next to **Load Factory Default** to clear all switch configuration information you configured and return to the factory defaults.
- 2 Click **OK** to reset all switch configurations to the factory defaults.

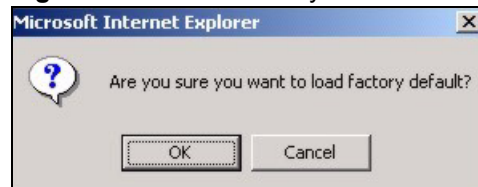
Figure 122 Load Factory Default: Start

- 3 In the web configurator, click the **Save** button to make the changes take effect. If you want to access the switch web configurator again, you may need to change the IP address of your computer to be in the same subnet as that of the default switch IP address (192.168.1.1).

32.3 Save Configuration

Click **Config 1** to save the current configuration settings permanently to **Configuration 1** on the switch.

Click **Config 2** to save the current configuration settings to **Configuration 2** on the switch.

Alternatively, click **Save** on the top right-hand corner in any screen to save the configuration changes to the current configuration.

Note: Clicking the **Apply** or **Add** button does NOT save the changes permanently. All unsaved changes are erased after you reboot the switch.

32.4 Reboot System

Reboot System allows you to restart the switch without physically turning the power off. It also allows you to load configuration one (**Config 1**) or configuration two (**Config 2**) when you reboot. Follow the steps below to reboot the switch.

- 1 In the **Maintenance** screen, click the **Config 1** button next to **Reboot System** to reboot and load configuration one. The following screen displays.

Figure 123 Reboot System: Confirmation



- 2 Click **OK** again and then wait for the switch to restart. This takes up to two minutes. This does not affect the switch's configuration.

Click **Config 2** and follow steps 1 to 2 to reboot and load configuration two on the switch.

32.5 Firmware Upgrade

Make sure you have downloaded (and unzipped) the correct model firmware and version to your computer before uploading to the device.

Note: Be sure to upload the correct model firmware as uploading the wrong model firmware may damage your device.

From the **Maintenance** screen, display the **Firmware Upgrade** screen as shown next.

Figure 124 Firmware Upgrade

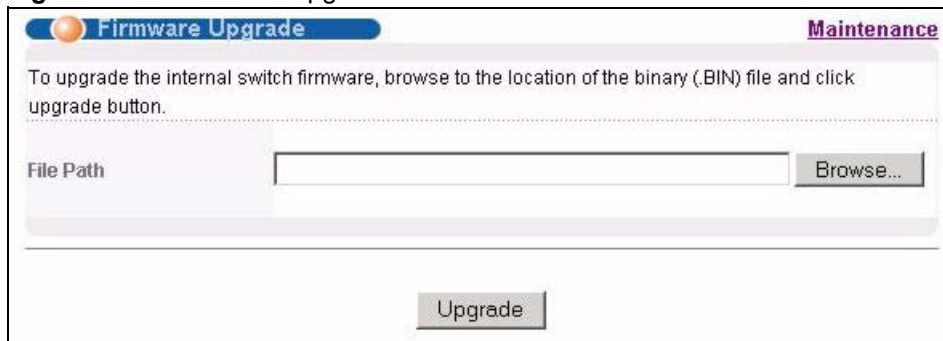

Type the path and file name of the firmware file you wish to upload to the switch in the **File Path** text box or click **Browse** to locate it. After you have specified the file, click **Upgrade**.

After the firmware upgrade process is complete, see the **System Info** screen to verify your current firmware version number.

32.6 Restore a Configuration File

Restore a previously saved configuration from your computer to the switch using the **Restore Configuration** screen.

Figure 125 Restore Configuration

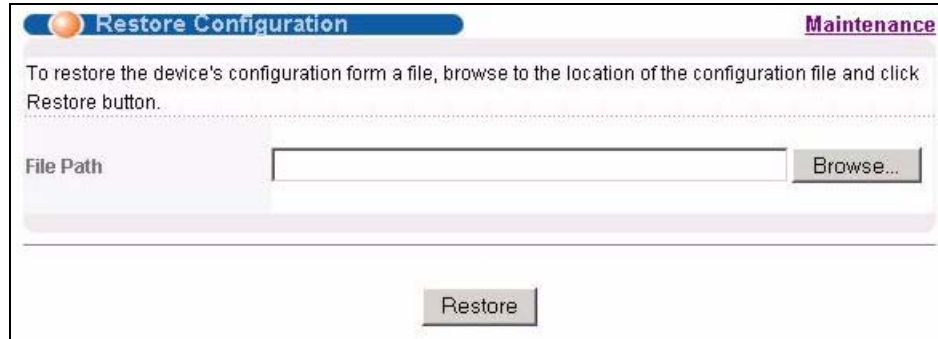

The screenshot shows a web interface for restoring a configuration file. At the top, there is a blue header with an orange circle icon, the text "Restore Configuration", and the word "Maintenance" in purple. Below the header is a light gray box containing the instruction: "To restore the device's configuration from a file, browse to the location of the configuration file and click Restore button." Below this instruction is a "File Path" label, a text input field, and a "Browse..." button. At the bottom center of the page is a "Restore" button.

Type the path and file name of the configuration file you wish to restore in the **File Path** text box or click **Browse** to display the **Choose File** screen (below) from which you can locate it. After you have specified the file, click **Restore**. "config" is the name of the configuration file on the switch, so your backup configuration file is automatically renamed when you restore using this screen.

32.7 Backup a Configuration File

Backing up your switch configurations allows you to create various “snap shots” of your device from which you may restore at a later date.

Back up your current switch configuration to a computer using the **Backup Configuration** screen.

Figure 126 Backup Configuration

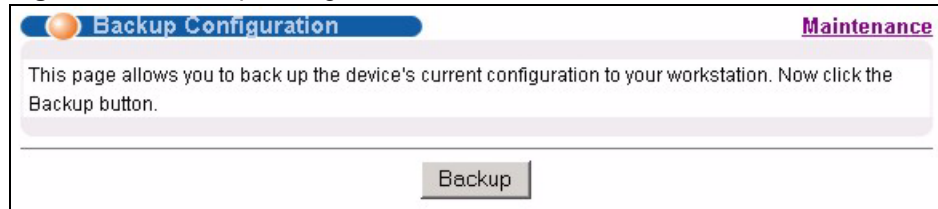

The screenshot shows a web interface for backing up the current configuration. At the top, there is a blue header with an orange circle icon, the text "Backup Configuration", and the word "Maintenance" in purple. Below the header is a light gray box containing the instruction: "This page allows you to back up the device's current configuration to your workstation. Now click the Backup button." Below this instruction is a "Backup" button.

Follow the steps below to back up the current switch configuration to your computer in this screen.

- 1 Click **Backup**.
- 2 Click **Save** to display the **Save As** screen.

- 3 Choose a location to save the file on your computer from the **Save in** drop-down list box and type a descriptive name for it in the **File name** list box. Click **Save** to save the configuration file to your computer.

32.8 FTP Command Line

This section shows some examples of uploading to or downloading files from the switch using FTP commands. First, understand the filename conventions.

32.8.1 Filename Conventions

The configuration file (also known as the romfile or ROM) contains the factory default settings in the screens such as password, switch setup, IP Setup, etc.. Once you have customized the switch's settings, they can be saved back to your computer under a filename of your choosing.

ZyNOS (ZyXEL Network Operating System sometimes referred to as the "ras" file) is the system firmware and has a "bin" filename extension.

Table 82 Filename Conventions

FILE TYPE	INTERNAL NAME	EXTERNAL NAME	DESCRIPTION
Configuration File	config		This is the configuration filename on the switch. Uploading the config file replaces the specified configuration file system, including your switch configurations, system-related data (including the default password), the error log and the trace log.
Firmware	ras	*.bin	This is the generic name for the ZyNOS firmware on the switch.

32.8.1.1 Example FTP Commands

```
ftp> put firmware.bin ras
```

This is a sample FTP session showing the transfer of the computer file "firmware.bin" to the switch.

```
ftp> get config config.cfg
```

This is a sample FTP session saving the current configuration to a file called "config.cfg" on your computer.

If your (T)FTP client does not allow you to have a destination filename different than the source, you will need to rename them as the switch only recognizes "config" and "ras". Be sure you keep unaltered copies of both files for later use.

Note: Be sure to upload the correct model firmware as uploading the wrong model firmware may damage your device.

32.8.2 FTP Command Line Procedure

- 1 Launch the FTP client on your computer.
- 2 Enter `open`, followed by a space and the IP address of your switch.
- 3 Press [ENTER] when prompted for a username.
- 4 Enter your password as requested (the default is “1234”).
- 5 Enter `bin` to set transfer mode to binary.
- 6 Use `put` to transfer files from the computer to the switch, for example, `put firmware.bin ras` transfers the firmware on your computer (`firmware.bin`) to the switch and renames it to “`ras`”. Similarly, `put config.cfg config` transfers the configuration file on your computer (`config.cfg`) to the switch and renames it to “`config`”. Likewise `get config config.cfg` transfers the configuration file on the switch to your computer and renames it to “`config.cfg`”. See [Table 82 on page 213](#) for more information on filename conventions.
- 7 Enter `quit` to exit the ftp prompt.

32.8.3 GUI-based FTP Clients

The following table describes some of the commands that you may see in GUI-based FTP clients.

General Commands for GUI-based FTP Clients

COMMAND	DESCRIPTION
Host Address	Enter the address of the host server.
Login Type	Anonymous. This is when a user I.D. and password is automatically supplied to the server for anonymous access. Anonymous logins will work only if your ISP or service administrator has enabled this option. Normal. The server requires a unique User ID and Password to login.
Transfer Type	Transfer files in either ASCII (plain text format) or in binary mode. Configuration and firmware files should be transferred in binary mode.
Initial Remote Directory	Specify the default remote directory (path).
Initial Local Directory	Specify the default local directory (path).

32.8.4 FTP Restrictions

FTP will not work when:

- FTP service is disabled in the **Service Access Control** screen.
- The IP address(es) in the **Remote Management** screen does not match the client IP address. If it does not match, the switch will disconnect the Telnet session immediately.

CHAPTER 33

Access Control

This chapter describes how to control access to the switch.

33.1 Access Control Overview

A console port and FTP are allowed one session each, Telnet and SSH share four sessions, up to five Web sessions (five different usernames and passwords) and/or limitless SNMP access control sessions are allowed.

Table 83 Access Control Overview

Console Port	SSH	Telnet	FTP	Web	SNMP
One session	Share up to four sessions		One session	Up to five accounts	No limit

A console port access control session and Telnet access control session cannot coexist when multi-login is disabled. See [Section 42.11.2 on page 261](#) for more information on disabling multi-login.

33.2 The Access Control Main Screen

Click **Management, Access Control** in the navigation panel to display the main screen as shown.

Figure 127 Access Control



33.3 About SNMP

Simple Network Management Protocol (SNMP) is an application layer protocol used to manage and monitor TCP/IP-based devices. SNMP is used to exchange management information between the network management system (NMS) and a network element (NE). A manager station can manage and monitor the switch through the network via SNMP version one (SNMPv1) and/or SNMP version 2c. The next figure illustrates an SNMP management operation. SNMP is only available if TCP/IP is configured.

Figure 128 SNMP Management Model

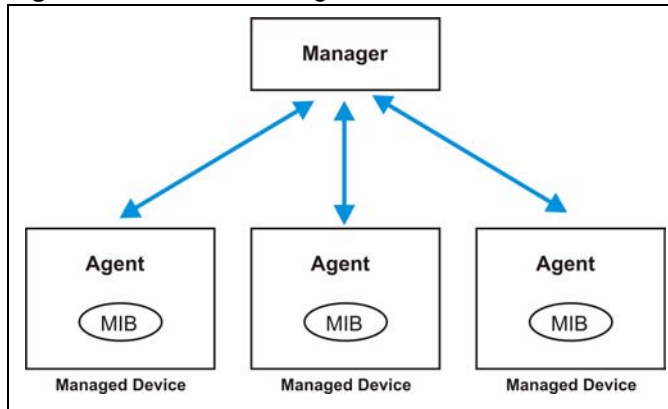

An SNMP managed network consists of two main components: agents and a manager.

An agent is a management software module that resides in a managed switch (the switch). An agent translates the local management information from the managed switch into a form compatible with SNMP. The manager is the console through which network administrators perform network management functions. It executes applications that control and monitor managed devices.

The managed devices contain object variables/managed objects that define each piece of information to be collected about a switch. Examples of variables include such as number of packets received, node port status etc. A Management Information Base (MIB) is a collection of managed objects. SNMP allows a manager and agents to communicate for the purpose of accessing these objects.

SNMP itself is a simple request/response protocol based on the manager/agent model. The manager issues a request and the agent returns responses using the following protocol operations:

Table 84 SNMP Commands

COMMAND	DESCRIPTION
Get	Allows the manager to retrieve an object variable from the agent.
GetNext	Allows the manager to retrieve the next object variable from a table or list within an agent. In SNMPv1, when a manager wants to retrieve all elements of a table from an agent, it initiates a Get operation, followed by a series of GetNext operations.

Table 84 SNMP Commands

COMMAND	DESCRIPTION
Set	Allows the manager to set values for object variables within an agent.
Trap	Used by the agent to inform the manager of some events.

33.3.1 Supported MIBs

MIBs let administrators collect statistics and monitor status and performance.

The switch supports the following MIBs:

- SNMP MIB II (RFC 1213)
- RFC 1157 SNMP v1
- RFC 1493 Bridge MIBs
- RFC 1643 Ethernet MIBs
- RFC 1155 SMI
- RFC 2674 SNMPv2, SNMPv2c
- RFC 1757 RMON
- SNMPv2, SNMPv2c or later version, compliant with RFC 2011 SNMPv2 MIB for IP, RFC 2012 SNMPv2 MIB for TCP, RFC 2013 SNMPv2 MIB for UDP

33.3.2 SNMP Traps

The switch sends traps to an SNMP manager when an event occurs. SNMP traps supported are outlined in the following table.

Table 85 SNMP Traps

OBJECT LABEL	OBJECT ID	DESCRIPTION
SNMPv2 Traps		
Cold Start	1.3.6.1.6.3.1.1.5.1	This trap is sent when the switch is turned on.
WarmStart	1.3.6.1.6.3.1.1.5.2	This trap is sent when the switch restarts.
linkDown	1.3.6.1.6.3.1.1.5.3	This trap is sent when the Ethernet link is down.
linkUp	1.3.6.1.6.3.1.1.5.4	This trap is sent when the Ethernet link is up.
authenticationFailure	1.3.6.1.6.3.1.1.5.5	This trap is sent when an SNMP request comes from non-authenticated hosts.
RFC 1493 Traps		
newRoot	1.3.6.1.2.1.17.0.1	This trap is sent when the STP topology changes.
topology change	1.3.6.1.2.1.17.0.2	This trap is sent when the STP root switch changes.

33.3.3 Configuring SNMP

From the **Access Control** screen, display the **SNMP** screen. You can click **Access Control** to go back to the **Access Control** screen.

Figure 129 Access Control: SNMP

The following table describes the labels in this screen.

Table 86 Access Control: SNMP

LABEL	DESCRIPTION
Get Community	Enter the get community, which is the password for the incoming Get- and GetNext-requests from the management station.
Set Community	Enter the set community, which is the password for incoming Set- requests from the management station.
Trap Community	Enter the trap community, which is the password sent with each trap to the SNMP manager.
Trap Destination	Enter the IP addresses of up to four stations to send your SNMP traps to.
Apply	Click Apply to save your changes to the switch's run-time memory. The switch loses these changes if it is turned off or loses power, so use the Save link on the top navigation panel to save your changes to the non-volatile memory when you are done configuring.
Cancel	Click Cancel to reset the fields.

33.3.4 Setting Up Login Accounts

Up to five people (one administrator and four non-administrators) may access the switch via web configurator at any one time.

- An administrator is someone who can both view and configure switch changes. The username for the Administrator is always **admin**. The default administrator password is **1234**.

Note: It is highly recommended that you change the default administrator password (**1234**).

- A non-administrator (username is something other than **admin**) is someone who can view but not configure switch settings.

Click **Access Control** from the navigation panel and then click **Logins** from this screen.

Figure 130 Access Control: Logins

The screenshot shows the 'Logins' configuration interface. At the top, there is a navigation bar with 'Logins' and 'Access Control' links. Below this, the 'Administrator' section contains three input fields for 'Old Password', 'New Password', and 'Retype to confirm'. A red warning message is displayed below these fields. The 'Edit Logins' section features a table with four rows and four columns: 'Login', 'User Name', 'Password', and 'Retype to confirm'. At the bottom of the page, there are 'Apply' and 'Cancel' buttons.

The following table describes the labels in this screen.

Table 87 Access Control: Logins

LABEL	DESCRIPTION
Administrator	This is the default administrator account with the "admin" user name. You cannot change the default administrator user name. Only the administrator has read/write access.
Old Password	Type the existing system password (1234 is the default password when shipped).
New Password	Enter your new system password.
Retype to confirm	Retype your new system password for confirmation
Edit Logins	You may configure passwords for up to four users. These users have read-only access. You can give users higher privileges via the CLI. For more information on assigning privileges see Chapter 42 on page 253 .
User Name	Set a user name (up to 32 ASCII characters long).
Password	Enter your new system password.
Retype to confirm	Retype your new system password for confirmation

Table 87 Access Control: Logins (continued)

LABEL	DESCRIPTION
Apply	Click Apply to save your changes to the switch's run-time memory. The switch loses these changes if it is turned off or loses power, so use the Save link on the top navigation panel to save your changes to the non-volatile memory when you are done configuring.
Cancel	Click Cancel to reset the fields.

33.4 SSH Overview

Unlike Telnet or FTP, which transmit data in clear text, SSH (Secure Shell) is a secure communication protocol that combines authentication and data encryption to provide secure encrypted communication

between two hosts over an unsecured network.

Figure 131 SSH Communication Example

33.5 How SSH works

The following table summarizes how a secure connection is established between two remote hosts.

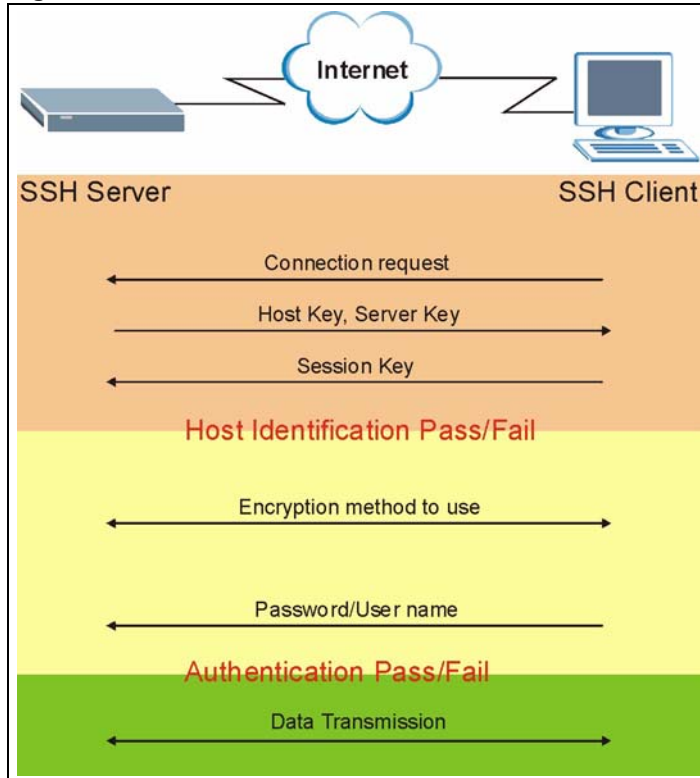
Figure 132 How SSH Works**1 Host Identification**

The SSH client sends a connection request to the SSH server. The server identifies itself with a host key. The client encrypts a randomly generated session key with the host key and server key and sends the result back to the server.

The client automatically saves any new server public keys. In subsequent connections, the server public key is checked against the saved version on the client computer.

2 Encryption Method

Once the identification is verified, both the client and server must agree on the type of encryption method to use.

3 Authentication and Data Transmission

After the identification is verified and data encryption activated, a secure tunnel is established between the client and the server. The client then sends its authentication information (user name and password) to the server to log in to the server.

33.6 SSH Implementation on the Switch

Your switch supports SSH version 2 using RSA authentication and three encryption methods (DES, 3DES and Blowfish). The SSH server is implemented on the switch for remote management and file transfer on port 22. Only one SSH connection is allowed at a time.

33.6.1 Requirements for Using SSH

You must install an SSH client program on a client computer (Windows or Linux operating system) that is used to connect to the switch over SSH.

33.7 Introduction to HTTPS

HTTPS (HyperText Transfer Protocol over Secure Socket Layer, or HTTP over SSL) is a web protocol that encrypts and decrypts web pages. Secure Socket Layer (SSL) is an application-level protocol that enables secure transactions of data by ensuring confidentiality (an unauthorized party cannot read the transferred data), authentication (one party can identify the other party) and data integrity (you know if data has been changed).

It relies upon certificates, public keys, and private keys.

HTTPS on the switch is used so that you may securely access the switch using the web configurator. The SSL protocol specifies that the SSL server (the switch) must always authenticate itself to the SSL client (the computer which requests the HTTPS connection with the switch), whereas the SSL client only should authenticate itself when the SSL server requires it to do so. Authenticating client certificates is optional and if selected means the SSL-client must send the switch a certificate. You must apply for a certificate for the browser from a CA that is a trusted CA on the switch.

Please refer to the following figure.

- 1 HTTPS connection requests from an SSL-aware web browser go to port 443 (by default) on the switch's WS (web server).
- 2 HTTP connection requests from a web browser go to port 80 (by default) on the switch's WS (web server).

Figure 133 HTTPS Implementation

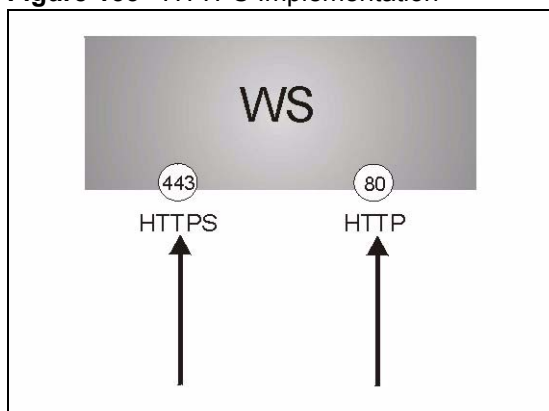

Note: If you disable **HTTP** in the **Service Access Control** screen, then the switch blocks all HTTP connection attempts.

33.8 HTTPS Example

If you haven't changed the default HTTPS port on the switch, then in your browser enter "https://switch IP Address/" as the web site address where "switch IP Address" is the IP address or domain name of the switch you wish to access.

33.8.1 Internet Explorer Warning Messages

When you attempt to access the switch HTTPS server, a Windows dialog box pops up asking if you trust the server certificate. Click **View Certificate** if you want to verify that the certificate is from the switch.

You see the following **Security Alert** screen in Internet Explorer. Select **Yes** to proceed to the web configurator login screen; if you select **No**, then web configurator access is blocked.

Figure 134 Security Alert Dialog Box (Internet Explorer)



33.8.2 Netscape Navigator Warning Messages

When you attempt to access the switch HTTPS server, a **Website Certified by an Unknown Authority** screen pops up asking if you trust the server certificate. Click **Examine Certificate** if you want to verify that the certificate is from the switch.

If **Accept this certificate temporarily for this session** is selected, then click **OK** to continue in Netscape.

Select **Accept this certificate permanently** to import the switch's certificate into the SSL client.

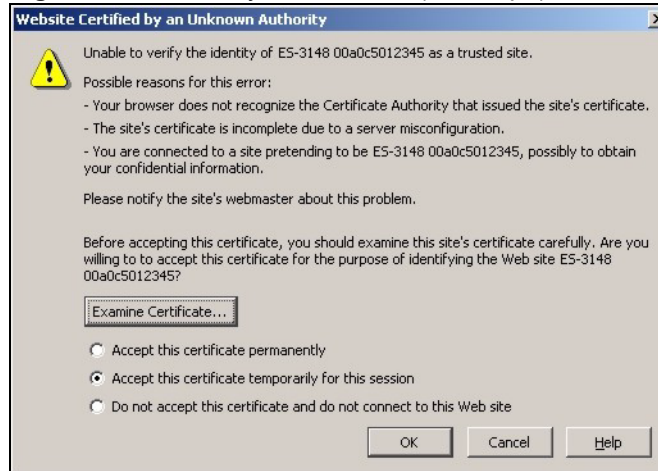
Figure 135 Security Certificate 1 (Netscape)**Figure 136 Security Certificate 2 (Netscape)**

33.8.3 The Main Screen

After you accept the certificate and enter the login username and password, the switch main screen appears. The lock displayed in the bottom right of the browser status bar denotes a secure connection.

Figure 137 Example: Lock Denoting a Secure Connection

The screenshot shows the ZyXEL Web Configurator interface in Microsoft Internet Explorer. The browser's address bar shows the URL `http://192.168.0.1/rpSys.html`. The page title is "Port Status" and the system up time is 0:53:43. The interface includes a navigation menu on the left with options like "Basic Setting", "Advanced Application", "IP Application", and "Management". The main content area displays a table of port status information.

Port	Link	State	LACP	TxPkts	RxPkts	Errors	Tx KB/s	Rx KB/s	Up Time
1	Down	STOP	Disabled	0	0	0	0.0	0.0	0:00:00
2	Down	STOP	Disabled	0	0	0	0.0	0.0	0:00:00
3	Down	STOP	Disabled	0	0	0	0.0	0.0	0:00:00
4	Down	STOP	Disabled	0	0	0	0.0	0.0	0:00:00
5	Down	STOP	Disabled	0	0	0	0.0	0.0	0:00:00
6	Down	STOP	Disabled	0	0	0	0.0	0.0	0:00:00
7	Down	STOP	Disabled	0	0	0	0.0	0.0	0:00:00
8	Down	STOP	Disabled	0	0	0	0.0	0.0	0:00:00
9	Down	STOP	Disabled	0	0	0	0.0	0.0	0:00:00
10	Down	STOP	Disabled	0	0	0	0.0	0.0	0:00:00
11	Down	STOP	Disabled	0	0	0	0.0	0.0	0:00:00
12	Down	STOP	Disabled	0	0	0	0.0	0.0	0:00:00
13	Down	STOP	Disabled	0	0	0	0.0	0.0	0:00:00
14	Down	STOP	Disabled	0	0	0	0.0	0.0	0:00:00
15	Down	STOP	Disabled	0	0	0	0.0	0.0	0:00:00
16	Down	STOP	Disabled	0	0	0	0.0	0.0	0:00:00

At the bottom of the page, there is a "Port" dropdown menu set to "ALL" and a "Clear Counter" button. The browser's status bar shows a lock icon, indicating a secure connection, which is circled in red in the original image.

33.9 Service Port Access Control

Service Access Control allows you to decide what services you may use to access the switch. You may also change the default service port and configure “trusted computer(s)” for each service in the **Remote Management** screen (discussed later). Click **Access Control** to go back to the main **Access Control** screen.

Figure 138 Access Control: Service Access Control

Services	Active	Service Port	Timeout
Telnet	<input checked="" type="checkbox"/>	23	
SSH	<input checked="" type="checkbox"/>	22	
FTP	<input checked="" type="checkbox"/>	21	
HTTP	<input checked="" type="checkbox"/>	80	3 Minutes
HTTPS	<input checked="" type="checkbox"/>	443	
ICMP	<input checked="" type="checkbox"/>		
SNMP	<input checked="" type="checkbox"/>		

The following table describes the fields in this screen.

Table 88 Access Control: Service Access Control

LABEL	DESCRIPTION
Services	Services you may use to access the switch are listed here.
Active	Select this option for the corresponding services that you want to allow to access the switch.
Service Port	For Telnet, SSH, FTP, HTTP or HTTPS services, you may change the default service port by typing the new port number in the Server Port field. If you change the default port number then you will have to let people (who wish to use the service) know the new port number for that service.
Timeout	Type how many minutes a management session (via the web configurator) can be left idle before the session times out. After it times out you have to log in with your password again. Very long idle timeouts may have security risks.
Apply	Click Apply to save your changes to the switch's run-time memory. The switch loses these changes if it is turned off or loses power, so use the Save link on the top navigation panel to save your changes to the non-volatile memory when you are done configuring.
Cancel	Click Cancel to reset the fields.

33.10 Remote Management

From the **Access Control** screen, display the **Remote Management** screen as shown next.

You can specify a group of one or more “trusted computers” from which an administrator may use a service to manage the switch. Click **Access Control** to return to the **Access Control** screen.

Figure 139 Access Control: Remote Management

Entry	Active	Start Address	End Address	Telnet	FTP	HTTP	ICMP	SNMP	SSH	HTTPS
1	<input checked="" type="checkbox"/>	0.0.0.0	0.0.0.0	<input checked="" type="checkbox"/>	<input checked="" type="checkbox"/>	<input checked="" type="checkbox"/>	<input checked="" type="checkbox"/>	<input checked="" type="checkbox"/>	<input checked="" type="checkbox"/>	<input checked="" type="checkbox"/>
2	<input type="checkbox"/>	0.0.0.0	0.0.0.0	<input type="checkbox"/>	<input type="checkbox"/>	<input type="checkbox"/>	<input type="checkbox"/>	<input type="checkbox"/>	<input type="checkbox"/>	<input type="checkbox"/>
3	<input type="checkbox"/>	0.0.0.0	0.0.0.0	<input type="checkbox"/>	<input type="checkbox"/>	<input type="checkbox"/>	<input type="checkbox"/>	<input type="checkbox"/>	<input type="checkbox"/>	<input type="checkbox"/>
4	<input type="checkbox"/>	0.0.0.0	0.0.0.0	<input type="checkbox"/>	<input type="checkbox"/>	<input type="checkbox"/>	<input type="checkbox"/>	<input type="checkbox"/>	<input type="checkbox"/>	<input type="checkbox"/>

Apply Cancel

The following table describes the labels in this screen.

Table 89 Access Control: Remote Management

LABEL	DESCRIPTION
Entry	This is the client set index number. A “client set” is a group of one or more “trusted computers” from which an administrator may use a service to manage the switch.
Active	Select this check box to activate this secured client set. Clear the check box if you wish to temporarily disable the set without deleting it.
Start Address End Address	Configure the IP address range of trusted computers from which you can manage this switch. The switch checks if the client IP address of a computer requesting a service or protocol matches the range set here. The switch immediately disconnects the session if it does not match.
Telnet/FTP/ HTTP/ICMP/ SNMP/SSH/ HTTPS	Select services that may be used for managing the switch from the specified trusted computers.
Apply	Click Apply to save your changes to the switch’s run-time memory. The switch loses these changes if it is turned off or loses power, so use the Save link on the top navigation panel to save your changes to the non-volatile memory when you are done configuring.
Cancel	Click Cancel to reset the fields.

CHAPTER 34

Diagnostic

This chapter explains the **Diagnostic** screen.

34.1 Diagnostic

Click **Management, Diagnostic** in the navigation panel to open this screen. Use this screen to check system logs, ping IP addresses or perform port tests.

Figure 140 Diagnostic

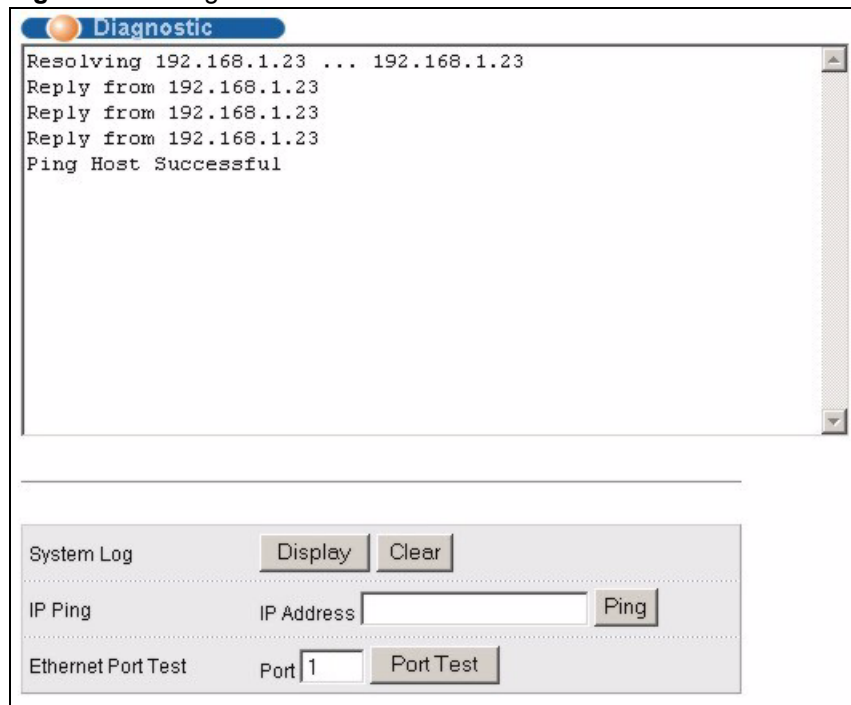

The following table describes the labels in this screen.

Table 90 Diagnostic

LABEL	DESCRIPTION
System Log	Click Display to display a log of events in the multi-line text box. Click Clear to empty the text box and reset the syslog entry.
IP Ping	Type the IP address of a device that you want to ping in order to test a connection. Click Ping to have the switch ping the IP address (in the field to the left).
Ethernet Port Test	Enter a port number and click Port Test to perform an internal loopback test.

CHAPTER 35

Syslog

This chapter explains the syslog screens.

35.1 Syslog Overview

The syslog protocol allows devices to send event notification messages across an IP network to syslog servers that collect the event messages. A syslog-enabled device can generate a syslog message and send it to a syslog server.

Syslog is defined in RFC 3164. The RFC defines the packet format, content and system log related information of syslog messages. Each syslog message has a facility and severity level. The syslog facility identifies a file in the syslog server. Refer to the documentation of your syslog program for details. The following table describes the syslog severity levels.

Table 91 Syslog Severity Levels

CODE	SEVERITY
0	Emergency: The system is unusable.
1	Alert: Action must be taken immediately.
2	Critical: The system condition is critical.
3	Error: There is an error condition on the system.
4	Warning: There is a warning condition on the system.
5	Notice: There is a normal but significant condition on the system.
6	Informational: The syslog contains an informational message.
7	Debug: The message is intended for debug-level purposes.

35.2 Syslog Setup

Click **Management** and then **Syslog** in the navigation panel to display this screen. The syslog feature sends logs to an external syslog server. Use this screen to configure the device's system logging settings.

Figure 141 Syslog

Logging type	Active	Facility
System	<input type="checkbox"/>	local use 0
Interface	<input type="checkbox"/>	local use 0
Switch	<input type="checkbox"/>	local use 0
Authentication	<input type="checkbox"/>	local use 0
IP	<input type="checkbox"/>	local use 0

The following table describes the labels in this screen.

Table 92 Syslog

LABEL	DESCRIPTION
Syslog	Select Active to turn on syslog (system logging) and then configure the syslog setting
Logging Type	This column displays the names of the categories of logs that the device can generate.
Active	Select this option to set the device to generate logs for the corresponding category.
Facility	The log facility allows you to send logs to different files in the syslog server. Refer to the documentation of your syslog program for more details.
Apply	Click Apply to save your changes to the switch's run-time memory. The switch loses these changes if it is turned off or loses power, so use the Save link on the top navigation panel to save your changes to the non-volatile memory when you are done configuring.
Cancel	Click Cancel to reset the fields.

35.3 Syslog Server Setup

Click **Management** and then **Syslog** in the navigation panel to display the **Syslog Setup** screen. Click the **Syslog Server Setup** link to open the following screen. Use this screen to configure a list of external syslog servers.

Figure 142 Syslog: Server Setup

The following table describes the labels in this screen.

Table 93 Syslog: Server Setup

LABEL	DESCRIPTION
Active	Select this check box to have the device send logs to this syslog server. Clear the check box if you want to create a syslog server entry but not have the device send logs to it (you can edit the entry later).
Server Address	Enter the IP address of the syslog server.
Log Level	Select the severity level(s) of the logs that you want the device to send to this syslog server. The lower the number, the more critical the logs are.
Add	Click Add to save your changes to the switch's run-time memory. The switch loses these changes if it is turned off or loses power, so use the Save link on the top navigation panel to save your changes to the non-volatile memory when you are done configuring.
Cancel	Click Cancel to reset the fields.
Clear	Click Clear to return the fields to the factory defaults.
Index	This is the index number of a syslog server entry. Click this number to edit the entry.
Active	This field displays Yes if the device is to send logs to the syslog server. No displays if the device is not to send logs to the syslog server.
IP Address	This field displays the IP address of the syslog server.
Log Level	This field displays the severity level of the logs that the device is to send to this syslog server.
Delete	Select an entry's Delete check box and click Delete to remove the entry.
Cancel	Click Cancel to reset the fields.

CHAPTER 36

Cluster Management

This chapter introduces cluster management.

36.1 Cluster Management Status Overview

Cluster Management allows you to manage switches through one switch, called the cluster manager. The switches must be directly connected and be in the same VLAN group so as to be able to communicate with one another.

Table 94 ZyXEL Clustering Management Specifications

Maximum number of cluster members	24
Cluster Member Models	Must be compatible with ZyXEL cluster management implementation.
Cluster Manager	The switch through which you manage the cluster member switches.
Cluster Members	The switches being managed by the cluster manager switch.

In the following example, switch **A** in the basement is the cluster manager and the other switches on the upper floors of the building are cluster members.

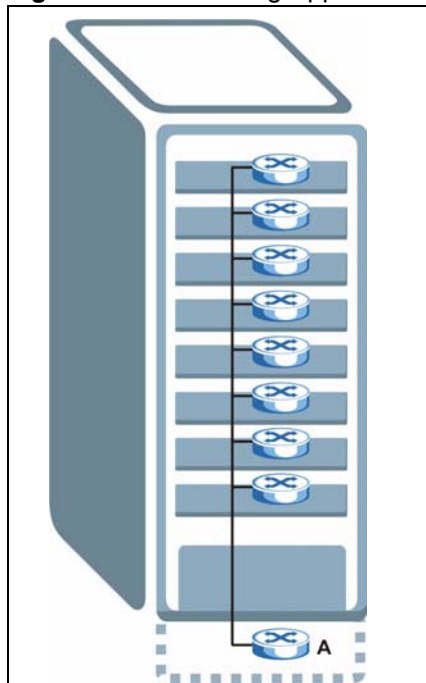
Figure 143 Clustering Application Example

36.2 Cluster Management Status

Click **Management**, **Cluster Management** in the navigation panel to display the following screen.

Note: A cluster can only have one manager.

Figure 144 Cluster Management: Status

Clustering Management Status		Configuration		
Status	Manager			
Manager	00:13:49:00:00:02			
The Number Of Member = 1				
Index	MacAddr	Name	Model	Status
1	00:a0:c5:01:23:46		GS-2024	Online

The following table describes the labels in this screen.

Table 95 Cluster Management: Status

LABEL	DESCRIPTION
Status	This field displays the role of this switch within the cluster. Manager Member (you see this if you access this screen in the cluster member switch directly and not via the cluster manager) None (neither a manager nor a member of a cluster)
Manager	This field displays the cluster manager switch's hardware MAC address.
The Number of Member	This field displays the number of switches that make up this cluster. The following fields describe the cluster member switches.
Index	You can manage cluster member switches via the cluster manager switch. Each number in the Index column is a hyperlink leading to the cluster member switch's web configurator (see Figure 145 on page 238).
MacAddr	This is the cluster member switch's hardware MAC address.
Name	This is the cluster member switch's System Name .
Model	This field displays the model name.
Status	This field displays: Online (the cluster member switch is accessible) Error (for example the cluster member switch password was changed or the switch was set as the manager and so left the member list, etc.) Offline (the switch is disconnected - Offline shows approximately 1.5 minutes after the link between cluster member and manager goes down)

36.2.1 Cluster Member Switch Management

Go to the **Clustering Management Status** screen of the cluster manager switch and then select an **Index** hyperlink from the list of members to go to that cluster member switch's web configurator home page. This cluster member web configurator home page and the home page that you'd see if you accessed it directly are different.

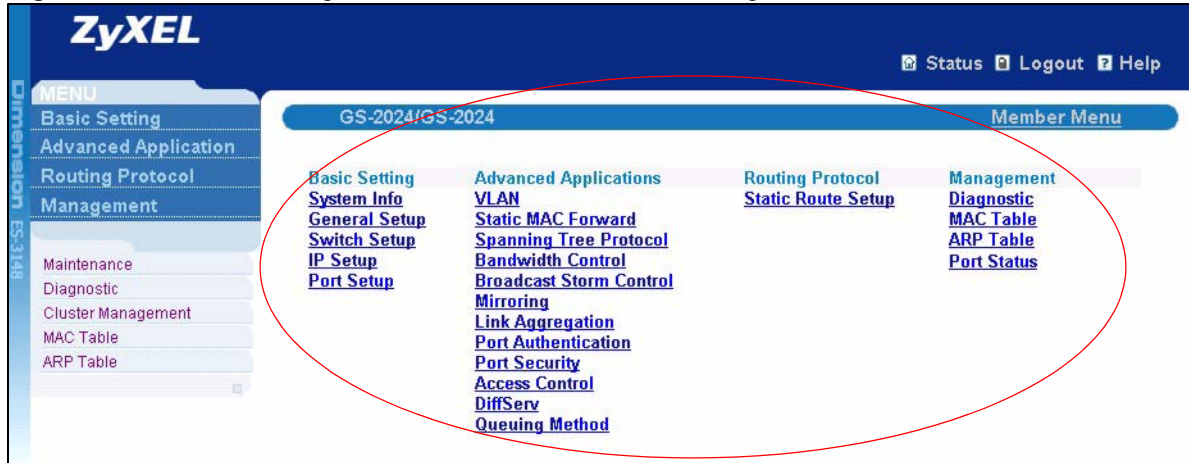
Figure 145 Cluster Management: Cluster Member Web Configurator Screen

36.2.1.1 Uploading Firmware to a Cluster Member Switch

You can use FTP to upload firmware to a cluster member switch through the cluster manager switch as shown in the following example.

Figure 146 Example: Uploading Firmware to a Cluster Member Switch

```

C:\>ftp 192.168.1.1
Connected to 192.168.1.1.
220 switch FTP version 1.0 ready at Thu Jan  1 00:58:46 1970
User (192.168.0.1:(none)): admin
331 Enter PASS command
Password:
230 Logged in
ftp> ls
200 Port command okay
150 Opening data connection for LIST
--w--w--w-  1 owner   group           3042210 Jul  01 12:00 ras
-rw-rw-rw-  1 owner   group           393216  Jul  01 12:00 config
--w--w--w-  1 owner   group              0 Jul  01 12:00 fw-00-a0-c5-01-23-46
-rw-rw-rw-  1 owner   group              0 Jul  01 12:00 config-00-a0-c5-01-23-46
226 File sent OK
ftp: 297 bytes received in 0.00Seconds 297000.00Kbytes/sec.
ftp> bin
200 Type I OK
ftp> put 3701t0.bin fw-00-a0-c5-01-23-46
200 Port command okay
150 Opening data connection for STOR fw-00-a0-c5-01-23-46
226 File received OK
ftp: 262144 bytes sent in 0.63Seconds 415.44Kbytes/sec.
ftp>

```

The following table explains some of the FTP parameters.

Table 96 FTP Upload to Cluster Member Example

FTP PARAMETER	DESCRIPTION
User	Enter "admin".
Password	The web configurator password default is 1234.
ls	Enter this command to list the name of cluster member switch's firmware and configuration file.
3601t0.bin	This is the name of the firmware file you want to upload to the cluster member switch.
fw-00-a0-c5-01-23-46	This is the cluster member switch's firmware name as seen in the cluster manager switch.
config-00-a0-c5-01-23-46	This is the cluster member switch's configuration file name as seen in the cluster manager switch.

36.3 Clustering Management Configuration

Use this screen to configure clustering management. Click **Configuration** from the **Cluster Management** screen to display the next screen.

Figure 147 Clustering Management Configuration

Clustering Management Configuration [Status](#)

Clustering Manager:

Active

Name

VID

Apply Cancel

Clustering Candidate:

List

Password

Add Cancel Refresh

Index	MacAddr	Name	Model	Remove
Remove Cancel				

The following table describes the labels in this screen.

Table 97 Clustering Management Configuration



LABEL	DESCRIPTION
Clustering Manager	
Active	Select Active to have this switch become the cluster manager switch. A cluster can only have one manager. Other (directly connected) switches that are set to be cluster managers will not be visible in the Clustering Candidates list. If a switch that was previously a cluster member is later set to become a cluster manager, then its Status is displayed as Error in the Cluster Management Status screen and a warning icon () appears in the member summary list below.
Name	Type a name to identify the Clustering Manager . You may use up to 32 printable characters (spaces are allowed).
VID	This is the VLAN ID and is only applicable if the switch is set to 802.1Q VLAN. All switches must be directly connected and in the same VLAN group to belong to the same cluster. Switches that are not in the same VLAN group are not visible in the Clustering Candidates list. This field is ignored if the Clustering Manager is using Port-based VLAN.

Table 97 Clustering Management Configuration (continued)

LABEL	DESCRIPTION
Apply	Click Apply to save your changes to the switch's run-time memory. The switch loses these changes if it is turned off or loses power, so use the Save link on the top navigation panel to save your changes to the non-volatile memory when you are done configuring.
Cancel	Click Cancel to reset the fields.
Clustering Candidate	The following fields relate to the switches that are potential cluster members.
List	A list of suitable candidates found by auto-discovery is shown here. The switches must be directly connected. Directly connected switches that are set to be cluster managers will not be visible in the Clustering Candidate list. Switches that are not in the same management VLAN group will not be visible in the Clustering Candidate list.
Password	Each cluster member's password is its web configurator password. Select a member in the Clustering Candidate list and then enter its web configurator password. If that switch administrator changes the web configurator password afterwards, then it cannot be managed from the Cluster Manager . Its Status is displayed as Error in the Cluster Management Status screen and a warning icon () appears in the member summary list below. If multiple devices have the same password then hold [SHIFT] and click those switches to select them. Then enter their common web configurator password.
Add	Click Add to save your changes to the switch's run-time memory. The switch loses these changes if it is turned off or loses power, so use the Save link on the top navigation panel to save your changes to the non-volatile memory when you are done configuring.
Cancel	Click Cancel to reset the fields.
Refresh	Click Refresh to perform auto-discovery again to list potential cluster members.
The next summary table shows the information for the clustering members configured.	
Index	This is the index number of a cluster member switch.
MacAddr	This is the cluster member switch's hardware MAC address.
Name	This is the cluster member switch's System Name .
Model	This is the cluster member switch's model name.
Remove	Select this checkbox and then click the Remove button to remove a cluster member switch from the cluster.
Cancel	Click Cancel to reset the fields.

CHAPTER 37

MAC Table

This chapter introduces the **MAC Table** screen.

37.1 MAC Table Overview

The **MAC Table** screen (a MAC table is also known as a filtering database) shows how frames are forwarded or filtered across the switch's ports. It shows what device MAC address, belonging to what VLAN group (if any) is forwarded to which port(s) and whether the MAC address is dynamic (learned by the switch) or static (manually entered in the **Static MAC Forwarding** screen).

The switch uses the MAC table to determine how to forward frames. See the following figure.

- 1 The switch examines a received frame and learns the port on which this source MAC address came.
- 2 The switch checks to see if the frame's destination MAC address matches a source MAC address already learned in the MAC table.
 - If the switch has already learned the port for this MAC address, then it forwards the frame to that port.
 - If the switch has not already learned the port for this MAC address, then the frame is flooded to all ports. Too much port flooding leads to network congestion.
 - If the switch has already learned the port for this MAC address, but the destination port is the same as the port it came in on, then it filters the frame.

Figure 148 MAC Table Flowchart

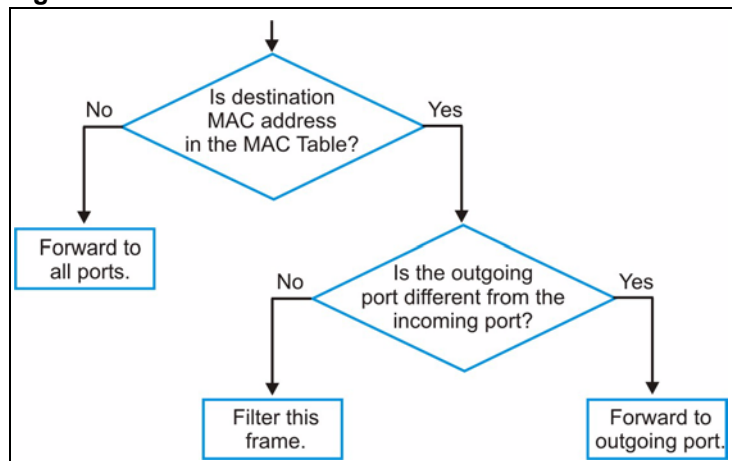

37.2 Viewing the MAC Table

Click **Management**, **MAC Table** in the navigation panel to display the following screen.

Figure 149 MAC Table

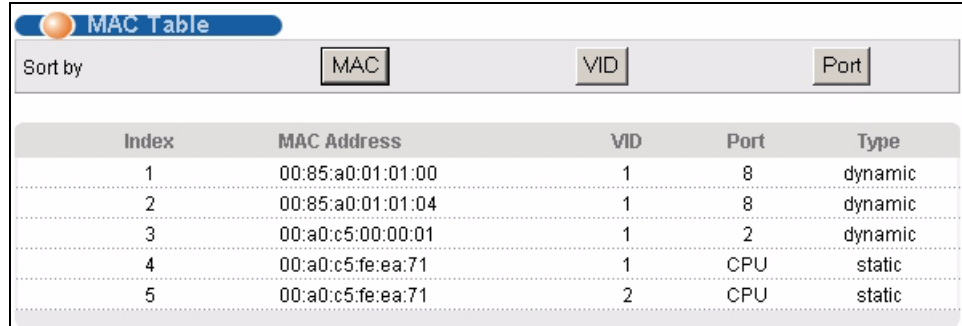

MAC Table				
Sort by	MAC	VID	Port	
Index	MAC Address	VID	Port	Type
1	00:85:a0:01:01:00	1	8	dynamic
2	00:85:a0:01:01:04	1	8	dynamic
3	00:a0:c5:00:00:01	1	2	dynamic
4	00:a0:c5:fe:ea:71	1	CPU	static
5	00:a0:c5:fe:ea:71	2	CPU	static

The following table describes the labels in this screen.

Table 98 MAC Table

LABEL	DESCRIPTION
Sort by	Click one of the following buttons to display and arrange the data according to that button type. The information is then displayed in the summary table below.
MAC	Click this button to display and arrange the data according to MAC address.
VID	Click this button to display and arrange the data according to VLAN group.
Port	Click this button to display and arrange the data according to port number.
Index	This is the incoming frame index number.
MAC Address	This is the MAC address of the device from which this incoming frame came.
VID	This is the VLAN group to which this frame belongs.
Port	This is the port from which the above MAC address was learned.
Type	This shows whether the MAC address is dynamic (learned by the switch) or static (manually entered in the Static MAC Forwarding screen).

CHAPTER 38

IP Table

This chapter introduces the IP table.

38.1 IP Table Overview

The **IP Table** screen shows how packets are forwarded or filtered across the switch's ports. It shows what device IP address, belonging to what VLAN group (if any) is forwarded to which port(s) and whether the IP address is dynamic (learned by the switch) or static (belonging to the switch).

The switch uses the IP table to determine how to forward packets. See the following figure.

- 1 The switch examines a received packet and learns the port on which this source IP address came.
- 2 The switch checks to see if the packet's destination IP address matches a source IP address already learned in the IP table.
 - If the switch has already learned the port for this IP address, then it forwards the packet to that port.
 - If the switch has not already learned the port for this IP address, then the packet is flooded to all ports. Too much port flooding leads to network congestion.
 - If the switch has already learned the port for this IP address, but the destination port is the same as the port it came in on, then it filters the packet.

Figure 150 IP Table Flowchart

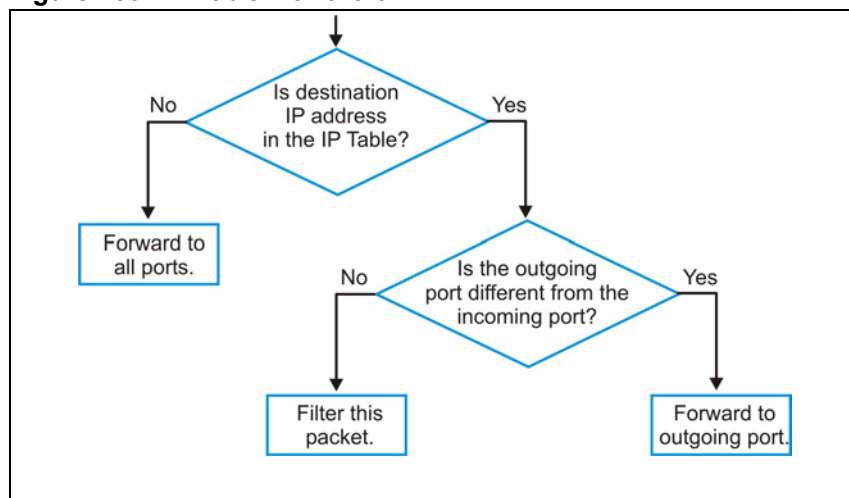

38.2 Viewing the IP Table

Click **Management, IP Table** in the navigation panel to display the following screen.

Figure 151 IP Table

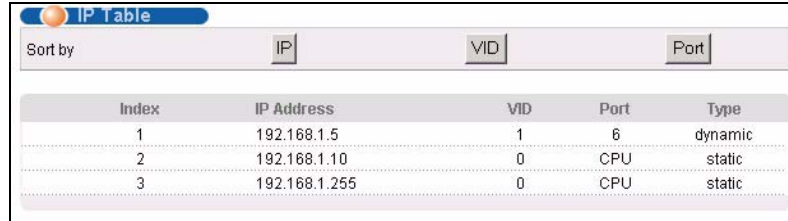

Index	IP Address	VID	Port	Type
1	192.168.1.5	1	6	dynamic
2	192.168.1.10	0	CPU	static
3	192.168.1.255	0	CPU	static

The following table describes the labels in this screen.

Table 99 IP Table

LABEL	DESCRIPTION
Sort by	Click one of the following buttons to display and arrange the data according to that button type. The information is then displayed in the summary table below.
IP	Click this button to display and arrange the data according to IP address.
VID	Click this button to display and arrange the data according to VLAN group.
Port	Click this button to display and arrange the data according to port number.
Index	This field displays the index number.
IP Address	This is the IP address of the device from which the incoming packets came.
VID	This is the VLAN group to which the packet belongs.
Port	This is the port from which the above IP address was learned. This field displays CPU to indicate the IP address belongs to the switch.
Type	This shows whether the IP address is dynamic (learned by the switch) or static (belonging to the switch).

CHAPTER 39

ARP Table

This chapter introduces ARP Table.

39.1 ARP Table Overview

Address Resolution Protocol (ARP) is a protocol for mapping an Internet Protocol address (IP address) to a physical machine address, also known as a Media Access Control or MAC address, on the local area network.

An IP (version 4) address is 32 bits long. In an Ethernet LAN, MAC addresses are 48 bits long. The ARP Table maintains an association between each MAC address and its corresponding IP address.

39.1.1 How ARP Works

When an incoming packet destined for a host device on a local area network arrives at the switch, the switch's ARP program looks in the ARP Table and, if it finds the address, sends it to the device.

If no entry is found for the IP address, ARP broadcasts the request to all the devices on the LAN. The switch fills in its own MAC and IP address in the sender address fields, and puts the known IP address of the target in the target IP address field. In addition, the switch puts all ones in the target MAC field (FF.FF.FF.FF.FF.FF is the Ethernet broadcast address). The replying device (which is either the IP address of the device being sought or the router that knows the way) replaces the broadcast address with the target's MAC address, swaps the sender and target pairs, and unicasts the answer directly back to the requesting machine. ARP updates the ARP Table for future reference and then sends the packet to the MAC address that replied.

39.2 Viewing the ARP Table

Click **Management, ARP Table** in the navigation panel to open the following screen. Use the ARP table to view IP-to-MAC address mapping(s).

Figure 152 ARP Table

ARP Table			
Index	IP Address	MAC Address	Type
1	172.21.0.2	00:05:5d:04:30:f1	dynamic
2	172.21.3.16	00:05:1c:15:08:71	dynamic
3	172.21.3.19	00:0b:cd:8c:6d:ed	dynamic
4	172.21.3.40	00:0c:76:07:41:0d	dynamic
5	172.21.3.66	00:50:8d:47:73:4f	dynamic
6	172.21.3.90	00:05:5d:f4:49:20	dynamic
7	172.21.3.91	00:50:ba:ad:56:7c	dynamic
8	172.21.3.95	00:10:b5:ae:56:97	dynamic
9	172.21.3.120	00:10:b5:ae:62:32	dynamic
10	172.21.3.138	00:a0:c5:b2:62:26	dynamic
11	172.21.4.99	00:0c:76:09:cf:88	dynamic
12	172.21.10.11	08:00:20:ad:f6:88	dynamic
13	172.21.100.153	00:90:27:be:a2:8c	dynamic
14	172.21.207.247	00:0c:76:09:17:1a	dynamic
15	192.168.1.1	00:a0:c5:3f:91:56	dynamic
16	192.168.1.5	00:85:a0:01:01:04	dynamic
17	192.168.1.10	00:a0:c5:5e:df:f9	static
18	192.168.1.100	00:85:a0:01:01:00	dynamic

The following table describes the labels in this screen.

Table 100 ARP Table

LABEL	DESCRIPTION
Index	This is the ARP Table entry number.
IP Address	This is the learned IP address of a device connected to a switch port with corresponding MAC address below.
MAC Address	This is the MAC address of the device with corresponding IP address above.
Type	This shows whether the MAC address is dynamic (learned by the switch) or static (manually entered in the Static MAC Forwarding screen).

CHAPTER 40

Routing Table

This chapter introduces the routing table.

40.1 Overview

The routing table contains the route information to the network(s) that the switch can reach. The switch automatically updates the routing table with the RIP information received from other Ethernet devices.

40.2 Viewing the Routing Table

Use this screen to view routing table information. Click **Management, Routing Table** in the navigation panel to display the screen as shown.

Figure 153 Routing Table Status

Routing Table Status					
Index	Destination	Gateway	Interface	Metric	Type
1	192.168.1.0/24	192.168.1.1	192.168.1.1	1	STATIC
2	10.10.10.0/24	10.10.10.1	10.10.10.1	1	STATIC

The following table describes the labels in this screen.

Table 101 Routing Table Status

LABEL	DESCRIPTION
Index	This field displays the index number.
Destination	This field displays the destination IP routing domain.
Gateway	This field displays the IP address of the gateway device.
Interface	This field displays the IP address of the Interface.
Metric	This field displays the cost of the route.
Type	This field displays the method used to learn the route.

CHAPTER 41

Configure Clone

This chapter shows you how you can copy the settings of one port onto other ports.

41.1 Configure Clone

Cloning allows you to copy the basic and advanced settings from a source port to a destination port or ports. Click **Management, Configure Clone** to open the following screen.

Figure 154 Configure Clone

The following table describes the labels in this screen.

Table 102 Configure Clone

LABEL	DESCRIPTION
Source/ Destination Port	Enter the source port under the Source label. This port's attributes are copied. Enter the destination port or ports under the Destination label. These are the ports which are going to have the same attributes as the source port. You can enter individual ports separated by a comma or a range of ports by using a dash. Example: <ul style="list-style-type: none"> • 2, 4, 6 indicates that ports 2, 4 and 6 are the destination ports. • 2-6 indicates that ports 2 through 6 are the destination ports.
Basic Setting	Select which port settings (you configured in the Basic Setting menus) should be copied to the destination port(s).

Table 102 Configure Clone (continued)

LABEL	DESCRIPTION
Advanced Application	Select which port settings (you configured in the Advanced Application menus) should be copied to the destination ports.
Apply	Click Apply to save your changes to the switch's run-time memory. The switch loses these changes if it is turned off or loses power, so use the Save link on the top navigation panel to save your changes to the non-volatile memory when you are done configuring.
Cancel	Click Cancel to reset the fields.

CHAPTER 42

Introducing Commands

This chapter introduces commands and gives a summary of commands available.

42.1 Overview

In addition to the web configurator, you can use commands to configure the switch. Use commands for advanced switch diagnosis and troubleshooting. If you have problems with your switch, customer support may request that you issue some of these commands to assist them in troubleshooting.

Note: See the web configurator parts of this User's Guide for background information on features configurable by the web configurator.

42.2 Accessing the CLI

You can use a direct console connection or Telnet to access the command interpreter on the switch.

Note: The switch automatically logs you out of the management interface after five minutes of inactivity. If this happens to you, simply log back in again.

- By default, multiple command interpreter management sessions are allowed via either the console port or Telnet. However, no more than five concurrent login sessions are allowed.
- Use the `configure multi-login` command in the configuration mode to limit concurrent logins to one. Console port access has higher priority.

42.2.1 The Console Port

Connect to the switch's console port using a terminal emulation software configured to the following settings:

- VT100 terminal emulation
- 9600 bps
- No parity
- 8 data bits
- 1 stop bit
- No flow control

42.2.1.1 Initial Screen

When you turn on your switch, it performs several internal tests as well as line initialization. You can view the initialization information using the console port. After the initialization, the login screen displays (refer to [Section 42.3 on page 254](#)).

```
Copyright (c) 1994 - 2006 ZyXEL Communications Corp.
initialize mgmt, ethernet address: 00:13:49:00:00:01
initialize switch, ethernet address: 00:13:49:00:00:02
Initializing switch unit 0...
Initializing VLAN Database...
Initializing IP Interface...
Initializing Advanced Applications...
Initializing Command Line Interface...
Initializing Web Interface...
Press ENTER to continue...
```

Use the following steps to telnet into your switch.

- 1 For local management, connect your computer to the RJ-45 management port (labeled **MGMT**) on the switch.
- 2 Make sure your computer IP address and the switch IP address are on the same subnet. In Windows, click **Start** (usually in the bottom left corner), **Run** and then type `telnet 192.168.0.1` (the default management IP address) and click **OK**.
- 3 A login screen displays (refer to [Section 42.3 on page 254](#)).

42.3 The Login Screen

After you have successfully established a connection to the switch using a direct console connection or Telnet, a login screen displays as shown below. For your first login, enter the default administrator login username “admin” and password “1234”.

```
Enter User Name : admin
Enter Password : XXXX
```

42.4 Command Syntax Conventions

The rules of the commands are listed next.

- The command keywords are in *courier new font*.
- The required fields in a command are enclosed in angle brackets `<>`, for instance, `ping <ip>` means that you must specify an IP number for this command.
- The optional fields in a command are enclosed in square brackets `[]`, for instance, `configure snmp-server [contact <system contact>] [location <system location>]`

means that the contact and location fields are optional.

- “Command” refers to a command used in the command line interface (CLI command).
- The | symbol means “or”.
- The entry <cr> in the command lines refers to carriage return. Press [ENTER] or carriage return after a command to execute the command.
- Use the up or down arrow key to scroll through the command history list.
- You may enter a unique part of a command and press [TAB] to have the switch automatically display the full command. For example, if you enter “config” and press [TAB], the full command of “configure” automatically displays.
- Each interface refers to an Ethernet port on the switch. Commands configured after the interface command correspond to those ports.
- Type multiple ports or port ranges separated by a comma. Ranges of port numbers are typed separated by a dash.

42.5 Changing the Password

This command is used to change the password for Enable mode. By default the same password is used to enter the command line interface (CLI) and Enable and Config modes of the CLI.

The password you change with this command is required to enter Enable and Config modes of the CLI.

Syntax:

```
password <password>
```

where

`password <password>` = Specifies the new password (up to 32 alphanumeric characters) users have to type in to enter Enable and Config modes.

42.6 Privilege Levels

You can use a command whose privilege level is equal to or less than that of your login account. For example, if your login account has a privilege level of 12, you can use all commands with privilege levels from 0 to 12. 0 privilege level commands are available to all login accounts.

Note: If you use an external RADIUS server to authenticate users, you can use a VSA (Vendor Specific Attribute) to configure a privilege level for an account on the RADIUS server. See [Section 16.1.1.1 on page 119](#) for more information.

Use the following commands to specify privilege levels for login accounts.

Syntax:

```
logins username <username> password <password>
logins username <username> privilege <0-14>
```

where

`username <username>` = Specifies a new user (up to 32 alphanumeric characters). Enter a user name to change the settings of an existing account.

`password <password>` = Specifies the new password (up to 32 alphanumeric characters) for this user.

`privilege <0-14>` = Assigns a privilege level for the user.

42.7 Command Modes

There are three command modes: **User**, **Enable** and **Configure**. The modes (and commands) available to you depend on what level of privilege your account has. See [Section 42.6 on page 255](#) for more information on setting up privilege levels.

When you first log into the command interpreter with a read-only account (having a privilege of 0 to 12), the initial mode is the User mode. The User mode commands are a subset of Enable mode commands. The User mode command prompt ends with an angle bracket (>).

To enter Enable mode, type `enable` and enter the administrator password when prompted (the default is 1234). When you enter Enable mode, the command prompt changes to the pound sign (#). If you log into the command interpreter as an administrator you automatically enter Enable mode.

The following table describes command interpreter modes and how to access them.

Table 103 Command Interpreter Mode Summary

MODE	DESCRIPTION	HOW TO LOGIN/ ACCESS	PROMPT
User	Commands available in this mode are a subset of enable mode. You can perform basic tests and display general system information.	Default login level for a read-only account.	<code>sysname></code> The first part of the prompt is the system name. In the CLI examples in this User's Guide, the system name is always "sysname".
Enable	Commands available in this mode allow you to save configuration settings, reset configuration settings as well as display further system information. This mode also contains the <code>configure</code> command which takes you to config mode.	Default login level for accounts with a privilege of 13 or 14. Read-only accounts (with a privilege of 0-12) need to type the <code>enable</code> command and enter enable mode password.	<code>sysname#</code>

Table 103 Command Interpreter Mode Summary (continued)

MODE	DESCRIPTION	HOW TO LOGIN/ ACCESS	PROMPT
Config	Commands available in this mode allow you to configure settings that affect the switch globally.	Type <code>config</code> in enable mode.	<code>sysname(config)#</code>
Command modes that follow are sub-modes of the config mode and can only be accessed from within the config mode.			
Config-vlan	This is a sub-mode of the config mode and allows you to configure VLAN settings.	Type <code>vlan</code> followed by a number (between 1 to 4094). For example, <code>vlan 10</code> to configure settings for VLAN 10.	<code>sysname(config-vlan)#</code>
Config-interface	This is a sub-mode of the config mode and allows you to configure port related settings.	Type <code>interface port-channel</code> followed by a port number. For example, <code>interface port-channel 8</code> to configure port 8 on the switch.	<code>sysname(config-interface)#</code>
Config-mvr	This is a sub-mode of the config mode and allows you to configure multicast VLAN settings.	To enter MVR mode, enter <code>mvr</code> followed by a VLAN ID (between 1 and 4094). For example, enter <code>mvr 2</code> to configure multicast settings on VLAN 2.	<code>sysname(config-mvr)#</code>

Enter `exit` to quit from the current mode or enter `logout` to exit the command interpreter.

42.8 Getting Help

The system includes a help facility to provide you with the following information about the commands:

- List of available commands under a command group.
- Detailed descriptions of the commands.

42.8.1 List of Available Commands

Enter “help” to display a list of available commands and the corresponding sub commands.

```
sysname> help
  Commands available:

  help
  logout
  exit
  history
  enable
  show ip <cr>
  show hardware-monitor <C|F>
  show system-information
  ping <ip|host-name> <cr>
  ping <ip|host-name> [vlan <vlan-id>][..]
  ping help
  traceroute <ip|host-name> <cr>
  traceroute <ip|host-name> [vlan <vlan-id>][..]
  traceroute help
  ssh <1|2> <[user@]dest-ip> <cr>
  ssh <1|2> <[user@]dest-ip> [command </>]
sysname>
```

Enter “?” to display a list of commands you can use.

```
sysname> ?
  enable          Turn on privileged commands
  exit            Exit from the EXEC
  help            Description of the interactive help system
  history         Show a list of previously run commands
  logout          Exit from the EXEC
  ping            Exec ping
  show            Show system information
  ssh             SSH client
  traceroute     Exec traceroute
sysname>
```

Enter <command> help to display detailed sub commands and parameters.

```
sysname> ping help
  Commands available:

  ping <ip|host-name>
  <
    [ in-band|out-of-band|vlan <vlan-id> ]
    [ size <0-1472> ]
    [ -t ]
  >
sysname>
```

Enter `<command> ?` to display detailed help information about the sub commands and parameters.

```
sysname> ping ?
  <ip|host-name>      destination ip address
  help                Description of ping help
sysname>
```

42.9 Using Command History

The switch keeps a list of recently used commands available to you for reuse. You can use any commands in the history again by pressing the up (▲) or down (▼) arrow key to scroll through the previously used commands and press [ENTER]. Use the history command to display the list of commands.

```
sysname> history
  enable
  exit
  show ip
  history
sysname>
```

42.10 Saving Your Configuration

After you set the switch settings with the configuration commands, use the `write memory` command to save the changes permanently.

Note: The `write memory` command is not available in User mode.

You must save your changes after each CLI session. All unsaved configuration changes are lost once you restart the switch.

```
sysname# write memory
```

42.10.1 Switch Configuration File

When you configure the switch using either the CLI (Command Line Interface) or web configurator, the settings are saved as a series of commands in a configuration file on the switch. You can perform the following with a configuration file:

- Back up switch configuration once the switch is set up to work in your network.
- Restore switch configuration.

- Use the same configuration file to set all switches (of the same model) in your network to the same settings.

Note: You may also edit a configuration file using a text editor.

Make sure you use valid commands. The switch rejects configuration files with invalid or incomplete commands.

42.10.2 Logging Out

In User or Enable mode, enter the `exit` or `logout` command to log out of the CLI. In Config mode entering `exit` takes you out of the Config mode and into Enable mode and entering `logout` logs you out of the CLI.

42.11 Command Summary

The following sections summarize the commands available in the switch together with a brief description of each command. Commands listed in the tables are in the same order as they are displayed in the CLI. See the related section in the User's Guide for more background information.

42.11.1 User Mode

The following table describes the commands available for User mode.

Table 104 Command Summary: User Mode

COMMAND		DESCRIPTION	PRIVILEGE
help		Displays help information.	0
logout		Exits from the CLI.	0
exit		Logs out from the CLI.	0
history		Displays a list of previously command(s) that you have executed. The switch stores up to 256 commands in history.	0
enable		Accesses Enable (or privileged) mode. See Section 42.11.2 on page 261 .	0
show	ip	Displays IP related information.	0
	hardware-monitor <C F>	Displays current hardware monitor information with the specified temperature unit (Celsius C or Fahrenheit F).	0
	system-information	Displays general system information.	0
ping	<IP host-name>	Sends Ping request to an Ethernet device.	0

Table 104 Command Summary: User Mode (continued)

COMMAND		DESCRIPTION	PRIVILEGE
	<IP host-name> [vlan <vlan-id>] [size <0-1472>] [-t]	Sends Ping request to an Ethernet device in the specified VLAN(s) with the specified parameters.	0
	help	Displays command help information.	0
traceroute	<ip host-name>	Determines the path a packet takes to a device.	0
	<ip host-name> [vlan <vlan-id>] [ttl <1-255>] [wait <1-60>] [queries <1-10>]	Determines the path a packet takes to a device in a VLAN.	0
	help	Displays command help information.	0
ssh	<1 2> <[user@]dest-ip>	Connects to an SSH server with the specified SSH version.	0

42.11.2 Enable Mode

The following table describes the commands available for Enable mode.

Table 105 Command Summary: Enable Mode

COMMAND		DESCRIPTION	PRIVILEGE	
baudrate <1 2 3 4 5>		Changes the console port speed. Choices are 1 (9600), 2 (19200), 3(38400), 4 (57600) and 5 (115200).	13	
boot	config <index>	Restarts the system with the specified configuration file.	13	
configure		Accesses Configuration mode. See Section 42.11.3 on page 267 .	13	
copy	running-config tftp <ip> <remote-file>	Backs up running configuration to the specified TFTP server with the specified file name.	13	
	running-config interface port-channel <port> <port-list>	Clones (copies) the attributes from the specified port to other ports.	13	
	running-config interface port-channel <port> <port-list>	[bandwidth-limit] Copies the specified attributes from one port to other ports.	13	
	tftp	config <index> <ip> <remote-file>	Restores configuration with the specified filename from the specified TFTP server to the specified configuration file on the router.	13

Table 105 Command Summary: Enable Mode (continued)

COMMAND			DESCRIPTION	PRIVILEGE
		flash <ip> <remote-file>	Restores firmware via TFTP.	13
disable			Exits Enable (or privileged) mode.	13
enable			Accesses Enable (or privileged) mode.	13
erase	running-config		Resets to the factory default settings.	13
		interface port-channel <port-list> [bandwidth-limit...]	Resets to the factory default settings on a per port basis and optionally on a per feature configuration basis.	13
exit			Exits Enable (or privileged) mode.	13
help			Displays help information.	13
history			Displays a list of command(s) that you have previously executed.	13
igmp-flush			Removes all IGMP information.	13
kick	tcp <Session ID>		Disconnects the specified TCP session.	13
logout			Exits Enable (or privileged) mode.	13
mac-flush			Clears the MAC address table.	13
	<port-num>		Removes all learned MAC address on the specified port(s).	13
no	logging		Disables syslog logging.	13
ping <IP host-name>			Sends Ping request to an Ethernet device.	13
	[vlan <vlan-id>][...]		Sends Ping request to an Ethernet device in the specified VLAN(s).	13
reload	config <index>		Restarts the system and use the specified configuration file.	13
show	classifier		Displays all classifier related information.	13
		[name]	Displays the specified classifier related information.	13
	cluster		Displays cluster management status.	13
		candidates	Displays cluster candidate information.	13
		member	Displays the MAC address of the cluster member(s).	13
		member config	Displays the configuration of the cluster member(s).	13

Table 105 Command Summary: Enable Mode (continued)

COMMAND		DESCRIPTION	PRIVILEGE
		member mac <mac-addr>	Displays the status of the cluster member(s). 13
	dhcp	relay	Displays DHCP relay settings. 13
		server	Displays DHCP server settings. 13
		server <vlnd-id>	Displays DHCP server settings in a specified VLAN. 13
	diffserv		Displays general DiffServ settings. 13
	garp		Displays GARP information. 13
	hardware-monitor	<C F>	Displays current hardware monitor information with the specified temperature unit (Celsius C or Fahrenheit F). 13
	https		Displays the HTTPS information. 13
		certificate	Displays the HTTPS certificates. 13
		key <rsa dsa>	Displays the HTTPS key. 13
		session	Displays current HTTPS session(s). 13
		timeout	Displays the HTTPS session timeout. 13
	igmp-filtering	profile [name]	Displays IGMP filtering profile settings. 13
	igmp-snooping		Displays global IGMP snooping settings. 13
	interface <port-number>		Displays current interface status. 13
	interfaces <port-list>		Displays current interfaces status. 13
	interfaces config <port-list>		Displays current interface configuration. 13
		bandwidth-control	Displays bandwidth control settings. 13
		bstorm-control	Displays broadcast storm control settings. 13
		egress	Displays outgoing port information. 13
		igmp-filtering	Displays IGMP filtering settings. 13
		igmp-group-limited	Displays the IGMP group limit. 13
		igmp-immediate-leave	Displays the IGMP Immediate Leave setting. 13
		igmp-query-mode	Displays IGMP query mode for the specified port. 13
	ip		Displays IP related information. 13

Table 105 Command Summary: Enable Mode (continued)

COMMAND		DESCRIPTION	PRIVILEGE
	arp	Displays the ARP table.	13
	dvmrp group	Displays DVMRP group information.	13
	dvmrp interface	Displays DVMRP interface information.	13
	dvmrp neighbour	Displays DVMRP neighbour information.	13
	dvmrp prune	Displays the DVMRP prune information.	13
	dvmrp route	Displays the DVMRP routes.	13
	igmp	Displays the IGMP setting.	13
	iptable all [IP VID PORT]	Displays the IP address table. You can sort the table based on the IP address, VLAN ID or the port number.	13
	iptable count	Displays the number of IP addresses in the IP table.	13
	iptable static	Displays the status IP address table.	13
	ospf database	Displays OSPF link state database information.	13
	ospf interface	Displays OSPF interface settings.	13
	ospf neighbor	Displays OSPF neighbor information.	13
	route	Displays IP routing information.	13
	route static	Displays IP static route information.	13
	tcp	Displays IP TCP information.	13
	udp	Displays IP UDP information.	13
	lacp	Displays LACP (Link Aggregation Control Protocol) settings.	13
	logging	Displays system logs.	13
	loginPrecedence	Displays login precedence settings.	13
	logins	Displays login account information.	13
	mac address-table <all [mac vid port]>	Displays MAC address table. You can sort by MAC address, VID or port.	13
	address-table static	Displays static MAC address table.	13
	address-table count	Displays the number of entries in the MAC address table.	13
	mac-aging-time	Displays MAC learning aging time.	13

Table 105 Command Summary: Enable Mode (continued)

COMMAND		DESCRIPTION	PRIVILEGE	
	mac-count		Displays the count of MAC addresses learnt.	13
	mrstp <tree-index>		Displays multiple rapid spanning tree configuration for the specified tree.	13
	multicast		Displays multicast settings.	13
	multi-login		Displays multi-login information	14
	mvr		Displays all MVR settings.	13
		<VID>	Displays the specified MVR group settings.	13
	policy		Displays all policy related information.	13
		[name]	Displays the specified policy related information.	13
	port-access-authenticator		Displays all port authentication settings.	13
		[port-list]	Displays port authentication settings on the specified port(s).	13
	port-security		Displays all port security settings.	13
		[port-list]	Displays port security settings on the specified port(s).	13
	radius-server		Displays RADIUS server settings.	13
	remote-management		Displays all secured client information.	13
		[index]	Displays the specified secured client information.	13
	router	dvmp	Displays DVMP settings.	13
		igmp	Displays global IGMP settings.	13
		ospf	Displays OSPF settings.	13
		ospf area	Displays OSPF area settings.	13
		ospf network	Displays OSPF network (or interface) settings.	13
		ospf redistribute	Displays OSPF redistribution settings.	13
		ospf virtual-link	Displays OSPF virtual link settings.	13
		rip	Displays global RIP settings.	13
		vrrp	Displays VRRP settings.	13
	running-config		Displays current operating configuration.	13

Table 105 Command Summary: Enable Mode (continued)

COMMAND			DESCRIPTION	PRIVILEGE
		interface port-channel <port-list> [bandwidth-limit...]	Displays current operating configuration on a port by port basis. Optionally specifies which settings are displayed.	13
	service-control		Displays service control settings.	13
	snmp-server		Displays SNMP settings.	13
	spanning-tree	config	Displays Spanning Tree Protocol (STP) settings.	13
	ssh		Displays general SSH settings.	13
		known-hosts	Displays known SSH hosts information.	13
		key <rsa rsa dsa>	Displays internal SSH public and private key information.	13
		session	Displays current SSH session(s).	13
	system-information		Displays general system information.	13
	time		Displays current system time and date.	13
	timesync		Displays time server information.	13
	trunk		Displays link aggregation information.	13
	vlan		Displays the status of all VLANs.	13
		<vlan-id>	Displays the status of the specified VLAN.	13
	vlan-stacking		Displays VLAN stacking settings.	13
	vlanlq	gvrp	Displays GVRP settings.	13
		port-isolation	Displays port isolation settings.	13
ssh	<1 2> <[user@]dest-ip>		Connects to an SSH server with the specified SSH version.	13
		[command </>]	Connects to an SSH server with the specified SSH version and addition commands to be executed on the server.	13
traceroute	<ip host-name> [in-band out-of-band vlan <vlan-id>][ttl <1-255>] [wait <1-60>] [queries <1-10>]		Determines the path a packet takes to a device.	13
	help		Displays help information for this command.	13

Table 105 Command Summary: Enable Mode (continued)

COMMAND		DESCRIPTION	PRIVILEGE	
write	memory		Saves current configuration to the configuration file the switch is currently using.	13
		<index>	Saves current configuration to the specified configuration file on the switch.	13

42.11.3 General Configuration Mode

The following table lists the commands in Configuration (or Config) mode.

Table 106 Command Summary: Configuration Mode

COMMAND		DESCRIPTION	PRIVILEGE	
admin- password	<pw-string> <confirm-string>		Changes the administrator password.	14
bandwidth- control			Enables bandwidth control.	13
bcp- transparen cy			Enables Bridge Control Protocol (BCP) transparency.	13

Table 106 Command Summary: Configuration Mode (continued)

COMMAND		DESCRIPTION	PRIVILEGE	
classifier	<name> <[packet-format <802.3untag 802.3tag EtherIUntag EtherIItag>] [priority <0-7>] [vlan <vlan-id>][ethernet-type <ethernet-num ip ipx arp rarp appletalk decnet sna netbios dlc>] [source-mac <src-mac-addr>] [source-port <port-num>] [destination-mac <dest-mac-addr>] [dscp <0-63>] [ip-protocol <protocol-num tcp udp icmp egp ospf rsvp igmp igp pim ipsec> [establish-only]] [source-ip <src-ip-addr> [mask-bits <mask-bits>]] [source-socket <socket-num>] [destination-ip <dest-ip-addr> [mask-bits <mask-bits>]] [destination-socket <socket-num>] [inactive]>	Configures a classifier. A classifier groups traffic into data flows according to specific criteria such as the source address, destination address, source port number, destination port number or incoming port number.	13	
	help		Displays help information for this command.	13
cluster	<vlan-id>		Enables clustering in the specified VLAN group.	13
	member <mac-address> password <password-str>		Sets the cluster member.	13
	name <cluster name>		Sets a descriptive name for the cluster.	13
	rcommand <mac-address>		Logs into the CLI of the specified cluster member.	13

Table 106 Command Summary: Configuration Mode (continued)

COMMAND		DESCRIPTION	PRIVILEGE	
default-management	<in-band out-of-band>		Specifies through which traffic flow the switch is to send packets.	13
dhcp	relay		Enables DHCP relay.	13
		helper-address <remote-dhcp-server1> <remote-dhcp-server2> <remote-dhcp-server3>	Sets the IP addresses of up to 3 DHCP servers.	13
		information	Allows the switch to add system name to agent information.	13
		option	Allows the switch to add DHCP relay agent information.	13
	server <vlan-id>	starting-address <ip-addr> <subnet-mask> size-of-client-ip-pool <1-253> [default-gateway <ip-addr>] [primary-dns <ip-addr>] [secondary-dns <ip-addr>]	Configures a DHCP server for the specified VLAN. Optionally specifies the default gateway and DNS servers for this DHCP server to assign.	13
diffserv			Enables DiffServ.	13
	dscp <0-63> priority <0-7>		Sets the DSCP-to-IEEE 802.1q mappings.	13
exit			Exits from the CLI.	13
garp	join <100-65535> leave <msec> leaveall <msec>		Configures GARP time settings.	13
help			Displays help information.	13
history			Displays a list of previous command(s) that you have executed.	13
hostname	<name_string>		Sets the switch's name for identification purposes.	13
https	cert-regeneration <rsa dsa>		Re-generates a certificate.	13
	timeout <0-65535>		Sets the HTTPS timeout period.	13
igmp-filtering			Enables IGMP filtering on the switch.	13

Table 106 Command Summary: Configuration Mode (continued)

COMMAND			DESCRIPTION	PRIVILEGE
	profile <name> start-address <ip> end-address <ip>		Sets the range of multicast address(es) in a profile.	13
igmp-snooping			Enables IGMP snooping.	13
	8021p-priority	<0-7>	Sets the 802.1p priority for outgoing igmp snooping packets.	13
	host-timeout	<1-16711450>	Sets the host timeout value.	13
	leave-timeout	<1-16711450>	Sets the leave timeout value	13
	unknown-multicast-frame <drop flooding>		Sets how to treat traffic from unknown multicast group.	13
	reserved-multicast-group <drop flooding>		Sets how to treat traffic belonging to reserved multicast groups.	13
interface	port-channel <port-list>		Enables a port or a list of ports for configuration. See Section 42.11.4 on page 283 for more details.	13
	route-domain <ip-address>/<mask-bits>		Enables a routing domain for configuration. See Section 42.11.5 on page 287 for more details.	13
ip	address	<ip> <mask>	Sets the IP address and subnet mask of the out-of-band management port.	13
		default-gateway <ip>	Sets the default gateway's IP address for the out-of-band management port.	13
	name-server	<ip>	Sets the IP address of a domain name server.	13
	route	<ip> <mask> <next-hop-ip>	Creates a static route.	13
		<ip> <mask> <next-hop-ip> [metric <metric>] [name <name>] [inactive]	Sets the metric of a static route or deactivates a static route.	13
lacp			Enables Link Aggregation Control Protocol (LACP).	13
	system-priority	<1-65535>	Sets the priority of an active port using LACP.	13
loginPrecedence	<LocalOnly LocalRADIUS RADIUSOnly>		Select which database the switch should use (first) to authenticate a user.	13

Table 106 Command Summary: Configuration Mode (continued)

COMMAND		DESCRIPTION	PRIVILEGE
logins	username <name> password <pwd>		Configures up to four read-only login accounts. 14
	username <name>	privilege <0-14>	Assigns a privilege level to user accounts. 14
logout			Exits from the CLI. 13
mac-aging-time	<10-3000>		Sets learned MAC aging time. 13
mac-filter	name <name> mac <mac-addr> vlan <vlan-id> drop <src/dst/both>		Configures a static MAC address port filtering rule. 13
		inactive	Disables a static MAC address port filtering rule. 13
mac-forward	name <name> mac <mac-addr> vlan <vlan-id> interface <interface-id>		Configures a static MAC address forwarding rule. 13
		inactive	Disables a static MAC address forwarding rule. 13
mirror-port			Enables port mirroring. 13
	<port-num>		Enables port mirroring on a specified port. 13
mode	zynos		Changes the CLI mode to the ZYNOS format. 13
mrstp	<tree-index>		Activates the specified STP configuration. 13
		priority <0-61440>	Sets the priority for the specified tree. 13
		hello-time <1-10> maximum-age <6-40> forward-delay <4-30>	Sets hello-time, maximum-age and forward delay for the specified tree. 13
	interface <port-list>		Activates STP on the specified ports. 13
		path-cost <1-65535>	Sets a path cost to the specified ports. 13
		priority <0-255>	Sets the priority value to the specified ports for STP. 13
		tree-index <1-4>	Assigns a specific STP configuration to the ports. 13
	help		Displays the detailed help for the mrstp command. 13

Table 106 Command Summary: Configuration Mode (continued)

COMMAND		DESCRIPTION	PRIVILEGE	
multi-login		Enables multi-login.	14	
mvr	<vlan-id>	Enters the MVR (Multicast VLAN Registration) configuration mode. Refer to Section 42.12 on page 289 for more information.	13	
no	bandwidth-control	Disable bandwidth control on the switch.	13	
	bcp-transparency		13	
	classifier	<name>	Disables the classifier. Each classifier has one rule. If you disable a classifier you cannot use policy rule related information.	13
		<name> inactive	Enables a classifier.	13
	cluster		Disables cluster management on the switch.	13
		member <mac-address>	Removes the cluster member.	13
	dhcp relay		Disables DHCP relay.	13
		information	Disables the relay agent information option 82.	13
		option	System name is not appended to option 82 information field.	13
	dhcp server <vlan-id>		Disables DHCP server settings.	13
		default-gateway	Disables DHCP server default gateway settings.	13
		primary-dns	Disables DHCP primary DNS server settings.	13
		secondary-dns	Disables DHCP server secondary DNS settings.	13
	diffserv		Disables the DiffServ settings.	13
	https	timeout	Resets the session timeout to the default of 300 seconds.	13
	igmp-filtering		Disables IGMP filtering on the switch.	13
		profile <name>	Disables the specified IGMP filtering profile.	13
		profile <name> start-address <ip> end-address <ip>	Clears the settings of the specified IGMP filtering profile.	13
	igmp-snooping		Disables IGMP snooping.	13

Table 106 Command Summary: Configuration Mode (continued)

COMMAND		DESCRIPTION	PRIVILEGE	
	ip		Sets the management IP address to the default value.	13
		route <ip> <mask>	Removes a specified IP static route.	13
		route <ip> <mask> inactive	Enables a specified IP static route.	13
	lacp		Disables the link aggregation control protocol (dynamic trunking) on the switch.	13
	logins <name>		Disables login access to the specified name.	14
	mac-filter	name <name> mac <mac-addr> vlan <vlan-id> drop <src dst both> inactive	Enables the specified MAC-filter rule.	13
		name <name> mac <mac-addr> vlan <vlan-id> drop <src dst both>	Disables the specified MAC filter rule.	13
	mac-forward	name <name> mac <mac-addr> vlan <vlan-id> interface <interface-id>	Removes the specified MAC forwarding entry, belonging to a VLAN group (if any) forwarded through an interface(s).	13
		name <name> mac <mac-addr> vlan <vlan-id> interface <interface-id> inactive	Enables the specified MAC address, belonging to a VLAN group (if any) forwarded through an interface(s).	13
	mirror-port		Disables port mirroring on the switch.	13
	mrstp	<treeIndex>	Disables the specified STP configuration.	13
	mrstp	interface <port-list>	Disables the STP assignment from the specified port(s).	13
	multi-login		Disables another administrator from logging into Telnet or the CLI.	14
	mvr <vlan-id>		Disables MVR on the switch.	13
	policy <name>		Deletes the policy. A policy sets actions for the classified traffic.	13
		inactive	Enables a policy.	13

Table 106 Command Summary: Configuration Mode (continued)

COMMAND		DESCRIPTION	PRIVILEGE	
	port-access-authenticator		Disables port authentication on the switch.	13
		<port-list>	Disables authentication on the listed ports.	13
		<port-list> reauthenticate	Disables the re-authentication mechanism on the listed port(s).	13
	port-security		Disables port security on the device.	13
		<port-list>	Disables port security on the specified ports.	13
		<port-list> learn inactive	Enables MAC address learning on the specified ports.	13
	radius-server	<index>	Disables the use of authentication from the specified RADIUS server.	13
	remote-management	<index>	Clears a secure client set entry from the list of secure clients.	13
		<index> service <telnet ftp http icmp snmp ssh https>	Disables a secure client set entry number from using the selected remote management service.	13
	router	dvmrp	Disables DVMRP on the switch.	13
		igmp	Disables IGMP on the switch.	13
		ospf	Disables OSPF on the switch.	13
		rip	Disable RIP on the switch.	13
		vrrp network <ip-address>/ <mask-bits> vr-id <1-7>	Deletes VRRP settings.	13
	service-control	ftp	Disables FTP access to the switch.	13
		http	Disables web browser control to the switch.	13
		https	Disables secure web browser access to the switch.	13
		icmp	Disables ICMP access to the switch such as pinging and tracerouting.	13
		snmp	Disables SNMP management.	13
		ssh	Disables SSH (Secure Shell) server access to the switch.	13
		telnet	Disables telnet access to the switch.	13

Table 106 Command Summary: Configuration Mode (continued)

COMMAND			DESCRIPTION	PRIVILEGE
	snmp-server	trap-destination <ip>	Disables sending of SNMP traps to a station.	13
	spanning-tree		Disables STP.	13
		<port-list>	Disables STP on listed ports.	13
	ssh	key <rsa1 rsa dsa>	Disables the secure shell server encryption key. Your switch supports SSH versions 1 and 2 using RSA and DSA authentication.	13
		known-hosts <host-ip>	Removes the specified remote hosts from the list of all known hosts.	13
		known-hosts <host-ip> [1024 ssh-rsa ssh-dsa]	Removes remote known hosts with the specified public key (1024-bit RSA1, RSA or DSA).	13
	storm-control		Disables broadcast storm control.	13
	syslog		Disables syslog logging.	13
		server <ip-address>	Disables syslog logging to the specified syslog server.	13
		server <ip-address> inactive	Enables syslog logging to the specified syslog server.	13
		type [type]	Disables syslog logging for the specified log type (sys, link, config, error or report).	13
	timesync		Disables timeserver settings.	13
	trunk	<T1 T2 T3 T4 T5 T6>	Disables the specified trunk group.	13
		<T1 T2 T3 T4 T5 T6> interface <port-list>	Removes ports from the specified trunk group.	13
		<T1 T2 T3 T4 T5 T6> lacp	Disables LACP in the specified trunk group.	13
	vlan	<vlan-id>	Deletes the static VLAN entry.	13
	vlanlq	gvrp	Disables GVRP on the switch.	13
		port-isolation	Disables port isolation.	13
	vlan-stacking		Disables VLAN stacking.	13
password			Change the password for Enable mode.	14

Table 106 Command Summary: Configuration Mode (continued)

COMMAND		DESCRIPTION	PRIVILEGE	
policy	<pre> <name> classifier <classifier-list> < [vlan<vlan-id>] [egress-port <port-num>] [priority <0-7>] [dscp <0-63>] [tos <0-7>] [bandwidth <bandwidth>] [outgoing-packet- format <tagged untagged>] [out-of-profile- dscp <0-63>] [forward-action <drop forward>] [queue-action <prio-set prio- queue prio- replace-tos>] [diffserv-action <diff-set- tos diff-replace- priority diff- set-dscp>] [outgoing-mirror] [outgoing-eport] [outgoing-non- unicast-eport] [outgoing-set- vlan] [metering] [out-of-profile- action <[change- dscp][drop][forwa- rd] [set-drop- precedence]>] [inactive]> </pre>	Configures a policy. A classifier distinguishes traffic into flows based on the configured criteria. A policy rule ensures that a traffic flow gets the requested treatment in the network.	13	
port-access-authenticator		Enables 802.1x authentication on the switch.	13	
	<port-list>	Enables 802.1x authentication on the specified port(s).	13	
		reauthenticate	Sets a subscriber to periodically re-enter his or her username and password to stay connected to a specified port.	13

Table 106 Command Summary: Configuration Mode (continued)

COMMAND			DESCRIPTION	PRIVILEGE
		reauth-period <reauth- period>	Specifies how often a client has to re-enter the username and password to stay connected to the specified port(s).	13
port-security			Enables port security on the device.	13
	<port-list>		Enables port security on the specified port(s).	13
		learn inactive	Disables MAC address learning on the specified port(s).	13
		address-limit <number>	Limits the number of (dynamic) MAC addresses that may be learned on a port.	13
		MAC-freeze	Adds learned MAC addresses to the static MAC table and stops learning any more MAC addresses.	13
queue	priority <0-7> level <0-7>		Sets the priority level-to-physical queue mapping.	13
radius-server	host <index> <ip>		Specifies the IP address of RADIUS server 1 or RADIUS server 2 (index =1 or index =2).	13
		[auth-port <socket- number>] [key <key-string>]	Sets the port number and key of the external RADIUS server.	13
	timeout <1-1000>		Specifies the RADIUS server timeout value.	13
	mode	<priority round-robin>	Specifies the mode for RADIUS server selection.	13
remote-management	<index> start- addr <ip> end- addr <ip> service <telnet ftp http icmp snmp>		Specifies a group of trusted computer(s) from which an administrator may use a service to manage the switch.	13
router	dvmrp		Enables and enters the DVMRP configuration mode.	13
		exit	Leaves the DVMRP configuration mode.	13
		threshold <tthl-value>	Sets the DVMRP threshold value.	13
	igmp		Enables and enters the IGMP configuration mode.	13
		exit	Leaves the IGMP configuration mode.	13
		non-querier	Sets the switch into a non-querier mode. It will not send igmp query messages.	13

Table 106 Command Summary: Configuration Mode (continued)

COMMAND		DESCRIPTION	PRIVILEGE
	no non-querier	Disables non-querier mode on the switch.	13
	ospf <router-id>	Enables and enters the OSPF configuration mode.	13
	area <area-id>	Enables and sets the area ID.	13
	area <area-id> authentication	Enables simple authentication for the area.	13
	area <area-id> authentication message-digest	Enables MD5 authentication for the area.	13
	area <area-id> default-cost <0-16777214>	Sets the cost to the area.	13
	area <area-id> name <name>	Sets a descriptive name for the area for identification purposes.	13
	area <area-id> stub	Enables and sets the area as a stub area.	13
	area <area-id> stub no- summary	Sets the stub area not to send any LSA (Link State Advertisement).	13
	area <area-id> virtual-link <router-id>	Sets the virtual link ID information for the area.	13
	area <area-id> virtual-link <router-id> authentication -key <key>	Enables simple authentication and sets the authentication key for the specified virtual link in the area.	13
	area <area-id> virtual-link <router-id> authentication -same-as-area	Sets the virtual link to use the same authentication method as the area.	13
	area <area-id> virtual-link <router-id> message- digest-key <keyid> md5 <key>	Enables MD5 authentication and sets the key ID and key for the virtual link in the area.	13
	area <area-id> virtual-link <router-id> name <name>	Sets a descriptive name for the virtual link for identification purposes.	13
	exit	Leaves the router OSPF configuration mode.	13

Table 106 Command Summary: Configuration Mode (continued)

COMMAND		DESCRIPTION	PRIVILEGE
	<code>network <ip-addr/bits> area <area-id></code>	Creates an OSPF area.	13
	<code>no area <area-id></code>	Removes the specified area.	13
	<code>no area <area-id> authentication</code>	Sets the area to use no authentication (None).	13
	<code>no area <area-id> default-cost</code>	Sets the area to use the default cost (15).	13
	<code>no area <area-id> stub</code>	Disables stub network settings in the area.	13
	<code>no area <area-id> stub no-summary</code>	Sets the area to send LSAs (Link State Advertisements).	13
	<code>no area <area-id> virtual-link <router-id> authentication-key</code>	Resets the authentication settings on this virtual link.	13
	<code>no area <area-id> virtual-link <router-id> message-digest-key</code>	Resets the authentication settings on this virtual link.	13
	<code>no area <area-id> virtual-link <router-id> authentication-same-as-area</code>	Resets the authentication settings on this virtual area.	13
	<code>no area <area-id> virtual-link <router-id></code>	Deletes the virtual link from the area.	13
	<code>no network <ip-addr/bits></code>	Deletes the OSPF network.	13
	<code>no redistribute rip</code>	Sets the switch not to learn RIP routing information.	13
	<code>no redistribute static</code>	Sets the switch not to learn static routing information.	13

Table 106 Command Summary: Configuration Mode (continued)

COMMAND		DESCRIPTION	PRIVILEGE
		redistribute rip metric- type <1 2> metric <0- 65535>	13
		redistribute static metric- type <1 2> metric <0- 65535>	13
		passive-iface <ip-addr/bits>	13
	rip		13
		exit	13
	vrrp network <ip- address>/<mask- bits> vr-id <1-7> uplink-gateway <ip>		13
		exit	13
		inactive	13
		interval <1..255>	13
		name <name string>	13
		no inactive	13
		no preempt	13
		no primary- virtual-ip	13
		no secondary- virtual-ip	13
		preempt	13
		primary- virtual-ip <ip>	13
		priority <1- 254>	13

Table 106 Command Summary: Configuration Mode (continued)

COMMAND		DESCRIPTION	PRIVILEGE
	secondary-virtual-ip <ip>	Sets the secondary VRRP virtual gateway IP address.	13
service-control	ftp <socket-number>	Allows FTP access on the specified service port.	13
	http <socket-number> <timeout>	Allows HTTP access on the specified service port and defines the timeout period.	13
	https <socket-number>	Allows HTTPS access on the specified service port.	13
	icmp	Allows ICMP management packets.	13
	snmp	Allows SNMP management.	13
	ssh <socket-number>	Allows SSH access on the specified service port.	13
	telnet <socket-number>	Allows Telnet access on the specified service port.	13
snmp-server	[contact <system contact>] [location <system location>]	Sets the geographic location and the name of the person in charge of this switch.	13
	get-community <property>	Sets the get community.	13
	set-community <property>	Sets the set community.	13
	trap-community <property>	Sets the trap community.	13
	trap-destination <ip>	Sets the IP addresses of up to four stations to send your SNMP traps to.	13
spanning-tree		Enables STP on the switch.	13
	<port-list>	Enables STP on a specified port.	13
	<port-list> path-cost <1-65535>	Sets the STP path cost for a specified port.	13
	<port-list> priority <0-255>	Sets the priority for a specified port.	13
	hello-time <1-10> maximum-age <6-40> forward-delay <4-30>	Sets Hello Time, Maximum Age and Forward Delay.	13
	help	Displays help information.	13
	priority <0-61440>	Sets the bridge priority of the switch.	13

Table 106 Command Summary: Configuration Mode (continued)

COMMAND			DESCRIPTION	PRIVILEGE
ssh	known-hosts <host-ip> <1024 ssh- rsa ssh-dsa> <key>		Adds a remote host to which the switch can access using SSH service.	13
storm-control			Enables broadcast storm control on the switch.	13
syslog			Enables syslog logging.	13
	server <ip-address>	inactive	Disables syslog logging to the specified syslog server.	13
		level [0 ~ 7]	Sets the IP address of the syslog server and the severity level.	13
	type <type> facility [local 1 ..7]		Sets the log type and the file location on the syslog server.	13
time	<Hour:Min:Sec>		Sets the time in hour, minute and second format.	13
	date <month/day/ year>		Sets the date in year, month and day format.	13
	help		Displays help information.	13
	timezone <- 1200 ... 1200>		Selects the time difference between UTC (formerly known as GMT) and your time zone.	13
timesync	<daytime time ntp >		Sets the time server protocol.	13
	server <ip>		Sets the IP address of your time server.	13
trunk	<T1 T2 T3 T4 T5 T 6>		Activates a trunk group.	13
	<T1 T2 T3 T4 T5 T 6>lacp		Enables LACP for a trunk group.	13
	<T1 T2 T3 T4 T5 T 6>interface <port-list>		Adds a port(s) to the specified trunk group.	13
	interface <port- list> timeout <lacp-timeout>		Defines the port number and LACP timeout period.	13
vlan	<vlan-id>		Enters the VLAN configuration mode. See Section 42.11.6 on page 288 for more information.	13
vlanlq	gvrp		Enables GVRP.	13
	port-isolation		Enables port-isolation.	13
vlan-stacking			Enables VLAN stacking on the switch.	13

Table 106 Command Summary: Configuration Mode (continued)

COMMAND		DESCRIPTION	PRIVILEGE
	<SPTPID>	Sets the SP TPID (Service Provider Tag Protocol Identifier).	13
vlan-type	<802.1q port-based>	Specifies the VLAN type.	13

42.11.4 interface port-channel Commands

The following table lists the `interface port-channel` commands in configuration mode. Use these commands to configure the ports.

Table 107 interface port-channel Commands

COMMAND		DESCRIPTION	PRIVILEGE
interface port-channel <port-list>		Enables a port or a list of ports for configuration.	13
	bandwidth-limit	Enables ingress (pir), cir and egress limits on the port(s).	13
		cir	Enables the guaranteed bandwidth limits for incoming traffic on the port(s).
		cir <Kbps>	Sets the guaranteed bandwidth allowed for incoming traffic on the port(s).
		pir	Enables bandwidth limits allowed for incoming traffic on the port(s).
		pir <Kbps>	Sets the maximum bandwidth allowed for incoming traffic on the port(s).
		egress	Enables bandwidth limits allowed for outgoing traffic on the port(s).
		egress <Kbps>	Sets the maximum bandwidth allowed for outgoing traffic on the port(s).
	bpdu-control <peer tunnel discard network>	Sets how Bridge Protocol Data Units (BPDUs) are used in STP port states.	13
	broadcast-limit	Enables broadcast storm control limit on the port(s).	13
		<pkt/s>	Specifies the maximum number of broadcast packets to allow through the port.
	diffserv	Enables DiffServ on the port(s).	13
	dlf-limit	Enables the Destination Lookup Failure (DLF) limit.	13

Table 107 interface port-channel Commands (continued)

COMMAND		DESCRIPTION	PRIVILEGE
	<pkt/s>	Sets the interface DLF limit in packets per second (pps).	13
egress set	<port-list>	Sets the outgoing traffic port list for a port-based VLAN.	13
exit		Exits from the interface port-channel command mode.	13
flow-control		Enables interface flow control. Flow control regulates transmissions to match the bandwidth of the receiving port.	13
frame-type	<all tagged untagged>	Choose to accept both tagged and untagged incoming frames, just tagged incoming frames or just untagged incoming frames on a port.	13
ge-spq	<q0 q1 ... q7>	Enables strict priority queuing starting with the specified queue and subsequent higher queues on the Gigabit ports.	13
gvrp		Enables this function to permit VLAN groups beyond the local switch.	13
help		Displays a description of the interface port-channel commands.	13
igmp-filtering	profile <profile>	Applies the specified IGMP filtering profile.	13
igmp-group-limited		Enables the IGMP group limiting feature.	13
	number <number>	Sets the maximum number IGMP groups allowed.	13
igmp-immediate-leave		Enables the IGMP immediate leave function.	13
igmp-querier-mode	<auto fixed edge>	Sets the IGMP query mode for the port.	13
inactive		Disables the specified port(s) on the switch.	13
ingress-check		Enables the device to discard incoming frames for VLANs that are not included in a port member set.	13
intrusion-lock		Enables intrusion lock on the port(s) and a port cannot be connected again after you disconnected the cable.	13

Table 107 interface port-channel Commands (continued)

COMMAND		DESCRIPTION	PRIVILEGE	
	ipmc egress- untag-vlan <vlan-id>		Enables the port(s) to remove specified VLAN tag from IP multicasting packets before forwarding.	13
	mirror		Enables port mirroring in the interface.	13
		dir <ingress egress both>	Enables port mirroring for incoming, outgoing or both incoming and outgoing traffic. Port mirroring copies traffic from one or all ports to another or all ports for external analysis.	13
	multicast-limit		Enables the port(s) multicast limit.	13
		<pkt/s>	Sets how many multicast packets the port(s) receives per second.	13
	name <port- name-string>		Sets a name for the port(s). Enter a descriptive name (up to nine printable ASCII characters).	13
	no	bandwidth-limit	Disables bandwidth limit on the port(s).	13
		bandwidth-limit <cir>	Disables cir bandwidth limits on the port(s).	13
		bandwidth-limit <pir>	Disables pir bandwidth limits on the port(s).	13
		bandwidth-limit <egress>	Disables egress bandwidth limits on the port(s).	13
		broadcast-limit	Disables broadcast storm control limit on the port(s).	13
		diffserv	Disables DiffServ on the port(s).	13
		dlf-limit	Disables destination lookup failure (DLF) on the switch.	13
		egress-set <port-list>	Disables the egress port setting.	13
		flow-control	Disables flow control on the port(s).	13
		ge-spq	Disables strict priority queuing on the Gigabit ports.	13
		gvrp	Disable GVRP on the port(s).	13
		igmp-filtering profile	Disables IGMP filtering.	13
		igmp-group- limit	Disables IGMP group limitation.	13
		igmp-immediate- leave	Disables the IGMP immediate leave function.	13
		inactive	Enables the port(s) on the switch.	13

Table 107 interface port-channel Commands (continued)

COMMAND		DESCRIPTION	PRIVILEGE	
		<code>ingress-check</code>	Disables ingress checking on the port(s).	13
		<code>intrusion-lock</code>	Disables intrusion-lock on a port so that a port can be connected again after you disconnected the cable.	13
		<code>ipmc egress-untag-vlan <vlan-id></code>	Disables the port(s) from removing specified VLAN tag from IP multicasting packets before forwarding.	13
		<code>mirror</code>	Disables port mirroring on the port(s).	13
		<code>multicast-limit</code>	Disables multicast limit on the port(s).	13
		<code>vlan-trunking</code>	Disables VLAN trunking on the port(s).	13
	<code>pvid <vlan-id></code>		The default PVID is VLAN 1 for all ports. Sets a PVID in the range 1 to 4094 for the specified interface.	13
	<code>qos</code>	<code>priority <0 .. 7></code>	Sets the quality of service priority for an interface.	13
	<code>speed-duplex</code>	<code><auto 10-half 10-full 100-half 100-full 1000-full></code>	Sets the duplex mode (<code>half</code> or <code>full</code>) and speed (10, 100 or 1000 Mbps) of the connection on the interface. Selecting <code>auto</code> (auto-negotiation) makes one port able to negotiate with a peer automatically to obtain the connection speed and duplex mode that both ends support.	13
	<code>spq</code>		Sets the port(s) to use Strict Priority Queuing.	13
	<code>vlan-stacking</code>	<code>priority <0-7></code>	Sets the priority of the specified port(s) in VLAN stacking.	13
		<code>role <access tunnel></code>	Sets the VLAN stacking port roles of the specified port(s).	13
		<code>SPVID <vlan-id></code>	Sets the service provider VID of the specified port(s).	13
	<code>vlan-trunking</code>		Enables VLAN Trunking on ports connected to other switches or routers (but not ports directly connected to end users) to allow frames belonging to unknown VLAN groups to pass through the switch.	13
	<code>weight <wt1> <wt2> ... <wt8></code>		A weight value of one to eight is given to each variable from <code>wt 1</code> to <code>wt 8</code> .	13
	<code>wrr</code>		Sets the port(s) to use Weighted Round Robin queuing.	13

42.11.5 interface route-domain Commands

The following table lists the `interface route-domain` commands in configuration mode.

Use these commands to configure the IP routing domains.

Table 108 interface route-domain Commands

COMMAND			DESCRIPTION	PRIVILEGE
<code>interface route-domain <ip-address>/<mask-bits></code>			Enables a routing domain for configuration.	13
	<code>exit</code>		Exits from the interface routing-domain command mode.	13
	<code>ip</code>	<code>dvmrp</code>	Enables this function to permit VLAN groups beyond the local switch.	13
		<code>igmp <v1 v2></code>	Enables IGMP in this routing domain.	13
		<code>igmp robustness-variable <2-255></code>	Sets the igmp robustness variable on the switch. This variable specifies how susceptible the subnet is to lost packets.	13
		<code>igmp query-interval</code>	Sets the igmp query interval on the switch. This variable specifies the amount of time in seconds between general query messages sent by the router.	13
		<code>igmp query-max-response-time <1-25></code>	Sets the maximum time that the router waits for a response to an general query message.	13
		<code>igmp last-member-query-interval <1-25></code>	Sets the amount of time in seconds that the router waits for a response to a group specific query message.	13
		<code>ospf authentication-key <k></code>	Enables OSPF authentication in this routing domain.	13
		<code>ospf authentication-same-as-area</code>	Sets the same OSPF authentication settings in the routing domain as the associated area.	13
		<code>ospf cost <1-65535></code>	Sets the OSPF cost in this routing domain.	13
		<code>ospf message-digest-key <k></code>	Sets the OSPF authentication key in this routing domain.	13
		<code>ospf priority <0-255></code>	Sets the OSPF priority for the interface. Setting this value to 0 means that this router will not participate in router elections.	13

Table 108 interface route-domain Commands (continued)

COMMAND			DESCRIPTION	PRIVILEGE
		rip direction <Outgoing Incoming Both None> version <v1 v2b v2m>	Sets the RIP direction in this routing domain as well as the version number.	13
		vrrp authentication-key <k>	Sets the VRRP authentication key in the routing domain.	13
	no	ip dvmrp	Disables DVMRP in this routing domain.	13
		ip igmp	Disables IP IGMP in this routing domain.	13
		ip ospf authentication-key	Disables OSPF authentication key settings in this routing domain.	13
		ip ospf authentication-sama	Sets the routing domain not to use the same OSPF authentication settings as the area.	13
		ip ospf cost	Disables the OSPF cost in the routing domain.	13
		ip ospf message-digest-key	Sets the routing domain not to use a security key in OSPF.	13
		ip ospf priority	Resets the OSPF priority for the interface.	13
		ip vrrp authentication-key	Resets the VRRP authentication settings.	13

42.11.6 config-vlan Commands

The following table lists the `vlan` commands in configuration mode.

Table 109 Command Summary: config-vlan Commands

COMMAND			DESCRIPTION	PRIVILEGE
vlan <vlan-id>			Creates a new VLAN group.	13
	exit		Leaves the VLAN configuration mode.	13
	fixed <port-list>		Specifies the port(s) to be a permanent member of this VLAN group.	13
	forbidden <port-list>		Specifies the port(s) you want to prohibit from joining this VLAN group.	13
	help		Displays a list of available VLAN commands.	13

Table 109 Command Summary: config-vlan Commands (continued)

COMMAND		DESCRIPTION	PRIVILEGE	
	inactive		Disables the specified VLAN.	13
	ip address	<ip-address> <mask>	Sets the IP address of the switch in the VLAN.	13
		<ip-address> <mask> manageable	Sets the IP address of the switch in the VLAN and allow remote management to this IP address.	13
		default-gateway <ip-address>	Sets the default gateway IP address in this VLAN.	13
	name <name-str>		Specifies a name for identification purposes.	13
	no	fixed <port-list>	Sets fixed port(s) to normal port(s).	13
		forbidden <port-list>	Sets forbidden port(s) to normal port(s).	13
		inactive	Enables the specified VLAN.	13
		ip address <ip-address> <mask>	Deletes the IP address and subnet mask from this VLAN.	13
		ip address default-gateway	Deletes the default gateway from this VLAN.	13
		untagged <port-list>	Specifies the port(s) you want to tag all outgoing frames transmitted with this VLAN Group ID.	13
	normal <port-list>		Specifies the port(s) to dynamically join this VLAN group using GVRP	13
	untagged <port-list>		Specifies the port(s) you don't want to tag all outgoing frames transmitted with this VLAN Group ID.	13

42.12 mvr Commands

The following table lists the `mvr` commands in configuration mode.

Table 110 Command Summary: mvr Commands

COMMAND		DESCRIPTION	PRIVILEGE
mvr <vlan-id>		Enters the MVR (Multicast VLAN Registration) configuration mode.	13
	exit	Exist from the MVR configuration mode.	13

Table 110 Command Summary: mvr Commands (continued)

COMMAND		DESCRIPTION	PRIVILEGE
	group <name-str> start-address <ip> end-address <ip>		Sets the multicast group range for the MVR. 13
	inactive		Disables MVR settings. 13
	mode <dynamic compatible>		Sets the MVR mode (dynamic or compatible). 13
	name <name-str>		Sets the MVR name for identification purposes. 13
	no	group	Disables all MVR group settings. 13
		group <name-str>	Disables the specified MVR group setting. 13
		inactive	Enables MVR. 13
		receiver-port <port-list>	Disables the receiver port(s).An MVR receiver port can only receive multicast traffic in a multicast VLAN. 13
		source-port <port-list>	Disables the source port(s).An MVR source port can send and receive multicast traffic in a multicast VLAN. 13
		tagged <port- list>	Sets the port(s) to untag VLAN tags. 13
	receiver-port <port-list>		Sets the receiver port(s).An MVR receiver port can only receive multicast traffic in a multicast VLAN. 13
	source-port <port-list>		Sets the source port(s).An MVR source port can send and receive multicast traffic in a multicast VLAN. 13
	tagged <port- list>		Sets the port(s) to tag VLAN tags. 13
	8021p-priority		Sets the 802.1p priority for the packets belonging to this VLAN group. 13

CHAPTER 43

User and Enable Mode Commands

This chapter describes some commands which you can perform in the User and Enable modes.

43.1 Overview

The following command examples show how you can use User and Enable modes to diagnose and manage your switch.

43.2 show Commands

These are the commonly used `show` commands.

43.2.1 show system-information

Syntax:

```
show system-information
```

This command shows the general system information (such as the firmware version and system up time).

An example is shown next.

```
sysname# show system-info
System Name           : ES-4124
System Contact        :
System Location       :
Ethernet Address      : 00:13:49:1e:77:9b
ZyNOS F/W Version     : V3.70(LL.0)b4 | 08/16/2006
RomRasSize            : 2750846
System up Time        :      2:39:38 (e9dad ticks)
Bootbase Version      : V3.0 | 04/06/2005
```

43.2.2 show ip

Syntax:

```
show ip
```

This command displays the IP related information (such as IP address and subnet mask) on all switch interfaces.

The following figure shows the default interface settings.

```
sysname> show ip
Out-of-band Management IP Address = 192.168.0.1
Management IP Address
    IP[192.168.0.1], Netmask[255.255.255.0], VID[0]
IP Interface
    IP[192.168.1.1], Netmask[255.255.255.0], VID[1]
sysname>
```

43.2.3 show logging

Syntax:

```
show logging
```

This command displays the system logs. The following figure shows an example.

```
sysname# show logging
 1 Thu Jan  1 00:02:08 1970 PP05 -WARN  SNMP TRAP 3: link up
 2 Thu Jan  1 00:03:14 1970      INFO  adjtime task pause 1 day
 3 Thu Jan  1 00:03:16 1970 PP0f -WARN  SNMP TRAP 26: Event On Trap
 4 Thu Jan  1 00:03:16 1970 PINI -WARN  SNMP TRAP 1: warm start
 5 Thu Jan  1 00:03:16 1970 PINI -WARN  SNMP TRAP 3: link up
 6 Thu Jan  1 00:03:16 1970 PINI  INFO  main: init completed
 7 Thu Jan  1 00:00:13 1970 PP26  INFO  adjtime task pause 1 day
 8 Thu Jan  1 00:00:14 1970 PP0f -WARN  SNMP TRAP 26: Event On Trap
 9 Thu Jan  1 00:00:14 1970 PINI -WARN  SNMP TRAP 0: cold start
10 Thu Jan  1 00:00:14 1970 PINI  INFO  main: init completed
11 Thu Jan  1 00:00:04 1970 PP05 -WARN  SNMP TRAP 3: link up
11 Thu Jan  1 00:00:04 1970 PP05 -WARN  SNMP TRAP 3: link up
Clear Error Log (y/n):
```

Note: If you clear a log (by entering *y* at the Clear Error Log (y/n) :prompt), you cannot view it again.

43.2.4 show interface

Syntax:

```
show interface [port-number]
```

This command displays statistics of a port. The following example shows that port 2 is up and the related information.

```

sysname# show interface 2
Port Info      Port NO.      :2
               Link          :100M/F
               Status       :FORWARDING
               LACP         :Disabled
               TxPkts       :0
               RxPkts       :63
               Errors       :0
               Tx KBs/s     :0.0
               Rx KBs/s     :0.0
               Up Time      :0:02:33
TX Packet      Tx Packets    :0
               Multicast    :0
               Broadcast    :0
               Pause        :0
               Tagged       :0
RX Packet      Rx Packets    :63
               Multicast    :0
               Broadcast    :63
               Pause        :0
               Control      :0
TX Collison    Single        :0
               Multiple     :0
               Excessive    :0
               Late         :0
Error Packet   RX CRC       :0
               Length      :0
               Runt        :0
Distribution   64          :3
               65 to 127   :44
               128 to 255  :14
               256 to 511  :2
               512 to 1023 :0
               1024 to 1518 :0
               Giant       :0
sysname#

```

43.2.5 show mac address-table

Syntax:

```
show mac address-table <all <sort>|static>
```

Where

<sort> = Specifies the sorting criteria (MAC, VID or port).

This command displays the MAC address(es) stored in the switch. The following example shows the static MAC address table.

```
sysname# show mac address-table static
Port      VLAN ID      MAC Address      Type
CPU       1            00:a0:c5:01:23:46  Static
sysname#
```

43.3 ping

Syntax:

```
ping <ip|host-name> < [in-band|out-of-band|vlan <vlan-id> ] [size
-> <0-1472>] [-t]>
```

where

<ip host-name>	=	The IP address or host name of an Ethernet device.
[in-band out-of-band vlan <vlan-id>]	=	Specifies the network interface or the VLAN ID to which the Ethernet device belongs. out-of-band refers to the management port while in-band means the other ports on the switch.
[size <0-1472>]	=	Specifies the packet size to send.
[-t]	=	Sends Ping packets to the Ethernet device indefinitely. Press [CTRL]+ C to terminate the Ping process.

This command sends Ping packets to an Ethernet device. The following example sends Ping requests to and displays the replies from an Ethernet device with an IP address of 192.168.1.100.

```
sysname# ping 192.168.1.100
sent  rcvd  rate    rtt     avg     mdev    max     min  reply from
  1     1    100      0       0       0       0       0    192.168.1.100
  2     2    100      0       0       0       0       0    192.168.1.100
  3     3    100      0       0       0       0       0    192.168.1.100
sysname#
```

43.4 traceroute

Syntax:

```
traceroute <ip|host-name> [in-band|out-of-band|vlan <vlan-id>] [ttl
-> <1-255>] [wait <1-60>] [queries <1-10>]
```

where

- <ip|host-name> = The IP address or host name of an Ethernet device.
- [in-band|out-of-band|vlan <vlan-id>] = Specifies the network interface or the VLAN ID to which the Ethernet device belongs.
- [ttl <1-255>] = Specifies the Time To Live (TTL) period.
- [wait <1-60>] = Specifies the time period to wait.
- [queries <1-10>] = Specifies how many tries the switch performs the traceroute function.

This command displays information about the route to an Ethernet device. The following example displays route information to an Ethernet device with an IP address of 192.168.1.100.

```
sysname> traceroute 192.168.1.100
traceroute to 192.168.1.100, 30 hops max, 40 byte packet
 1:192.168.1.100 (10 ms) (10 ms) (0 ms)
traceroute done:
sysname>
```

43.5 Copy Port Attributes

Use the `copy running-config` command to copy attributes of one port to another port or ports.

Syntax:

```
copy running-config interface port-channel <port> <port-list>
copy running-config interface port-channel <port> <port-list>
-> [active] [name] [speed-duplex] [bpdu-control] [flow-control]
-> [intrusion-lock] [vlanlq] [vlanlq-member] [bandwidth-limit]
-> [vlan-stacking] [port-security] [broadcast-storm-control] [mirroring]
-> [port-access-authenticator] [queuing-method] [igmp-filtering]
-> [spanning-tree] [mrstp] [port-based-vlan]
```

where

```
copy running-config = Copies all of the possible attributes from one port to another port
interface port-      or ports.
channel <port>
<port-list>
copy running-config = Copies only the specified port attributes from one port to another
interface port-      port or ports.
channel <port>
<port-list>
[active... ]
```

An example is shown next.

- Copy all attributes of port 1 to port 2
- Copy selected attributes (active, bandwidth limit and STP settings) to ports 5-8

```
sysname# copy running-config interface port-channel 1 2
sysname# copy running-config interface port-channel 1 5-8 active
bandwidth-limit spanning-tree
```

43.6 Configuration File Maintenance

The following sections show how to manage the configuration files.

43.6.1 Using a Different Configuration File

You can store up to two configuration files on the switch. Only one configuration file is used at a time. By default the switch uses the first configuration file (with an index number of 1). You can set the switch to use a different configuration file. There are two ways in which you can set the switch to use a different configuration file: restart the switch (cold reboot) and restart the system (warm reboot).

Use the `boot config` command to restart the switch and use a different configuration file (if specified). The following example restarts the switch to use the second configuration file.

```
sysname# boot config 2
```

Use the `reload config` command to restart the system and use a different configuration file (if specified). The following example restarts the system to use the second configuration file.

```
sysname# reload config 2
```

Note: When you use the `write memory` command without specifying a configuration file index number, the switch saves the changes to the configuration file the switch is currently using.

43.6.2 Resetting to the Factory Default

Follow the steps below to reset the switch back to the factory defaults.

- 1** Enter `erase running config` to reset the current running configuration.
- 2** Enter `write memory` to save the changes to the current configuration file. If you want to reset the second configuration file, use the `write memory` command again with the specified index number.

The following example resets both configuration files to the factory default settings.

```
sysname# erase running-config
sysname# write memory
sysname# write memory 2
```

CHAPTER 44

Configuration Mode Commands

This chapter describes how to enable and configure your switch's features using commands. For more background information, see the feature specific chapters which proceed the commands chapters.

44.1 Enabling IGMP Snooping

To enable IGMP snooping on the switch. Enter `igmp-snooping` and press [ENTER]. You can also set how to treat traffic from an unknown multicast group by typing the `unknown-multicast-frame` parameter.

Syntax:

```
igmp-snooping
igmp-snooping 8021p-priority <0-7>
igmp-snooping host-timeout <1-16711450>
igmp-snooping leave-timeout <1-16711450>
igmp-snooping unknown-multicast-frame <drop|flooding>
igmp-snooping reserved-multicast-group <drop|flooding>
```

where

<code>igmp-snooping</code>	=	Enables IGMP snooping on the switch.
<code>8021p-priority</code>	=	Sets a priority level (0-7) to which the switch changes the priority in outgoing IGMP control packets.
<code>host-timeout <1-16711450></code>	=	Specifies the time out period of the switch with respect to IGMP report queries. If an IGMP report for a multicast group was not received for a host-timeout period, from a specific port, this port is deleted from the member list of that multicast group.
<code>leave-timeout <1-16711450></code>	=	Specifies the time that the switch will wait for multicast members to respond to a leave report. If no response happens in the timeout period, the switch deletes the port from the multicast group.
<code>unknown-multicast-frame <drop flooding></code>	=	Specifies whether you want to discard packets from unknown multicast groups or whether you want to forward them to all ports.
<code>reserved-multicast-group <drop flooding></code>	=	Specifies whether you want to discard packets in the reserved multicast groups or whether you want to forward them to all ports.

An example is shown next.

- Enable IGMP snooping on the switch.
- Set the `host-timeout` and `leave-timeout` values to 30 seconds
- Set the switch to drop packets from unknown multicast groups.

```
sysname(config)# igmp-snooping
sysname(config)# igmp-snooping host-timeout 30
sysname(config)# igmp-snooping leave-timeout 30
sysname(config)# igmp-snooping unknown-multicast-frame drop
```

44.2 Configure IGMP Filter

Use the following commands in the config mode to configure IGMP filtering profiles.

Syntax:

```
igmp-filtering
igmp-filtering profile <name> start-address <ip> end-address <ip>
```

where

- | | | |
|-----------------------------------|---|---|
| <code>igmp filtering</code> | = | Enables IGMP filtering on the switch |
| <code>profile <name></code> | = | Specifies a name (up to 32 alphanumeric characters) for this IGMP profile. If you want to edit an existing IGMP profile enter the existing profile name followed by <code>start-address</code> and <code>end-address</code> parameters. |
| <code>start-address</code> | = | Specifies the starting multicast IP address for a range of multicast IP addresses that you want to belong to the IGMP filter profile. IP address in the range 224.0.0.0 to 239.255.255.255 are used for IP multicasting. |
| <code>end-address</code> | = | Specifies the ending multicast IP address for a range of multicast IP addresses that you want to belong to the IGMP filter profile. IP address in the range 224.0.0.0 to 239.255.255.255 are used for IP multicasting. |

An example is shown next.

- Enable IGMP filtering on the switch.
- Create an IGMP filtering profile **filter1** and specify the multicast IP addresses in the range **224.255.255.0** to **225.255.255.255** to belong to this profile.

```
sysname(config)# igmp-filtering
sysname(config)# igmp-filtering profile filter1 start-address
224.255.255.0 end-address 225.255.255.255
```

44.3 Enabling STP

Use the `spanning-tree` or the `mrstp` commands to enable and configure STP on the switch. The difference between the commands is that `spanning-tree` only allows you to set up one spanning tree configuration and the `mrstp` command allows you to set up multiple ones.

Syntax:

```
spanning-tree
spanning-tree priority <0-61440>
spanning-tree hello-time <1-10> maximum-age <6-40> forward-delay <4-30>
spanning-tree <port-list> path-cost <1-65535>
spanning-tree <port-list> priority <0-255>
```

and

```
mrstp <treeIndex> <cr>
mrstp <treeIndex> priority <0-61440>
mrstp <treeIndex> hello-time <1-10> maximum-age <6-40> forward-delay
-> <4-30>
mrstp interface <port-list> <cr>
mrstp interface <port-list> path-cost <1-65535>
mrstp interface <port-list> priority <0-255>
mrstp interface <port-list> treeIndex <1-4>
```

where

<code>spanning-tree</code>	=	Enables STP on the switch.
<code>mrstp <treeIndex></code>	=	Enables a specific tree configuration.
<code>priority <0-61440></code>	=	Specifies the bridge priority for the switch. The lower the numeric value you assign, the higher the priority for this bridge.

Bridge priority is used in determining the root switch, root port and designated port. The switch with the highest priority (lowest numeric value) becomes the STP root switch. If all switches have the same priority, the switch with the lowest MAC address will then become the root switch.

<code>hello-time <1-10></code>	=	Specifies the time interval in seconds between BPDU (Bridge Protocol Data Units) configuration message generations by the root switch.
--------------------------------------	---	--

Bridge Priority determines the root bridge, which in turn determines Hello Time, Max Age and Forwarding Delay.

- `maximum-age <6-40>` = Specifies the maximum time (in seconds) a switch can wait without receiving a BPDU before attempting to reconfigure. All switch ports (except for designated ports) should receive BPDUs at regular intervals. Any port that ages out STP information (provided in the last BPDU) becomes the designated port for the attached LAN. If it is a root port, a new root port is selected from among the switch ports attached to the network.
- `forward-delay <4-30>` = Specifies the maximum time (in seconds) a switch will wait before changing states. This delay is required because every switch must receive information about topology changes before it starts to forward frames. In addition, each port needs time to listen for conflicting information that would make it return to a blocking state; otherwise, temporary data loops might result.
- `<port-list> path-cost <1-65535>` = Enables STP on the specified ports.
Specifies the cost of transmitting a frame on to a LAN through that port. It is assigned according to the speed of the bridge.
- `<port-list> priority <0-255>` = Specifies the priority for each port.
Priority decides which port should be disabled when more than one port forms a loop in a switch. Ports with a higher priority numeric value are disabled first.
- `<port-list> treeIndex <1-4>` = Specifies which STP configuration these ports will participate in. (mrstp command only).

An example using `spanning-tree` command is shown next.

- Enable STP on the switch.
- Set the bridge priority of the switch to 0.
- Set the Hello Time to 4, Maximum Age to 20 and Forward Delay to 15 on the switch.
- Enable STP on port 5 with a path cost of 150.
- Set the priority for port 5 to 20.

```
sysname(config)# spanning-tree priority 0
sysname(config)# spanning-tree hello-time 4 maximum-age 20 forward-delay
15
sysname(config)# spanning-tree 5 path-cost 150
sysname(config)# spanning-tree 5 priority 20
```

44.4 no Command Examples

These are the commonly used command examples that belong to the `no` group of commands. The `no` group commands are commands which are preceded by keyword `no`. This command negates the intended action of the command. In most cases the `no` command disables, resets or clears settings. There are cases, however, where the `no` command can activate features. This section shows some uses of these commands.

44.4.1 Disable Commands

Use the `no` command to disable features on the switch.

Syntax:

```
no spanning-tree
no mirror-port
```

Disables STP on the switch.

Disables port mirroring on the switch.

44.4.2 Resetting Commands

Use the `no` command to reset switch settings to their default values.

Syntax:

```
no https timeout
```

Resets the https session timeout to default.

An example is shown next. The session timeout is reset to 300 seconds.

```
sysname(config)# no https timeout
Cache timeout 300
```

44.4.3 Re-enable commands

The `no` command can also be used to re-enable features which have been disabled.

Syntax:

```
no ip route <ip> <mask> inactive
```

where

<ip> <mask> inactive = Re-enables an ip route with the specified IP address and subnet mask.

An example is shown next.

- Enable the IP route with the IP address of 192.168.11.1 and subnet mask of 255.255.255.0. This ip route must have already been created and made inactive prior to re-enable command being applied.

```
sysname(config)# no ip route 192.168.11.1 255.255.255.0 inactive
```

44.4.4 Other Examples of no Commands

In some cases the `no` command can disable a feature, disable an option of a feature or disable a feature on a port by port basis.

44.4.4.1 no trunk

Syntax:

```
no trunk <T1|T2|T3|T4|T5|T6>
no trunk <T1|T2|T3|T4|T5|T6> lacp
no trunk <T1|T2|T3|T4|T5|T6> interface <port-list>
```

where

<T1|T2|T3|T4|T5|T6> = Disables the trunk group.
<T1|T2|T3|T4|T5|T6> lacp = Disables LACP in the trunk group.
<T1|T2|T3|T4|T5|T6> interface <port-list> = Removes ports from the trunk group.

An example is shown next.

- Disable trunk one (T1).
- Disable LACP on trunk three (T3).
- Remove ports one, three, four and five from trunk two (T2).

```
sysname(config)# no trunk T1
sysname(config)# no trunk T3 lacp
sysname(config)# no trunk T2 interface 1,3-5
```

44.4.4.2 no port-access-authenticator

Syntax:

```
no port-access-authenticator
no port-access-authenticator <port-list> reauthenticate
no port-access-authenticator <port-list>
```

where

	=	Disables port authentication on the switch.
<port-list> reauthenticate	=	Disables the re-authentication mechanism on the listed port(s).
<port-list>	=	Disables authentication on the listed ports.

An example is shown next.

- Disable authentication on the switch.
- Disable re-authentication on ports one, three, four and five.
- Disable authentication on ports one, six and seven.

Figure 155 no port-access-authenticator Command Example

```
sysname(config)# no port-access-authenticator
sysname(config)# no port-access-authenticator 1,3-5 reauthenticate
sysname(config)# no port-access-authenticator 1,6-7
```

44.4.4.3 no ssh

Syntax:

```
no ssh key <rsa1|rsa|dsa>
no ssh known-hosts <host-ip>
no ssh known-hosts <host-ip> [1024|ssh-rsa|ssh-dsa]
```

where

key <rsa1 rsa dsa>	=	Disables the secure shell server encryption key. Your switch supports SSH versions 1 and 2 using RSA and DSA authentication.
known-hosts <host-ip>	=	Removes a specific remote host from the list of all known hosts.
known-hosts <host-ip> [1024 ssh-rsa ssh-dsa]	=	Removes remote known hosts with a specified public key type (1024-bit RSA1, RSA or DSA).

An example is shown next.

- Disable the secure shell RSA1 encryption key.
- Remove the remote host with IP address 172.165.1.8 from the list of known hosts.
- Remove the remote host with IP address 172.165.1.9 and with an SSH-RSA encryption key from the list of known hosts.

```
sysname(config)# no ssh key rsa1
sysname(config)# no ssh known-hosts 172.165.1.8
sysname(config)# no ssh known-hosts 172.165.1.9 ssh-rsa
```

44.5 Static Route Commands

You can create and configure static routes on the switch by using the `ip route` command.

Syntax:

```
ip route <ip> <mask> <next-hop-ip>
ip route <ip> <mask> <next-hop-ip> [metric <metric>][name <name>]
--> [inactive]
```

where

<ip>	=	Specifies the network IP address of the final destination.
<mask>	=	Specifies the subnet mask of this destination.
<next-hop-ip>	=	Specifies the IP address of the gateway. The gateway is an immediate neighbor of your switch that will forward the packet to the destination. The gateway must be a router on the same segment as your switch.
[metric <metric>]	=	The metric represents the “cost” of transmission for routing purposes. IP routing uses hop count as the measurement of cost, with a minimum of 1 for directly connected networks. Enter a number that approximates the cost for this link. The number need not be precise, but it must be between 1 and 15. In practice, 2 or 3 is usually a good number.
[name <name>]	=	Specifies a descriptive name (up to 32 printable ASCII characters) for identification purposes.
[inactive]	=	Deactivates a static route

An example is shown next.

- Create a static route with the destination IP address of 172.21.1.104, subnet mask of 255.255.0.0 and the gateway IP address of 192.168.1.2.
- Assigns a metric value of 2 to the static route.

- Assigns the name “route1” to the static route.

```
sysname(config)# ip route 172.21.1.104 255.255.0.0 192.168.1.2
sysname(config)# ip route 172.21.1.104 255.255.0.0 192.168.1.2 metric 2
sysname(config)# ip route 172.21.1.104 255.255.0.0 192.168.1.2 name route1
```

44.6 Enabling MAC Filtering

You can create a filter to drop packets based on the MAC address of the source or the destination.

Syntax:

```
mac-filter name <name> mac <mac-addr> vlan <vlan-id> drop <src/dst/both>
```

where

name <name>	=	Names the filtering rule.
mac <mac-addr>	=	Specifies the MAC address you want to filter.
vlan <vlan-id>	=	Specifies which VLAN this rule applies to.
drop <src/dst/both>	=	Selects the behavior of the rule.

- src - drop packets coming from the specified MAC address
- dst- drop packets going to the specified MAC address
- both - drop packets coming from or going to the specified MAC address

An example is shown next.

- Create a filtering rule called “filter1”.
- Drop packets coming from and going to MAC address 00:12:00:12:00:12 on VLAN.

```
sysname(config)# mac-filter name filter 1
sysname(config)# mac-filter name filter 1 mac 00:12:00:12:00:12 vlan 1 drop both
```

44.7 Enabling Trunking

To create and enable a trunk, enter `trunk` followed by the ports which you want to group and press [ENTER].

Syntax:

```
trunk <T1|T2|T3|T4|T5|T6>
trunk <T1|T2|T3|T4|T5|T6> interface <port-list>
trunk <T1|T2|T3|T4|T5|T6> lacp
```

where

<code><T1 T2 T3 T4 T5 T6></code>	=	Enables the trunk.
<code><T1 T2 T3 T4 T5 T6></code> <code>interface <port-list></code>	=	Places ports in the trunk.
<code><T1 T2 T3 T4 T5 T6> lacp</code>	=	Enables LACP in the trunk.

An example is shown next.

- Create trunk 1 on the switch.
- Place ports 5-8 in trunk 1.
- Enable dynamic link aggregation (LACP) on trunk 1.

```
sysname(config)# trunk t1
sysname(config)# trunk t1 interface 5-8
sysname(config)# trunk t1 lacp
```

44.8 Enabling Port Authentication

To enable a port authentication, you need to specify your RADIUS server details and select the ports which require external authentication. You can set up multiple RADIUS servers and specify how the switch will process authentication requests.

44.8.1 RADIUS Server Settings

Configuring multiple RADIUS servers is only available via the command interpreter mode. Use the `radius-server` command to set up your RADIUS server settings.

Syntax:

```
radius-server host <index> <ip>
radius-server host <index> <ip> [acct-port <socket-number>] [key
--> <key-string>]
radius-server timeout <1-1000>
radius-server mode <priority|round-robin>
```

where

<code>radius-server host <index> <ip></code>	=	Specifies the IP address of the RADIUS server.
<code>[acct-port <socket-number>]</code>	=	Changes the UDP port of the RADIUS server from the default (1812).
<code>[key <key-string>]</code>	=	Specifies a password (up to 32 alphanumeric characters) as the key to be shared between the RADIUS server and the switch.
<code>radius-server timeout <1-1000></code>	=	Specifies the timeout period (in seconds) the switch will wait for a response from a RADIUS server. If 2 RADIUS servers are configured, this is the total time the switch will wait for a response from either server.
<code>mode <priority round-robin></code>	=	Specifies the way the switch will process requests from the clients to the RADIUS server. (Only applicable with multiple RADIUS servers configured.)

`priority` - When a client sends an authentication request through the switch to the RADIUS server. The switch will forward the request to the RADIUS server. If no response within half the timeout period, it will forward the request to the second RADIUS server.

`round-robin` - When a client sends an authentication request through the switch to the RADIUS server. The switch will forward the request to the first RADIUS server. If there is no response within the timeout period, the request times out. The client sends an authentication request again and the switch forwards the request to the second RADIUS server.

See [Section 44.8.2 on page 309](#) for an example.

44.8.2 Port Authentication Settings

Use the `port-access-authenticator` command to configure port security on the switch.

Syntax:

```
port-access-authenticator
port-access-authenticator <port-list>
port-access-authenticator <port-list> reauthenticate
port-access-authenticator <port-list> reauth-period <reauth-period>
```

where

<code>port-access-authenticator</code>	=	Enables port authentication on the switch.
<code>port-access-authenticator <port-list></code>	=	Specifies which ports require authentication.
<code>reauthenticate</code>	=	Enables reauthentication on the port.
<code>reauth-period <reauth-period></code>	=	Specifies how often a client has to re-enter his or her username and password to stay connected to the port.

An example is shown next.

- Specify RADIUS server 1 with IP address 10.10.10.1, port 1890 and the string `secretKey` as the password. See [Section 44.8.1 on page 308](#) for more information on RADIUS server commands.
- Specify the timeout period of 30 seconds that the switch will wait for a response from the RADIUS server.
- Enable port authentication on ports 4 to 8.
- Activate reauthentication on the ports.
- Specify 1800 seconds as the interval for client reauthentication.

```
sysname(config)# radius-server host 1 10.10.10.1 acct-port 1890 key
--> secretKey
sysname(config)# radius-server timeout 30
sysname(config)# port-access-authenticator
sysname(config)# port-access-authenticator 4-8
sysname(config)# port-access-authenticator 4-8 reauthenticate
sysname(config)# port-access-authenticator 4-8 reauth-period 1800
```

CHAPTER 45

Interface Commands

These are some commonly used configuration commands that belong to the `interface` group of commands.

45.1 Overview

The interface commands allow you to configure the switch on a port by port basis.

45.2 Interface Command Examples

This section provides examples of some frequently used interface commands.

45.2.1 interface port-channel

Use this command to enable the specified ports for configuration. Indicate multiple, non-sequential ports separated by a comma. Use a dash to specify a port range.

Syntax:

```
interface port-channel <port-list>
```

An example is shown next.

- Enter the configuration mode.
- Enable ports 1, 3, 4 and 5 for configuration.
- Begin configuring for those ports.

```
sysname# config
sysname(config)# interface port-channel 1,3-5
sysname(config-interface)#
```

45.2.2 bpdu-control

Syntax:

```
bpdu-control <peer|tunnel|discard|network>
```

where

`<peer|tunnel|discard|network>` = Type `peer` to process any BPDUs received on these ports.
Type `tunnel` to forward BPDUs received on these ports.
Type `discard` to drop any BPDUs received on these ports.
Type `network` to process a BPDU with no VLAN tag and forward a tagged BPDU.

An example is shown next.

- Enable ports 1, 3, 4 and 5 for configuration.
- Set the BPDU control to `tunnel`, to forward BPDUs received on ports one, three, four and five.

```
sysname(config)# interface port-channel 1,3-5
sysname(config-interface)# bpdu-control tunnel
sysname(config-interface)#
```

45.2.3 broadcast-limit

Syntax:

```
broadcast-limit
broadcast-limit <pkt/s>
```

where

= Enables broadcast storm control limit on the switch.
`<pkt/s>` = Limits how many broadcast packet the interface receives per second.

An example is shown next.

- Enable port one for configuration.
- Enable broadcast control.
- Set how many broadband packets the interface receives per second.

```
sysname(config)# interface port-channel 1
sysname(config-interface)# broadcast-limit
sysname(config-interface)# broadcast-limit 21
```

45.2.4 bandwidth-limit

The `bandwidth-limit` command enables bandwidth control on the switch.

Syntax:

```

bandwidth-limit
bandwidth-limit pir <Kbps>
bandwidth-limit cir <Kbps>
bandwidth-limit egress <Kbps>

```

where

pir <Kbps> = Sets the maximum bandwidth allowed for incoming traffic.

cir <Kbps> = Sets the guaranteed bandwidth allowed for incoming traffic.

egress <Kbps> = Sets the maximum bandwidth allowed for outgoing traffic (egress) on the switch.

An example is shown next.

- Enable port one for configuration.
- Enable bandwidth control.
- Set the outgoing traffic bandwidth limit to 5000Kbps.
- Set the guaranteed bandwidth allowed for incoming traffic to 4000Kbps.
- Set the maximum bandwidth allowed for incoming traffic to 8000Kbps.

```

sysname(config)# interface port-channel 1
sysname(config-interface)# bandwidth-limit
sysname(config-interface)# bandwidth-limit egress 5000
sysname(config-interface)# bandwidth-limit cir 4000
sysname(config-interface)# bandwidth-limit pir 8000

```

45.2.5 mirror

The `mirror` command enables port mirroring on the interface.

Syntax:

```

mirror
mirror dir <ingress|egress|both>

```

where

dir <ingress|egress|both> = Enables port mirroring for incoming, outgoing or both incoming and outgoing traffic.

Port mirroring copies traffic from one or all ports to another or all ports for external analysis.

An example is shown next.

- Enable port mirroring.
- Enable the monitor port 3.
- Enable ports 1, 4, 5 and 6 for configuration.
- Enable port mirroring on the ports.
- Enable port mirroring for outgoing traffic. Traffic is copied from ports 1, 4, 5 and 6 to port three in order to examine it in more detail without interfering with the traffic flow on the original ports.

```
sysname(config)# mirror-port
sysname(config)# mirror-port 3
sysname(config)# interface port-channel 1,4-6
sysname(config-interface)# mirror
sysname(config-interface)# mirror dir egress
```

45.2.6 gvrp

Syntax:

```
gvrp
```

GVRP (GARP VLAN Registration Protocol) is a registration protocol that defines a way for switches to register necessary VLAN members on ports across the network. Enable this function to permit VLAN groups beyond the local switch.

An example is shown next.

- Enable the IEEE 802.1Q tagged VLAN command to configure tagged VLAN for the switch.
- Enable ports one, three, four and five for configuration.
- Enable GVRP on the interface.

```
sysname(config)# vlan1q gvrp
sysname(config)# interface port-channel 1,3-5
sysname(config-interface)# gvrp
```

45.2.7 ingress-check

The `ingress-check` command enables the device to discard incoming frames for VLANs that do not have this port as a member.

Syntax:

```
ingress-check
```

An example is shown next.

- Enable ports 1, 3, 4 and 5 for configuration.

- Enable ingress checking on the interface.

```
sysname(config)# interface port-channel 1,3-5
sysname(config-interface)# ingress-check
```

45.2.8 frame-type

Syntax:

```
frame-type <all|tagged|untagged>
```

where

<all|tagged|untagged> = Choose to accept both tagged and untagged incoming frames, just tagged incoming frames or just untagged incoming frames on a port.

An example is shown next.

- Enable ports one, three, four and five for configuration.
- Enable ingress checking on the ports.
- Enable tagged frame-types on the interface.

```
sysname(config)# interface port-channel 1,3-5
sysname(config-interface)# ingress-check
sysname(config-interface)# frame-type tagged
```

45.2.9 weight

Syntax:

```
weight <wt1> <wt2> ... <wt8>
```

where

<wt1> <wt2> ... = Sets the interface WFQ weighting. A weight value of one to eight is given to each variable from wt 1 to wt 8.

An example is shown next.

- Enable WRR queuing on ports 2 and 6 to 8.
- Enable port 2 and ports 6 to 8 for configuration.

- Set the queue weights from Q0 to Q7.

```
sysname# configure
sysname(config)# interface port-channel 2,6-8
sysname(config-interface)# wrp
sysname(config-interface)# weight 8 7 6 5 4 3 2 1
```

45.2.10 egress set

Syntax:

```
egress set <port-list>
```

where

<port-list> = Sets the outgoing traffic port list for a port-based VLAN.

An example is shown next.

- Enable port-based VLAN tagging on the switch.
- Enable ports one, three, four and five for configuration.
- Set the outgoing traffic ports as the CPU (0), seven (7) and eight (8).

```
sysname(config)# vlan-type port-based
sysname(config)# interface port-channel 1,3-5
sysname(config-interface)# egress set 0,7,8
```

45.2.11 qos priority

Syntax:

```
qos priority <0 .. 7>
```

where

<0 .. 7> = Sets the quality of service priority for a port.

An example is shown next.

- Enable ports one, three, four and five for configuration.
- Set the IEEE 802.1p quality of service priority as four (4).

```
sysname(config)# interface port-channel 1,3-5
sysname(config-interface)# qos priority 4
```

45.2.12 name

Syntax:

```
name <port-name-string>
```

where

<port-name-string> = Sets a name for your port interface.

An example is shown next.

- Enable port one for configuration.
- Set a name for the port.

```
sysname(config)# interface port-channel 1
sysname(config-interface)# name Test
```

45.2.13 speed-duplex

Syntax:

```
speed-duplex <auto|10-half|10-full|100-half|100-full|1000-full>
```

where

<auto|10-half|10-full|100-half|100-full|1000-full> = Sets the duplex mode (half or full) and speed (10, 100 or 1000 Mbps) of the connection on the port. Selecting auto (auto-negotiation) makes one port able to negotiate with a peer automatically to obtain the connection speed and duplex mode that both ends support.

An example is shown next.

- Enable ports one, three, four and five for configuration.
- Set the speed to 100 Mbps in half duplex mode.

```
sysname(config)# interface port-channel 1,3-5
sysname(config-interface)# speed-duplex 100-half
```

45.2.14 test

You can perform an interface loopback test on specified ports. The test returns `Passed!` or `Failed!`

An example is shown next.

- Select ports 3-6 for internal loopback test.
- Execute the test command.
- View the results.

```
sysname(config)# interface port-channel 3-6
sysname(config-interface)# test 3-6
Testing internal loopback on port 3 :Passed!
  Ethernet Port 3 Test ok.
Testing internal loopback on port 4 :Passed!
  Ethernet Port 4 Test ok.
Testing internal loopback on port 5 :Passed!
  Ethernet Port 5 Test ok.
Testing internal loopback on port 6 :Passed!
  Ethernet Port 6 Test ok.
```

45.3 Interface no Command Examples

Similar to the no commands in the Enable and Config modes, the no commands for the Interface sub mode also disable certain features. In this mode, however, this takes place on a port by port basis.

45.3.1 no bandwidth-limit

You can disable bandwidth limit on port 1 simply by placing the no command in front of the bandwidth-limit command.

Syntax:

```
no bandwidth-limit
```

An example is shown next:

- Disable bandwidth limit on port1

```
sysname(config)# interface port-channel 1
sysname(config-interface)# no bandwidth-limit
```

CHAPTER 46

IEEE 802.1Q Tagged VLAN Commands

This chapter describes the IEEE 802.1Q Tagged VLAN and associated commands.

46.1 Configuring Tagged VLAN

The following procedure shows you how to configure tagged VLAN.

- 1 Use the IEEE 802.1Q tagged VLAN commands to configure tagged VLAN for the switch.
 - Use the `vlan <vlan-id>` command to configure or create a VLAN on the switch. The switch automatically enters the `config-vlan` mode. Use the `inactive` command to deactivate the VLAN(s).
 - Use the `interface port-channel <port-list>` command to enter the config-interface mode to set the VLAN settings on a port, then use the `pvid <vlan-id>` command to set the VLAN ID you created for the port-list to that specific port in the PVID table.
 - Use the `exit` command when you are finished configuring the VLAN.

```
sysname (config)# vlan 2000
sysname (config-vlan)# name up1
sysname (config-vlan)# fixed 5-8
sysname (config-vlan)# no untagged 5-8
sysname (config-vlan)# exit
sysname (config)# interface port-channel 5-8
sysname (config-interface)# pvid 2000
sysname (config-interface)# exit
```

- 2 Configure your management VLAN.

- Use the `vlan <vlan-id>` command to create a VLAN (VID 3 in this example) for managing the switch, and the switch will activate the new management VLAN.
- Use the `inactive` command to disable the new management VLAN.

```
sysname (config)# vlan 3
sysname (config-vlan)# inactive
```

46.2 Global VLAN1Q Tagged VLAN Configuration Commands

This section shows you how to configure and monitor the IEEE 802.1Q Tagged VLAN.

46.2.1 GARP Status

Syntax:

```
show garp
```

This command shows the switch's GARP timer settings, including the join, leave and leave all timers.

An example is shown next.

```
sysname# show garp
GARP Timer
-----
Join Timer = 200
Leave Timer = 600
Leave All Timer = 10000
sysname#
```

46.2.2 GARP Timer

Syntax:

```
garp join <msec> leave <msec> leaveall <msec>
```

where

- `join <msec>` = This sets the duration of the Join Period timer for GVRP in milliseconds. Each port has a Join Period timer. The allowed Join Time range is between 100 and 32767 milliseconds; the default is 200 milliseconds.
- `leave <msec>` = This sets the duration of the Leave Period timer for GVRP in milliseconds. Each port has a single Leave Period timer. Leave Time must be two times larger than Join Timer; the default is 600 milliseconds.
- `leaveall <msec>` = This sets the duration of the Leave All Period timer for GVRP in milliseconds. Each port has a single Leave All Period timer. Leave All Timer must be larger than Leave Timer; the default is 10000 milliseconds.

This command sets the switch's GARP timer settings, including the join, leave and leave all timers.

Switches join VLANs by making a declaration. A declaration is made by issuing a Join message using GARP. Declarations are withdrawn by issuing a Leave message. A Leave All message terminates all registrations. GARP timers set declaration timeout values.

The following example sets the Join Timer to 300 milliseconds, the Leave Timer to 800 milliseconds and the Leave All Timer to 11000 milliseconds.

```
sysname (config)# garp join 300 leave 800 leaveall 11000
```

46.2.3 GVRP Timer

Syntax:

```
show vlan1q gvrp
```

This command shows the switch's GVRP settings.

An example is shown next.

```
sysname# show vlan1q gvrp
GVRP Support
-----
gvrpEnable = YES
sysname #
```

46.2.4 Enable GVRP

Syntax:

```
vlan1q gvrp
```

This command turns on GVRP in order to propagate VLAN information beyond the switch.

46.2.5 Disable GVRP

Syntax:

```
no vlan1q gvrp
```

This command turns off GVRP so that the switch does not propagate VLAN information to other switches.

46.3 Port VLAN Commands

You must configure the switch port VLAN settings in config-interface mode.

46.3.1 Set Port VID

Syntax:

```
pvid <VID>
```

where

<VID> = Specifies the VLAN number between 1 and 4094.

This command sets the default VLAN ID on the port(s).

The following example sets the default VID to 200 on ports 1 to 5.

```
sysname (config)# interface port-channel 1-5
sysname (config-interface)# pvid 200
```

46.3.2 Set Acceptable Frame Type

Syntax:

```
frame-type <all|tagged|untagged>
```

where

<all|tagged|untagged> = Specifies all Ethernet frames (tagged and untagged), only tagged Ethernet frames or only untagged Ethernet frames.

This command sets the specified port to accept all Ethernet frames or only those with an IEEE 802.1Q VLAN tag.

The following example sets ports 1 to 5 to accept only tagged frames.

```
sysname (config)# interface port-channel 1-5
sysname (config-interface)# frame-type tagged
```

46.3.3 Enable or Disable Port GVRP

Use the `gvrp` command to enable GVRP on the port(s). Use the `no gvrp` command to disable GVRP.

The following example turns off GVRP for ports 1 to 5.

```
sysname (config)# interface port-channel 1-5
sysname (config-interface)# no gvrp
```

46.3.4 Modify Static VLAN

Use the following commands in the config-vlan mode to configure the static VLAN table.

Syntax:

```
vlan <vlan-id>
fixed <port-list>
forbidden <port-list>
name <name-str>
normal <port-list>
untagged <port-list>
no fixed <port-list>
no forbidden <port-list>
no untagged <port-list>
```

where

<vlan-id> = The VLAN ID [1 – 4094].
 <name-str> = A name to identify the SVLAN entry.
 <port-list> = This is the switch port list.

- Enter `fixed` to register the <port-list> to the static VLAN table with <vlan-id>.
- Enter `normal` to confirm registration of the <port-list> to the static VLAN table with <vlan-id>.
- Enter `forbidden` to block a <port-list> from joining the static VLAN table with <vlan-id>.
- Enter `no fixed` or `no forbidden` to change <port-list> to normal status.
- Enter `untagged` to send outgoing frames without a tag.
- Enter `no untagged` to tag outgoing frames.

46.3.4.1 Modify a Static VLAN Table Example

The following example configures ports 1 to 5 as fixed and untagged ports in VLAN 2000.

```
sysname (config)# vlan 2000
sysname (config-vlan)# fixed 1-5
sysname (config-vlan)# untagged 1-5
```

46.3.4.2 Forwarding Process Example

46.3.4.2.1 Tagged Frames

- 1 First the switch checks the VLAN ID (VID) of tagged frames or assigns temporary VIDs to untagged frames.
- 2 The switch then checks the VID in a frame's tag against the SVLAN table.

- 3 The switch notes what the SVLAN table says (that is, the SVLAN tells the switch whether or not to forward a frame and if the forwarded frames should have tags).
- 4 Then the switch applies the port filter to finish the forwarding decision. This means that frames may be dropped even if the SVLAN says to forward them. Frames might also be dropped if they are sent to a CPE (customer premises equipment) DSL device that does not accept tagged frames.

46.3.4.2.2 Untagged Frames

- 1 An untagged frame comes in from the LAN.
- 2 The switch checks the PVID table and assigns a temporary VID of 1.
- 3 The switch ignores the port from which the frame came, because the switch does not send a frame to the port from which it came. The switch also does not forward frames to “forbidden” ports.
- 4 If after looking at the SVLAN, the switch does not have any ports to which it will send the frame, it won't check the port filter.

46.3.5 Delete VLAN ID

Syntax:

```
no vlan <vlan-id>
```

where

<vlan-id> = The VLAN ID [1 – 4094].

This command deletes the specified VLAN ID entry from the static VLAN table. The following example deletes entry 2 in the static VLAN table.

```
sysname (config)# no vlan 2
```

46.4 Enable VLAN

Syntax:

```
vlan <vlan-id>
```

This command enables the specified VLAN ID in the SVLAN (Static VLAN) table.

46.5 Disable VLAN

Syntax:

```
vlan <vlan-id> inactive
```

This command disables the specified VLAN ID in the SVLAN (Static VLAN) table.

46.6 Show VLAN Setting

Syntax:

```
show vlan
```

This command shows the IEEE 802.1Q Tagged SVLAN (Static VLAN) table.

An example is shown next.

- VID is the VLAN identification number.
- Status shows whether the VLAN is static or active.
- Elap-Time is the time since the VLAN was created on the switch.
- The TagCtl section of the last column shows which ports are tagged and which are untagged.

```
sysname# show vlan
The Number of VLAN: 3
Idx. VID  Status  Elap-Time  TagCtl
-----
1   1   Static  0:12:13   Untagged :1-2
                        Tagged   :
1  100  Static  0:00:17   Untagged :
                        Tagged   :1-4
1  200  Static  0:00:07   Untagged :1-2
                        Tagged   :3-8
```

CHAPTER 47

Multicast VLAN Registration Commands

This chapter shows you how to use Multicast VLAN Registration (mvr) commands.

47.1 Overview

Use the mvr commands in the configuration mode to create and configure multicast VLANs.

Note: If you want to enable IGMP snooping see [Section 44.1 on page 299](#).

47.2 Create Multicast VLAN

Use the following commands in the config-mvr mode to configure a multicast VLAN group.

Syntax:

```
mvr <vlan-id>
mvr <vlan-id> source-port <port-list>
mvr <vlan-id> receiver-port <port-list>
mvr <vlan-id> inactive
mvr <vlan-id> mode <dynamic|compatible>
mvr <vlan-id> name <name-str>
mvr <vlan-id> tagged <port-list>
mvr <vlan-id> group <name-str> start-address <ip> end-address <ip>
mvr <vlan-id> exit
```

where

<vlan-id>	=	The VLAN ID [1 – 4094].
source-port <port-list>	=	Specifies the MVR source ports which send and receive multicast traffic.
receiver-port <port-list>	=	Specifies the MVR receiving ports which only receive multicast traffic.
name <name-str>	=	A name to identify the multicast VLAN group.
mode <dynamic compatible>	=	Specifies dynamic (sends IGMP reports to all source ports in the multicast VLAN) or compatible (does not send IGMP reports).

`group name` = A name to identify the MVR IP multicast group.
`<name-str>`

`start-address` = Specifies the starting IP multicast address of the multicast group in dotted decimal notation.
`<ip>`

`end-address <ip>` = Specifies the ending IP multicast address of the multicast group in dotted decimal notation. Enter the same IP address as the start-address if you want to configure only one IP address for the multicast group.

- Enter MVR mode. Create a multicast VLAN with the name `multivlan` and the VLAN ID of 3.
- Specify source ports 2, 3, 5 and receiver ports 6-8.
- Specify dynamic mode for the multicast group.
- Configure MVR multicast group addresses by the name of `ipgroup`.
- Exit MVR mode.

See the following example.

```
sysname(config)# mvr 3 name multivlan
sysname(config-mvr)# source-port 2,3,5 receiver-port 6-8
sysname(config-mvr)# mode dynamic
sysname(config-mvr)# group ipgroup start-address 224.0.0.1 end-address
--> 224.0.0.255
sysname(config-mvr)# exit
```

CHAPTER 48

Routing Domain Command Examples

48.0.1 interface route-domain

Syntax:

```
interface route-domain <ip-address>/<mask-bits>
```

where

- <ip-address> = This is the IP address of the switch in the routing domain. Specify the IP address in dotted decimal notation. For example, 192.168.1.1.
- <mask-bits> = The number of bits in the subnet mask. Enter the subnet mask number preceded with a "/". To find the bit number, convert the subnet mask to binary and add all of the 1's together. Take "255.255.255.0" for example. 255 converts to eight 1's in binary. There are three 255's, so add three eights together and you get the bit number (24).

Use this command to enable/create the specified routing domain for configuration.

An example is shown next.

- Enter the configuration mode.
- Enable default routing domain (the 192.168.1.1 subnet) for configuration.
- Begin configuring for this domain.

```
sysname# config
sysname(config)# interface route-domain 192.168.1.1/24
cmd interface route domain
  192.168.1.1 255.255.255.0
sysname(config-if)#
```

CHAPTER 49

Troubleshooting

This chapter covers potential problems and possible remedies.

49.1 Problems Starting Up the Switch

Table 111 Troubleshooting the Start-Up of Your Switch

PROBLEM	CORRECTIVE ACTION
None of the LEDs turn on when you turn on the switch.	Check the power connection and make sure the power source is turned on. If the error persists, you may have a hardware problem. In this case, you should contact your vendor.

49.2 Problems Accessing the Switch

Table 112 Troubleshooting Accessing the Switch

PROBLEM	CORRECTIVE ACTION
I cannot access the switch using Telnet.	Make sure the ports are properly connected. You may have exceeded the maximum number of concurrent Telnet sessions. Close other Telnet session(s) or try connecting again later. Check that you have enabled Telnet service access. If you have configured a secured client IP address, your computer's IP address must match it. Refer to the chapter on access control for details.
I cannot access the web configurator.	The administrator username is "admin". The default administrator password is "1234". The username and password are case-sensitive. Make sure that you enter the correct password and username using the proper casing. If you have changed the password and have now forgotten it, you will need to upload the default configuration file. This restores all of the factory defaults including the password. If you have configured more than one IP interface, make sure another administrator is NOT logged into the web configurator on a different IP interface using the same account. Check that you have enabled web service access. If you have configured a secured client IP address, your computer's IP address must match it. Refer to the chapter on access control for details. Your computer's and the switch's IP addresses must be on the same subnet. See the following section to check that pop-up windows, JavaScripts and Java permissions are allowed.

49.2.1 Pop-up Windows, JavaScripts and Java Permissions

In order to use the web configurator you need to allow:

- Web browser pop-up windows from your device.
- JavaScripts (enabled by default).
- Java permissions (enabled by default).

Note: Internet Explorer 6 screens are used here. Screens for other Internet Explorer versions may vary.

49.2.1.1 Internet Explorer Pop-up Blockers

You may have to disable pop-up blocking to log into your device.

Either disable pop-up blocking (enabled by default in Windows XP SP (Service Pack) 2) or allow pop-up blocking and create an exception for your device's IP address.

49.2.1.1.1 Disable pop-up Blockers

- 1 In Internet Explorer, select **Tools, Pop-up Blocker** and then select **Turn Off Pop-up Blocker**.

Figure 156 Pop-up Blocker

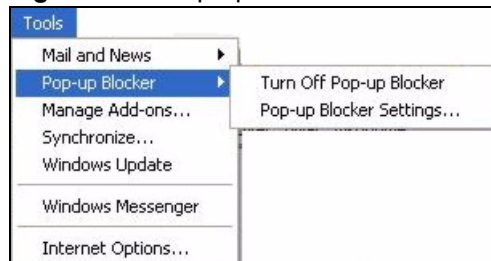

You can also check if pop-up blocking is disabled in the **Pop-up Blocker** section in the **Privacy** tab.

- 1 In Internet Explorer, select **Tools, Internet Options, Privacy**.
- 2 Clear the **Block pop-ups** check box in the **Pop-up Blocker** section of the screen. This disables any web pop-up blockers you may have enabled.

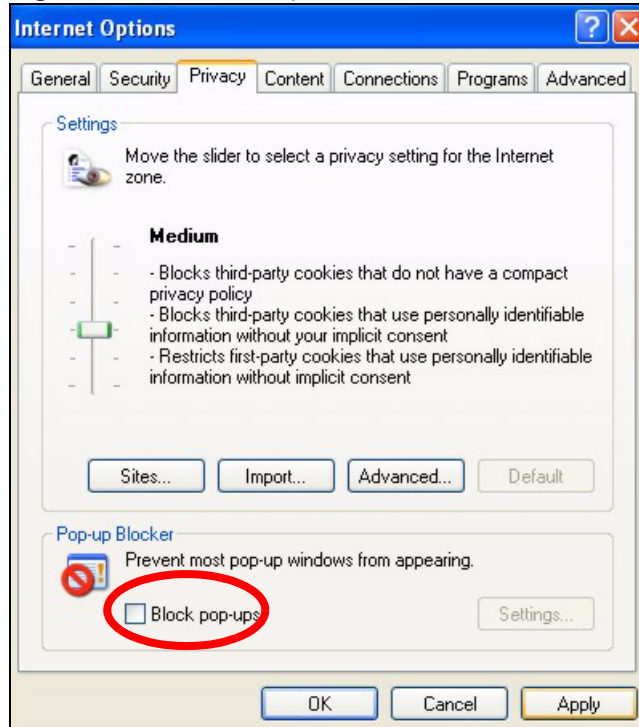
Figure 157 Internet Options

3 Click **Apply** to save this setting.

49.2.1.1.2 Enable pop-up Blockers with Exceptions

Alternatively, if you only want to allow pop-up windows from your device, see the following steps.

- 1** In Internet Explorer, select **Tools, Internet Options** and then the **Privacy** tab.
- 2** Select **Settings...** to open the **Pop-up Blocker Settings** screen.

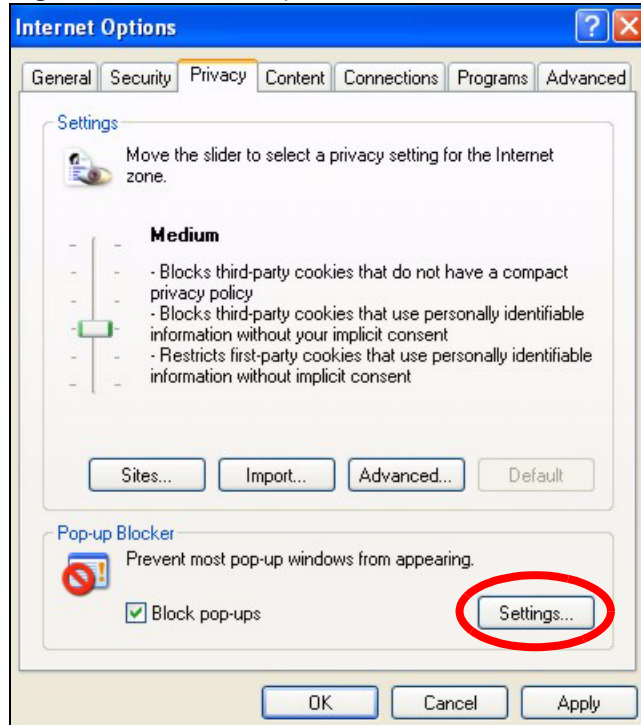
Figure 158 Internet Options

- 3** Type the IP address of your device (the web page that you do not want to have blocked) with the prefix “http://”. For example, http://192.168.1.1.
- 4** Click **Add** to move the IP address to the list of **Allowed sites**.

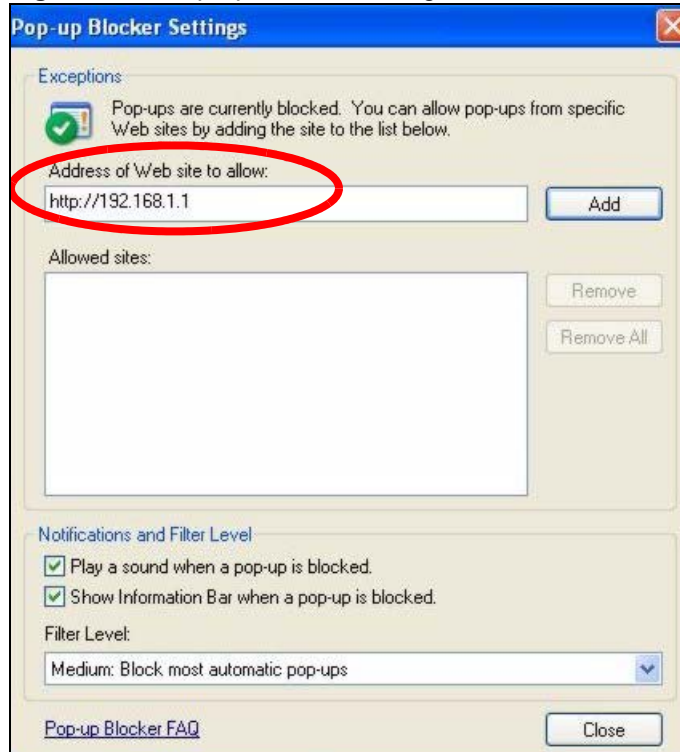
Figure 159 Pop-up Blocker Settings

5 Click **Close** to return to the **Privacy** screen.

6 Click **Apply** to save this setting.

49.2.1.2 JavaScripts

If pages of the web configurator do not display properly in Internet Explorer, check that JavaScripts are allowed.

1 In Internet Explorer, click **Tools, Internet Options** and then the **Security** tab.

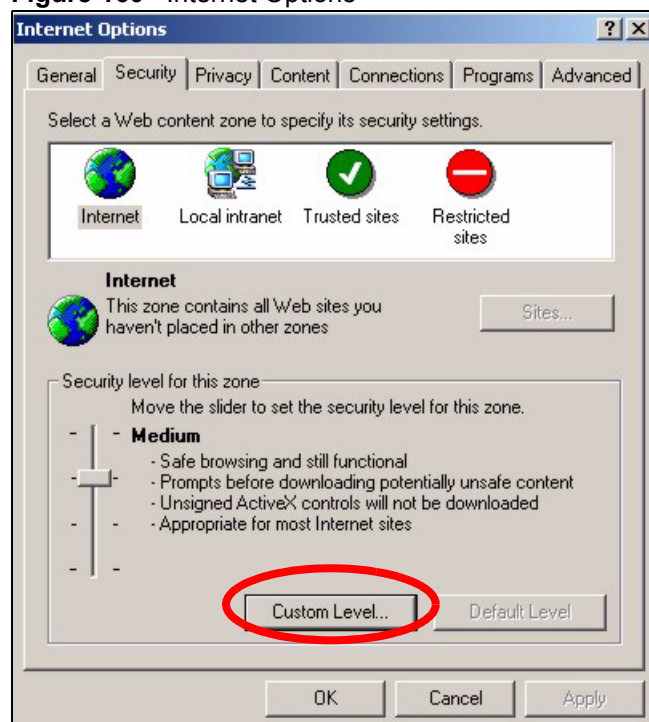
Figure 160 Internet Options

- 2** Click the **Custom Level...** button.
- 3** Scroll down to **Scripting**.
- 4** Under **Active scripting** make sure that **Enable** is selected (the default).
- 5** Under **Scripting of Java applets** make sure that **Enable** is selected (the default).
- 6** Click **OK** to close the window.

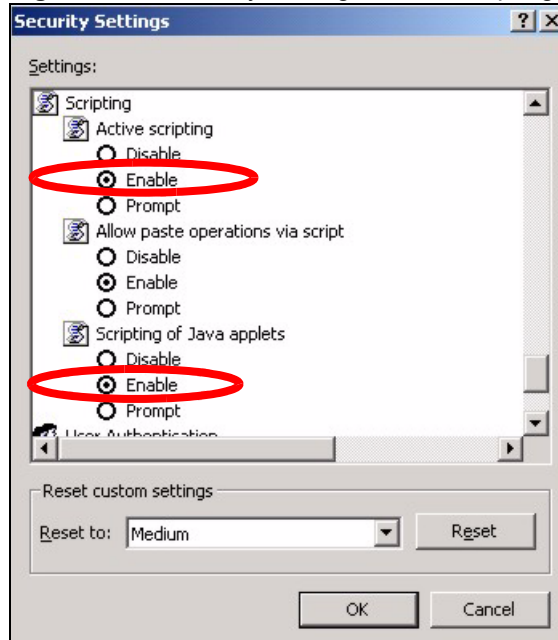
Figure 161 Security Settings - Java Scripting

49.2.1.3 Java Permissions

- 1 From Internet Explorer, click **Tools, Internet Options** and then the **Security** tab.
- 2 Click the **Custom Level...** button.
- 3 Scroll down to **Microsoft VM**.
- 4 Under **Java permissions** make sure that a safety level is selected.
- 5 Click **OK** to close the window.

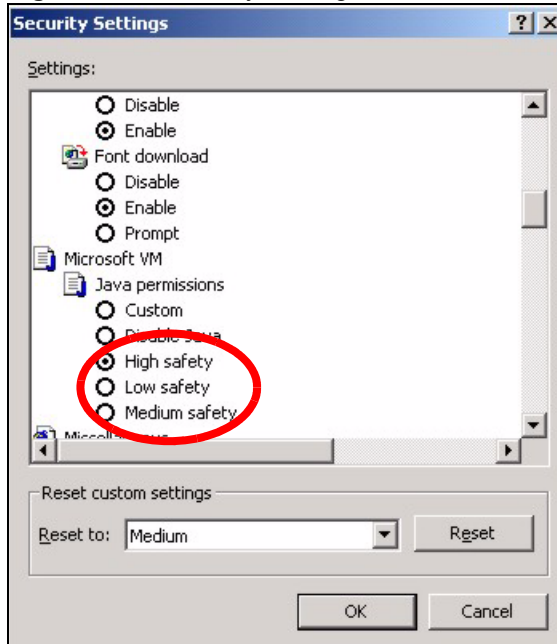
Figure 162 Security Settings - Java

49.2.1.3.1 JAVA (Sun)

- 1 From Internet Explorer, click **Tools, Internet Options** and then the **Advanced** tab.
- 2 make sure that **Use Java 2 for <applet>** under **Java (Sun)** is selected.
- 3 Click **OK** to close the window.

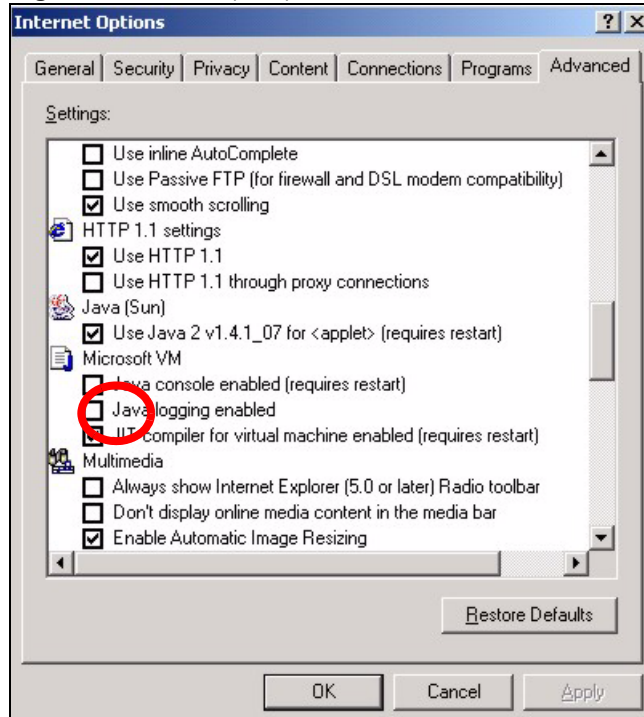
Figure 163 Java (Sun)

49.3 Problems with the Password

Table 113 Troubleshooting the Password

PROBLEM	CORRECTIVE ACTION
Cannot access the switch.	<p>The password field is case sensitive. Make sure that you enter the correct password using the proper casing.</p> <p>The administrator username is "admin". The default administrator password is "1234". The username and password are case-sensitive. Make sure that you enter the correct password and username using the proper casing. If you have changed the password and have now forgotten it, you will need to upload the default configuration file. This restores all of the factory defaults including the password.</p>

APPENDIX A

Product Specifications

This section describes the general software features of the switch.

Table 114 Firmware Features

FEATURE	DESCRIPTION
IP Routing Domain	An IP interface (also known as an IP routing domain) is not bound to a physical port. Configure an IP routing domain to allow the switch to route traffic between different networks.
VLAN	A VLAN (Virtual Local Area Network) allows a physical network to be partitioned into multiple logical networks. Devices on a logical network belong to one group. A device can belong to more than one group. With VLAN, a device cannot directly talk to or hear from devices that are not in the same group(s); the traffic must first go through a router.
VLAN Stacking	Use VLAN stacking to add an outer VLAN tag to the inner IEEE 802.1Q tagged frames that enter the network. By tagging the tagged frames ("double-tagged" frames), the service provider can manage up to 4,094 VLAN groups with each group containing up to 4,094 customer VLANs. This allows a service provider to provide different service, based on specific VLANs, for many different customers.
MAC Address Filter	Filter traffic based on the source and/or destination MAC address and VLAN group (ID).
DHCP (Dynamic Host Configuration Protocol)	Use this feature to have the switch assign IP addresses, an IP default gateway and DNS servers to computers on your network.
IGMP Snooping	The switch supports IGMP snooping enabling group multicast traffic to be only forwarded to ports that are members of that group; thus allowing you to significantly reduce multicast traffic passing through your switch.
Differentiated Services (DiffServ)	With DiffServ, the switch marks packets so that they receive specific per-hop treatment at DiffServ-compliant network devices along the route based on the application types and traffic flow.
Classifier and Policy	You can create a policy to define actions to be performed on a traffic flow grouped by a classifier according to specific criteria such as the IP address, port number or protocol type, etc.
Queuing	Queuing is used to help solve performance degradation when there is network congestion. Two scheduling services are supported: Strict Priority Queuing (SPQ) and Weighted Round Robin (WRR). This allows the switch to maintain separate queues for packets from each individual source or flow and prevent a source from monopolizing the bandwidth.
Port Mirroring	Port mirroring allows you to copy traffic going from one or all ports to another or all ports in order that you can examine the traffic from the mirror port (the port you copy the traffic to) without interference.
Static Route	Static routes tell the switch how to forward IP traffic when you configure the TCP/IP parameters manually.
Port Cloning	Port cloning allows you to copy attributes from one port to another port or ports.

Table 114 Firmware Features

FEATURE	DESCRIPTION
Multicast VLAN Registration (MVR)	Multicast VLAN Registration (MVR) is designed for applications (such as Media-on-Demand (MoD)) using multicast traffic across a network. MVR allows one single multicast VLAN to be shared among different subscriber VLANs on the network. This improves bandwidth utilization by reducing multicast traffic in the subscriber VLANs and simplifies multicast group management.
IP Multicast	With IP multicast, the switch delivers IP packets to a group of hosts on the network - not everybody. In addition, the switch can send packets to Ethernet devices that are not VLAN-aware by untagging (removing the VLAN tags) IP multicast packets.
RIP	RIP (Routing Information Protocol) allows a routing device to exchange routing information with other routers.
OSPF	OSPF (Open Shortest Path First) is a link-state protocol designed to distribute routing information within an autonomous system (AS). An autonomous system is a collection of networks using a common routing protocol to exchange routing information. OSPF is best suited for large networks.
DVMRP	DVMRP (Distance Vector Multicast Routing Protocol) is a protocol used for routing multicast data within an autonomous system (AS). DVMRP provides multicast forwarding capability to a layer 3 switch that runs both the IPv4 protocol (with IP Multicast support) and the IGMP protocol.
VRRP	Virtual Router Redundancy Protocol (VRRP), defined in RFC 2338, allows you to create redundant backup gateways to ensure that the default gateway of a host is always available.
RSTP (Rapid Spanning Tree Protocol) / MRSTP (Multiple RSTP)	RSTP detects and breaks network loops and provides backup links between switches, bridges or routers. It allows a switch to interact with other RSTP -compliant switches in your network to ensure that only one path exists between any two stations on the network. MRSTP allows you to configure multiple RSTP configurations and assign ports to each tree.
Link Aggregation	Link aggregation (trunking) is the grouping of physical ports into one logical higher-capacity link. You may want to trunk ports if for example, it is cheaper to use multiple lower-speed links than to under-utilize a high-speed, but more costly, single-port link.
Port Authentication and Security	For security, the switch allows authentication using IEEE 802.1x with an external RADIUS server and port security that allows only packets with dynamically learned MAC addresses and/or configured static MAC addresses to pass through a port on the switch. For redundancy, multiple RADIUS servers can be configured.
Device Management	Use the web configurator to easily configure the rich range of features on the switch.
Firmware Upgrade	Download new firmware (when available) from the ZyXEL web site and use the web configurator, CLI or an FTP/TFTP tool to put it on the switch. Note: Only upload firmware for your specific model!
Configuration Backup & Restoration	Make a copy of the switch's configuration and put it back on the switch later if you decide you want to revert back to an earlier configuration.
Cluster Management	Cluster management (also known as iStacking) allows you to manage switches through one switch, called the cluster manager. The switches must be directly connected and be in the same VLAN group so as to be able to communicate with one another.

The following table lists the product specifications.

Table 115 General Product Specifications

Interface		GS-4012F: 8 mini-GBIC (SFP) slots GS-4024: 20 10/100/1000 Base-Tx ports All Models: 4 GbE Dual Personality interfaces (Each interface has one 1000Base-T copper port and one Small Form-Factor Pluggable (SFP) fiber port, with one port active at a time.) One local management Ethernet port Auto-negotiation Auto-MDIX Compliant with IEEE 802.3ad/u/x Back pressure flow control for half duplex Flow control for full duplex (IEEE 802.3x) RJ-45 Ethernet cable connector Rate limiting at 64Kbps steps
Layer 2 Features	Bridging	16K MAC addresses Static MAC address filtering by source/destination Broadcast storm control Static MAC address forwarding
	Switching	Switching fabric: 48 Gbps, non-blocking Max. Frame size: 1522 bytes Forwarding frame: IEEE 802.3, IEEE 802.1q, Ethernet II, PPPoE Prevent the forwarding of corrupted packets
	STP	IEEE 802.1w Rapid Spanning Tree Protocol (RSTP) Multiple Rapid Spanning Tree capability (4 configurable trees)
	QoS	IEEE 802.1p Eight priority queues per port Port-based egress traffic shaping Rule-based traffic mirroring Supports IGMP snooping
	VLAN	Port-based VLAN setting Tag-based (IEEE 802.1Q) VLAN Number of VLAN: 4K, 256 static maximum Supports GVRP Double tagging for VLAN stacking
	Port Aggregation	Supports IEEE 802.3ad; static and dynamic (LACP) port trunking Six groups (up to 8 ports each)
	Port mirroring	All ports support port mirroring Support port mirroring per IP/TCP/UDP
	Bandwidth control	Supports rate limiting at 64K increment

Table 115 General Product Specifications (continued)

Layer 3 Features	IP Capability	IPV4 support 64 IP routing domains 4K IP address table Wire speed IP forwarding
	Routing protocols	Unicast: RIP-V1/V2, OSPF V2 Multicast: DVMRP, IGMP V1/V2 Static Routing VRRP
	IP services	DHCP server/relay
Security		IEEE 802.1x port-based authentication Static MAC address filtering Limiting number of dynamic addresses per port

Table 116 Management Specifications

System Control	Alarm/Status surveillance LED indication for alarm and system status Performance monitoring Line speed Four RMON groups (history, statistics, alarms, and events) Throughput monitoring Port mirroring and aggregation Spanning Tree Protocol IGMP snooping Firmware upgrade and download through FTP/TFTP DHCP server/relay Login authorization and security levels (Privileges assigned via CLI or via RADIUS server) Self diagnostics FLASH memory
Network Management	CLI through console port and Telnet Web-based management Clustering: up to 24 switches can be managed by one IP address SNMP RMON groups (history, statistics, alarms and events)
MIB	RFC1213 MIB II RFC2011 IP MIB RFC2012 TCP MIB RFC2014 UDP MIB RFC1493 Bridge MIB RFC1643 Ethernet MIB RFC1757 Four groups of RMON RFC2674 Bridge MIB extension

Table 117 Physical and Environmental Specifications

LEDs	Per switch: BPS, PWR, SYS, ALM Per Gigabit Ethernet/mini-GBIC port: 100, 1000/LNK, ACT Per mini-GBIC port: LNK, ACT Per Management port: 10, 100
Dimension	Standard 19" rack mountable GS-4012F: 438 mm (W) x 225 mm (D) x 44.45 mm (H) GS-4024: 438 mm (W) x 300 mm (D) x 44.45 mm (H)
Weight	GS-4012F: 3.1 Kg GS-4024: 4.2 Kg
Temperature	Operating: 0° C ~ 45° C (32° F ~ 113° F) Storage: -25° C ~ 70° C (13° F ~ 158° F)
Humidity	10 ~ 90% (non-condensing)
Safety	UL 60950-1 CSA 60950-1 EN 60950-1 IEC 60950-1
EMC	FCC Part 15 (Class A) CE EMC (Class A)

Table 118 Power Specifications

MODEL	GS-4012F	GS-4024
AC	100-240 VAC 50/60 Hz, .5 A Max.	100-240 VAC 50/60 Hzx 1.5 A Max.
DC	-48 VDC ~ -60 VDC, 1.6 A Max.	-48 VDC ~ -60 VDC, 2.2 A Max.

APPENDIX B

IP Addresses and Subnetting

This appendix introduces IP addresses, IP address classes and subnet masks. You use subnet masks to subdivide a network into smaller logical networks.

Introduction to IP Addresses

An IP address has two parts: the network number and the host ID. Routers use the network number to send packets to the correct network, while the host ID identifies a single device on the network.

An IP address is made up of four octets, written in dotted decimal notation, for example, 192.168.1.1. (An octet is an 8-digit binary number. Therefore, each octet has a possible range of 00000000 to 11111111 in binary, or 0 to 255 in decimal.)

There are several classes of IP addresses. The first network number (192 in the above example) defines the class of IP address. These are defined as follows:

- Class A: 0 to 127
- Class B: 128 to 191
- Class C: 192 to 223
- Class D: 224 to 239
- Class E: 240 to 255

IP Address Classes and Hosts

The class of an IP address determines the number of hosts you can have on your network.

- In a class A address the first octet is the network number, and the remaining three octets are the host ID.
- In a class B address the first two octets make up the network number, and the two remaining octets make up the host ID.
- In a class C address the first three octets make up the network number, and the last octet is the host ID.

The following table shows the network number and host ID arrangement for classes A, B and C.

Table 119 Classes of IP Addresses

IP ADDRESS	OCTET 1	OCTET 2	OCTET 3	OCTET 4
Class A	Network number	Host ID	Host ID	Host ID
Class B	Network number	Network number	Host ID	Host ID
Class C	Network number	Network number	Network number	Host ID

An IP address with host IDs of all zeros is the IP address of the network (192.168.1.0 for example). An IP address with host IDs of all ones is the broadcast address for that network (192.168.1.255 for example). Therefore, to determine the total number of hosts allowed in a network, deduct two as shown next:

- A class C address (1 host octet: 8 host bits) can have $2^8 - 2$, or 254 hosts.
- A class B address (2 host octets: 16 host bits) can have $2^{16} - 2$, or 65534 hosts.

A class A address (3 host octets: 24 host bits) can have $2^{24} - 2$ hosts, or approximately 16 million hosts.

IP Address Classes and Network ID

The value of the first octet of an IP address determines the class of an address.

- Class A addresses have a **0** in the leftmost bit.
- Class B addresses have a **1** in the leftmost bit and a **0** in the next leftmost bit.
- Class C addresses start with **1 1 0** in the first three leftmost bits.
- Class D addresses begin with **1 1 1 0**. Class D addresses are used for multicasting, which is used to send information to groups of computers.
- There is also a class E. It is reserved for future use.

The following table shows the allowed ranges for the first octet of each class. This range determines the number of subnets you can have in a network.

Table 120 Allowed IP Address Range By Class

CLASS	ALLOWED RANGE OF FIRST OCTET (BINARY)	ALLOWED RANGE OF FIRST OCTET (DECIMAL)
Class A	00000000 to 01111111	0 to 127
Class B	10000000 to 10111111	128 to 191
Class C	11000000 to 11011111	192 to 223
Class D	11100000 to 11101111	224 to 239
Class E (reserved)	11110000 to 11111111	240 to 255

Subnet Masks

A subnet mask is used to determine which bits are part of the network number, and which bits are part of the host ID (using a logical AND operation).

A subnet mask has 32 bits. If a bit in the subnet mask is a “1” then the corresponding bit in the IP address is part of the network number. If a bit in the subnet mask is “0” then the corresponding bit in the IP address is part of the host ID.

Subnet masks are expressed in dotted decimal notation just like IP addresses. The “natural” masks for class A, B and C IP addresses are as follows.

Table 121 “Natural” Masks

CLASS	NATURAL MASK
A	255.0.0.0
B	255.255.0.0
C	255.255.255.0

Subnetting

With subnetting, the class arrangement of an IP address is ignored. For example, a class C address no longer has to have 24 bits of network number and 8 bits of host ID. With subnetting, some of the host ID bits are converted into network number bits.

By convention, subnet masks always consist of a continuous sequence of ones beginning from the leftmost bit of the mask, followed by a continuous sequence of zeros, for a total number of 32 bits.

Since the mask is always a continuous number of ones beginning from the left, followed by a continuous number of zeros for the remainder of the 32 bit mask, you can simply specify the number of ones instead of writing the value of each octet. This is usually specified by writing a “/” followed by the number of bits in the mask after the address.

For example, 192.1.1.0 /25 is equivalent to saying 192.1.1.0 with mask 255.255.255.128.

The following table shows all possible subnet masks for a class “C” address using both notations.

Table 122 Alternative Subnet Mask Notation

SUBNET MASK	SUBNET MASK “1” BITS	LAST OCTET BIT VALUE	DECIMAL
255.255.255.0	/24	0000 0000	0
255.255.255.128	/25	1000 0000	128
255.255.255.192	/26	1100 0000	192
255.255.255.224	/27	1110 0000	224

Table 122 Alternative Subnet Mask Notation (continued)

SUBNET MASK	SUBNET MASK "1" BITS	LAST OCTET BIT VALUE	DECIMAL
255.255.255.240	/28	1111 0000	240
255.255.255.248	/29	1111 1000	248
255.255.255.252	/30	1111 1100	252

The first mask shown is the class "C" natural mask. Normally if no mask is specified it is understood that the natural mask is being used.

Example: Two Subnets

As an example, you have a class "C" address 192.168.1.0 with subnet mask of 255.255.255.0.

Table 123 Two Subnets Example

IP/SUBNET MASK	NETWORK NUMBER	HOST ID
IP Address	192.168.1.	0
IP Address (Binary)	11000000.10101000.00000001.	00000000
Subnet Mask	255.255.255.	0
Subnet Mask (Binary)	11111111.11111111.11111111.	00000000

The first three octets of the address make up the network number (class "C").

To make two networks, divide the network 192.168.1.0 into two separate subnets by converting one of the host ID bits of the IP address to a network number bit. The "borrowed" host ID bit can be either "0" or "1" thus giving two subnets; 192.168.1.0 with mask 255.255.255.128 and 192.168.1.128 with mask 255.255.255.128.

Note: In the following charts, shaded/bolded last octet bit values indicate host ID bits "borrowed" to make network ID bits. The number of "borrowed" host ID bits determines the number of subnets you can have. The remaining number of host ID bits (after "borrowing") determines the number of hosts you can have on each subnet.

Table 124 Subnet 1

IP/SUBNET MASK	NETWORK NUMBER	LAST OCTET BIT VALUE
IP Address	192.168.1.	0
IP Address (Binary)	11000000.10101000.00000001.	00000000
Subnet Mask	255.255.255.	128
Subnet Mask (Binary)	11111111.11111111.11111111.	10000000

Table 124 Subnet 1 (continued)

IP/SUBNET MASK	NETWORK NUMBER	LAST OCTET BIT VALUE
Subnet Address: 192.168.1.0	Lowest Host ID: 192.168.1.1	
Broadcast Address: 192.168.1.127	Highest Host ID: 192.168.1.126	

Table 125 Subnet 2

IP/SUBNET MASK	NETWORK NUMBER	LAST OCTET BIT VALUE
IP Address	192.168.1.	128
IP Address (Binary)	11000000.10101000.00000001.	10000000
Subnet Mask	255.255.255.	128
Subnet Mask (Binary)	11111111.11111111.11111111.	10000000
Subnet Address: 192.168.1.128	Lowest Host ID: 192.168.1.129	
Broadcast Address: 192.168.1.255	Highest Host ID: 192.168.1.254	

Host IDs of all zeros represent the subnet itself and host IDs of all ones are the broadcast address for that subnet, so the actual number of hosts available on each subnet in the example above is $2^7 - 2$ or 126 hosts for each subnet.

192.168.1.0 with mask 255.255.255.128 is the subnet itself, and 192.168.1.127 with mask 255.255.255.128 is the directed broadcast address for the first subnet. Therefore, the lowest IP address that can be assigned to an actual host for the first subnet is 192.168.1.1 and the highest is 192.168.1.126. Similarly the host ID range for the second subnet is 192.168.1.129 to 192.168.1.254.

Example: Four Subnets

The above example illustrated using a 25-bit subnet mask to divide a class “C” address space into two subnets. Similarly to divide a class “C” address into four subnets, you need to “borrow” two host ID bits to give four possible combinations (00, 01, 10 and 11). The subnet mask is 26 bits (11111111.11111111.11111111.11000000) or 255.255.255.192. Each subnet contains 6 host ID bits, giving $2^6 - 2$ or 62 hosts for each subnet (all zeroes is the subnet itself, all ones is the broadcast address on the subnet).

Table 126 Subnet 1

IP/SUBNET MASK	NETWORK NUMBER	LAST OCTET BIT VALUE
IP Address	192.168.1.	0
IP Address (Binary)	11000000.10101000.00000001.	00000000
Subnet Mask (Binary)	11111111.11111111.11111111.	11000000

Table 126 Subnet 1 (continued)

IP/SUBNET MASK	NETWORK NUMBER	LAST OCTET BIT VALUE
Subnet Address: 192.168.1.0	Lowest Host ID: 192.168.1.1	
Broadcast Address: 192.168.1.63	Highest Host ID: 192.168.1.62	

Table 127 Subnet 2

IP/SUBNET MASK	NETWORK NUMBER	LAST OCTET BIT VALUE
IP Address	192.168.1.	64
IP Address (Binary)	11000000.10101000.00000001.	01000000
Subnet Mask (Binary)	11111111.11111111.11111111.	11000000
Subnet Address: 192.168.1.64	Lowest Host ID: 192.168.1.65	
Broadcast Address: 192.168.1.127	Highest Host ID: 192.168.1.126	

Table 128 Subnet 3

IP/SUBNET MASK	NETWORK NUMBER	LAST OCTET BIT VALUE
IP Address	192.168.1.	128
IP Address (Binary)	11000000.10101000.00000001.	10000000
Subnet Mask (Binary)	11111111.11111111.11111111.	11000000
Subnet Address: 192.168.1.128	Lowest Host ID: 192.168.1.129	
Broadcast Address: 192.168.1.191	Highest Host ID: 192.168.1.190	

Table 129 Subnet 4

IP/SUBNET MASK	NETWORK NUMBER	LAST OCTET BIT VALUE
IP Address	192.168.1.	192
IP Address (Binary)	11000000.10101000.00000001.	11000000
Subnet Mask (Binary)	11111111.11111111.11111111.	11000000
Subnet Address: 192.168.1.192	Lowest Host ID: 192.168.1.193	
Broadcast Address: 192.168.1.255	Highest Host ID: 192.168.1.254	

Example Eight Subnets

Similarly use a 27-bit mask to create eight subnets (000, 001, 010, 011, 100, 101, 110 and 111).

The following table shows class C IP address last octet values for each subnet.

Table 130 Eight Subnets

SUBNET	SUBNET ADDRESS	FIRST ADDRESS	LAST ADDRESS	BROADCAST ADDRESS
1	0	1	30	31
2	32	33	62	63
3	64	65	94	95
4	96	97	126	127
5	128	129	158	159
6	160	161	190	191
7	192	193	222	223
8	224	225	254	255

The following table is a summary for class “C” subnet planning.

Table 131 Class C Subnet Planning

NO. “BORROWED” HOST BITS	SUBNET MASK	NO. SUBNETS	NO. HOSTS PER SUBNET
1	255.255.255.128 (/25)	2	126
2	255.255.255.192 (/26)	4	62
3	255.255.255.224 (/27)	8	30
4	255.255.255.240 (/28)	16	14
5	255.255.255.248 (/29)	32	6
6	255.255.255.252 (/30)	64	2
7	255.255.255.254 (/31)	128	1

Subnetting With Class A and Class B Networks.

For class “A” and class “B” addresses the subnet mask also determines which bits are part of the network number and which are part of the host ID.

A class “B” address has two host ID octets available for subnetting and a class “A” address has three host ID octets (see [Table 119 on page 348](#)) available for subnetting.

The following table is a summary for class "B" subnet planning.

Table 132 Class B Subnet Planning

NO. "BORROWED" HOST BITS	SUBNET MASK	NO. SUBNETS	NO. HOSTS PER SUBNET
1	255.255.128.0 (/17)	2	32766
2	255.255.192.0 (/18)	4	16382
3	255.255.224.0 (/19)	8	8190
4	255.255.240.0 (/20)	16	4094
5	255.255.248.0 (/21)	32	2046
6	255.255.252.0 (/22)	64	1022
7	255.255.254.0 (/23)	128	510
8	255.255.255.0 (/24)	256	254
9	255.255.255.128 (/25)	512	126
10	255.255.255.192 (/26)	1024	62
11	255.255.255.224 (/27)	2048	30
12	255.255.255.240 (/28)	4096	14
13	255.255.255.248 (/29)	8192	6
14	255.255.255.252 (/30)	16384	2
15	255.255.255.254 (/31)	32768	1

Index

Numerics

802.1P priority [79](#)

A

access control
 limitations [215](#)
 login account [218](#)
 remote management [226](#)
 service port [225](#)
 SNMP [216](#)

accounts
 and modes [256](#)

Address Resolution Protocol (ARP) [247](#), [251](#)

administrator password [219](#)

aggregator ID [115](#)

aging time [74](#)

alternative subnet mask notation [349](#)

applications
 backbone [31](#)
 bridging [32](#)
 IEEE 802.1Q VLAN [33](#)
 switched workgroup [33](#)

Area Border Router (ABR) [169](#)

area ID
 and OSPF [175](#)

ARP
 how it works [247](#)
 viewing [247](#)

ARP (Address Resolution Protocol) [247](#)

AS Boundary Router [169](#)

authentication [176](#)
 and OSPF [175](#)

automatic VLAN registration [82](#)

Autonomous System
 and OSPF [169](#)

Autonomous System (AS) [169](#), [183](#)

B

back up, configuration file [212](#)

Backbone Router (BR) [169](#)

backbone, routing [169](#)

Backup Designated Router(BDR), and OSPF [170](#)

basic settings [69](#)

BDR (Backup Designated Router) [170](#)

BPDUs (Bridge Protocol Data Units) [98](#)

Bridge Protocol Data Units (BPDUs) [98](#)

C

certifications [2](#)
 viewing [2](#)

CFI (Canonical Format Indicator) [81](#)

changing the password [52](#)

Class of Service (CoS) [189](#)

classifier [129](#), [131](#)
 and QoS [129](#)
 editing [132](#)
 example [133](#)
 overview [129](#)
 setup [129](#), [131](#), [132](#)
 viewing [132](#)

CLI
 syntax conventions [254](#)

cloning a port See port cloning

cluster management [235](#)
 and switch passwords [241](#)
 cluster manager [235](#), [240](#)
 cluster member [235](#), [241](#)
 cluster member firmware upgrade [238](#)
 network example [235](#)
 setup [239](#)
 specification [235](#)
 status [236](#)
 switch models [235](#)
 VID [240](#)
 web configurator [237](#)

cluster manager [235](#)

cluster member [235](#)

Command Line Interface
 introduction [253](#)

Command Line Interface (CLI) [253](#)

Command Line Interface, See also commands
 accessing [253](#)

commands [253](#)
 accessing [253](#)
 and configuration file [259](#)

- and passwords [255](#)
- configure tagged VLAN example [319](#)
- exit [260](#)
- forwarding process example [323](#)
- getting help [257](#)
- interface [311](#)
- logging in [254](#)
- modes [256](#)
- modes summary [256](#)
- static VLAN table example [323](#)
- summary [260](#)
- syntax conventions [254](#)
- user mode details [260](#)
- using history [259](#)
- VLAN [319](#)

config mode [256](#)

- examples [299](#)

configuration [166](#)

- change running config [211](#)
- saving [259](#)

configuration file [54, 259](#)

- and commands [259](#)
- backup [212](#)
- restore [54, 212](#)
- saving [210](#)

configuration, saving [53](#)

console port

- commands [253](#)
- settings [40, 253](#)

copying port settings, See port cloning

copyright [1](#)

CPU management port [89](#)

current date [73](#)

current time [73](#)

D

Database Description (DD) [170](#)

default gateway [195](#)

Designated Router(DR), and OSPF [170](#)

DHCP [193](#)

- client IP pool [195](#)
- modes [193](#)
- relay agent [193](#)
- server [193](#)
- setup [194](#)

DHCP (Dynamic Host Configuration Protocol) [193](#)

diagnostics [229](#)

- Ethernet port test [229](#)
- ping [229](#)
- system log [229](#)

Differentiated Service (DiffServ) [189](#)

DiffServ [189](#)

- activate [190](#)
- DS field [189](#)
- DSCP [189](#)
- DSCP-to-IEEE802.1p mapping [191](#)
- network example [189](#)
- PHB [189](#)

disclaimer [1](#)

double-tagged frames [147](#)

DR (Designated Router) [170](#)

DS (Differentiated Services) [189](#)

DSCP

- DSCP-to-IEEE802.1p mapping [191](#)
- service level [189](#)
- what it does [189](#)

DSCP (DiffServ Code Point) [189](#)

DVMRP

- Autonomous System [183](#)
- default timer setting [186](#)
- error message [185](#)
- graft [184](#)
- how it works [183](#)
- implementation [183](#)
- probe [184](#)
- prune [184](#)
- report [184](#)
- setup [184](#)
- terminology [184](#)
- threshold [185](#)

DVMRP (Distance Vector Multicast Routing Protocol) [183](#)

dynamic link aggregation [113](#)

E

egress port [92](#)

enable mode [256](#)

- examples [291](#)

Ethernet broadcast address [247](#)

Ethernet port test [229](#)

Ethernet ports

- default settings [41](#)

extended authentication protocol [119](#)

external authentication server [119](#)

F

fan speed [71](#)

FCC interference statement [2](#)

feature summary [50](#)

file transfer using FTP

- command example [213](#)
- filename convention, configuration
 - configuration
 - file names [213](#)
- filtering [95](#)
 - rules [95](#)
- filtering database, MAC table [243](#)
- firmware [70](#)
 - upgrade [211](#), [238](#)
- flow control [79](#)
 - back pressure [79](#)
 - IEEE802.3x [79](#)
- frames
 - tagged [88](#)
 - untagged [88](#)
- front panel [39](#)
- FTP [213](#)
 - file transfer procedure [214](#)
 - restrictions over WAN [214](#)

G

- GARP [82](#)
- GARP (Generic Attribute Registration Protocol) [82](#)
- GARP terminology [82](#)
- GARP timer [74](#), [82](#)
- general setup [71](#)
- getting help [55](#)
- gigabit Ethernet ports [40](#)
- GMT (Greenwich Mean Time) [73](#)
- GVRP [82](#), [88](#)
 - and port assignment [88](#)
- GVRP (GARP VLAN Registration Protocol) [82](#), [314](#)

H

- hardware installation [35](#)
- hardware monitor [70](#)
- hardware overview [39](#)
- help
 - in command interpreter [257](#)
- history
 - in command interpreter [259](#)
- HTTPS [222](#)
 - certificates [222](#)
 - implementation [222](#)
 - public keys, private keys [222](#)
- HTTPS example [223](#)

I

- IEEE 802.1p, priority [75](#)
- IEEE 802.1x [119](#)
 - activate [122](#)
 - reauthentication [122](#)
- IEEE 802.1x, port authentication [119](#)
- IGMP [181](#), [183](#)
 - setup [181](#)
 - version [153](#), [181](#)
- IGMP (Internet Group Multicast Protocol) [153](#)
- IGMP filtering [153](#)
 - profile [157](#)
 - profiles [155](#)
- IGMP snooping [153](#)
 - MVR [158](#)
- ingress port [92](#)
- installation
 - freestanding [35](#)
 - precautions [36](#)
 - rack-mounting [36](#)
- interface [172](#)
 - and OSPF [177](#)
- interface commands [311](#)
- interface, and OSPF [170](#)
- Internal Router (IR) [169](#)
- introduction [31](#)
- IP
 - interface [76](#), [201](#)
 - routing domain [76](#)
 - setup [75](#)
- IP table [245](#)
 - how it works [245](#)

L

- LACP [113](#)
 - system priority [116](#)
 - timeout [117](#)
- LEDs [44](#)
- limit MAC address learning [126](#)
- Link Aggregate Control Protocol (LACP) [113](#)
- link aggregation [113](#)
 - dynamic [113](#)
 - ID information [114](#)
 - setup [115](#)
 - status [115](#)
- link state database [170](#), [172](#)
- lockout [53](#)
- log [229](#)
- login [47](#)

- password [52](#)
- login account
 - Administrator [218](#)
 - non-administrator [219](#)
- login accounts [218](#)
 - configuring via web configurator [218](#)
 - multiple [218](#)
 - number of [218](#)
- login password [219](#)
- LSA (Link State Advertisement) [170](#)

M

- MAC (Media Access Control) [70](#)
- MAC address [70](#), [247](#)
 - maximum number per port [126](#)
- MAC address learning [74](#), [93](#), [126](#)
 - specify limit [126](#)
- MAC table [243](#)
 - how it works [243](#)
 - viewing [244](#)
- maintenance
 - configuration backup [212](#)
 - firmware [211](#)
 - restoring configuration [212](#)
- maintenance [209](#)
 - current configuration [209](#)
 - main screen [209](#)
- Management Information Base (MIB) [216](#)
- management port [92](#)
- managementmanagement interface, See also CLI
- metric [174](#)
- MIB
 - and SNMP [216](#)
 - supported MIBs [217](#)
- MIB (Management Information Base) [216](#)
- mini GBIC ports [41](#)
 - connection speed [41](#)
 - connector type [41](#)
 - transceiver installation [41](#)
 - transceiver removal [42](#)
- mirroring ports [111](#)
- modes
 - and accounts [256](#)
 - in command interpreter [256](#)
- monitor port [111](#), [112](#)
- mounting brackets [36](#)
- MSA (MultiSource Agreement) [41](#)
- MTU (Multi-Tenant Unit) [73](#)
- multicast [153](#), [187](#)
 - 802.1 priority [155](#)
 - and IGMP [153](#)

- and VLAN [187](#)
- configuration [187](#)
- IP addresses [153](#)
- overview [153](#), [187](#)
- setup [154](#), [155](#)
- vs. unicast [187](#)
- vs. broadcast [187](#)
- multicast delivery tree [184](#)
- multicast group [157](#)
- multicast router ('mrouter') [184](#)
- multicast VLAN [161](#)
- Multiple Spanning Tree Protocol [99](#)
- Multiple STP [99](#)
- MVR [158](#)
 - configuration [159](#)
 - group configuration [161](#)
 - network example [158](#)
- MVR (Multicast VLAN Registration) [158](#)

N

- network management system (NMS) [216](#)
- no commands examples [303](#)
- NTP (RFC-1305) [73](#)

O

- OSPF [169](#)
 - advantages [169](#)
 - area [169](#), [175](#)
 - Area 0 [169](#)
 - area ID [175](#)
 - authentication [175](#), [176](#)
 - autonomous system [169](#)
 - backbone [169](#)
 - configuration steps [171](#)
 - general settings [173](#)
 - how it works [170](#)
 - interface [170](#), [172](#), [177](#)
 - link state database [170](#), [172](#)
 - network example [170](#)
 - priority [171](#)
 - redistribute route [174](#)
 - route cost [176](#)
 - router elections [170](#)
 - router ID [174](#)
 - router types [169](#)
 - status [171](#)
 - stub area [169](#), [176](#)
 - virtual link [170](#)
 - virtual links [178](#)

vs RIP [169](#)
 OSPF (Open Shortest Path First) [169](#)

P

password [52](#)
 administrator [219](#)
 PHB (Per-Hop Behavior) [189](#)
 ping, test connection [229](#)
 policy [137](#), [139](#)
 and classifier [137](#)
 and DiffServ [135](#)
 configuration [137](#)
 example [140](#)
 overview [135](#)
 rules [135](#), [136](#)
 viewing [139](#)
 policy configuration [139](#)
 port authentication [119](#)
 and RADIUS [119](#), [121](#)
 and VSA [120](#)
 IEEE802.1x [122](#)
 port based VLAN type [74](#)
 port cloning [251](#)
 advanced settings [251](#)
 basic settings [251](#)
 port details [64](#)
 port isolation [88](#), [92](#)
 port mirroring [111](#), [112](#), [285](#)
 and commands [313](#)
 direction [112](#)
 egress [112](#)
 ingress [112](#)
 port redundancy [113](#)
 port security [125](#)
 limit MAC address learning [126](#)
 MAC address learning [125](#)
 overview [125](#)
 setup [125](#)
 port setup [78](#)
 port status [63](#)
 port VID
 default for all ports [286](#)
 port VLAN trunking [83](#)
 port-based VLAN [88](#)
 all connected [92](#)
 port isolation [92](#)
 settings wizard [92](#)
 ports
 “standby” [113](#)
 diagnostics [229](#)
 mirroring [111](#)

 speed/duplex [79](#)
 power
 backup power supply connector [44](#)
 voltage [71](#)
 power status [71](#)
 priority level [75](#)
 priority, and OSPF [171](#)
 priority, queue assignment [75](#)
 product registration [6](#)
 product specification [343](#)
 PVID [81](#), [88](#)
 PVID (Priority Frame) [81](#)

Q

QoS
 and classifier [129](#)
 Queue priority [144](#)
 Queue weight [144](#)
 queue weight [143](#)
 queuing [143](#)
 SPQ [143](#)
 WRR [143](#)
 Queuing algorithm [144](#)
 Queuing method [144](#)
 Calculate [145](#)
 queuing method [143](#)

R

RADIUS [119](#)
 advantages [119](#)
 and port authentication [119](#)
 Network example [119](#)
 server [119](#)
 settings [121](#)
 RADIUS (Remote Authentication Dial In User Service) [119](#)
 Rapid Spanning Tree Protocol (RSTP). See STP [97](#)
 rear panel [43](#)
 reboot
 load configuration [211](#)
 reboot system [211](#)
 redistribute route [174](#)
 registration
 product [6](#)
 related documentation [29](#)
 remote management [226](#)

- service [227](#)
- trusted computers [227](#)
- resetting [54, 210](#)
 - to factory default settings [210](#)
- restoring configuration [54, 212](#)
- Reverse Path Forwarding (RPF) [184](#)
- Reverse Path Multicasting (RPM) [183](#)
- RFC 3164 [231](#)
- RFC 3580 [120](#)
- RIP
 - configuration [167](#)
 - direction [167](#)
 - overview [167](#)
 - version [167](#)
 - vs OSPF [169](#)
- RIP (Routing Information Protocol) [167](#)
- Round Robin Scheduling [143](#)
- router ID [174](#)
- routing domain [76, 201](#)
- routing protocols [174](#)
- routing table [249](#)
- RSTP [97](#)
 - See also STP
- rubber feet [35](#)

S

- safety warnings [4](#)
- save configuration [53, 210](#)
- screen summary [50](#)
- Secure Shell See SSH
- service access control [225](#)
 - service port [226](#)
- SFP (Small Form-factor Pluggable) [41](#)
- show commands
 - examples [291](#)
- Simple Network Management Protocol, See SNMP
- SNMP [216](#)
 - agent [216](#)
 - and MIB [216](#)
 - communities [218](#)
 - management model [216](#)
 - manager [216](#)
 - MIB [217](#)
 - network components [216](#)
 - object variables [216](#)
 - protocol operations [216](#)
 - setup [218](#)
 - traps [217](#)
 - versions supported [216](#)
- SNMP traps [217](#)

- Spanning Tree Protocol (STP) [97](#)
- SPQ (Strict Priority Queuing) [143](#)
- SSH
 - encryption methods [221](#)
 - how it works [220](#)
 - implementation [221](#)
- SSH (Secure Shell) [220](#)
- SSL (Secure Socket Layer) [222](#)
- standby ports [113](#)
- static MAC address [93](#)
- static MAC forwarding [93](#)
- static routes [165, 166](#)
- Static VLAN [85](#)
- static VLAN
 - control [86](#)
 - tagging [86](#)
- status [48, 63](#)
 - LED [44](#)
 - link aggregation [115](#)
 - OSPF [171](#)
 - port [63](#)
 - port details [64](#)
 - power [71](#)
 - STP [102, 105](#)
 - VLAN [84](#)
 - VRRP [200](#)
- STP [97](#)
 - bridge ID [103, 106](#)
 - bridge priority [101, 104](#)
 - configuration [100, 103](#)
 - designated bridge [98](#)
 - forwarding delay [102, 105](#)
 - Hello BPDU [98](#)
 - Hello Time [101, 103, 104, 106](#)
 - how it works [98](#)
 - Max Age [101, 103, 105, 106](#)
 - path cost [97, 102, 105](#)
 - port priority [102, 105](#)
 - port state [98](#)
 - root port [98](#)
 - status [102, 105](#)
 - terminology [97](#)
- stub area [169, 176](#)
- stub area, See also OSPF [176](#)
- subnet [347](#)
- subnet mask [349](#)
- subnetting [349](#)
- switch lockout [53](#)
- switch reset [54](#)
- switch setup [74](#)
- syntax conventions [29](#)
- syslog [231](#)
 - protocol [231](#)
 - server setup [232](#)
 - settings [231](#)

- setup [231](#)
- severity levels [231](#)
- system information [69](#)
- system log [229](#)
- system reboot [211](#)

T

- tagged VLAN [81](#)
- Telnet
 - commands [254](#)
 - logging in [254](#)
 - management [254](#)
- temperature indicator [70](#)
- time
 - current [73](#)
 - time zone [73](#)
- Time (RFC-868) [73](#)
- time server [73](#)
- time service protocol [73](#)
 - format [73](#)
- Time To Live (TTL) [185](#)
- trademarks [1](#)
- transceiver
 - installation [41](#)
 - removal [42](#)
- traps
 - destination [218](#)
- traps, SNMP [217](#)
- trunk group [113](#)
- trunking [113](#)
- tunnel protocol attribute [120](#)
- Type of Service (ToS) [189](#)

U

- user mode [256](#)
 - examples [291](#)

V

- Vendor Specific Attribute See VSA
- ventilation [35](#)
- ventilation holes [35](#)
- VID [77](#), [81](#), [84](#), [85](#), [149](#)
 - number of possible VIDs [81](#)

- priority frame [81](#)
- VID (VLAN Identifier) [81](#)
- virtual links [178](#)
- virtual links, and OSPF [170](#)
- Virtual Router
 - status [201](#)
- Virtual Router (VR) [199](#)
- Virtual Router Redundancy Protocol (VRRP) [199](#)
- VLAN [73](#), [81](#)
 - acceptable frame type [88](#)
 - automatic registration [82](#)
 - ID [81](#)
 - ingress filtering [88](#)
 - introduction [73](#)
 - number of VLANs [84](#)
 - port isolation [88](#)
 - port number [85](#)
 - port settings [87](#)
 - port-based VLAN [88](#)
 - port-based, all connected [92](#)
 - port-based, isolation [92](#)
 - port-based, wizard [92](#)
 - static VLAN [85](#)
 - status [84](#), [85](#)
 - tagged [81](#)
 - trunking [83](#), [88](#)
 - type [74](#), [83](#)
- VLAN (Virtual Local Area Network) [73](#)
- VLAN commands examples [319](#)
- VLAN number [77](#)
- VLAN stacking [147](#), [149](#)
 - configuration [150](#)
 - example [147](#)
 - frame format [149](#)
 - port roles [148](#), [151](#)
 - priority [149](#)
- VRID (Virtual Router ID) [201](#)
- VRRP [199](#)
 - advertisement interval [203](#)
 - authentication [202](#)
 - backup router [199](#)
 - configuration example [205](#)
 - Hello message [203](#)
 - how it works [199](#)
 - interface setup [201](#)
 - master router [199](#)
 - network example [199](#), [205](#)
 - parameters [203](#)
 - preempt mode [203](#), [204](#)
 - priority [203](#), [204](#)
 - status [200](#)
 - uplink gateway [204](#)
 - uplink status [201](#)
 - Virtual Router [199](#)
 - Virtual Router ID [204](#)
 - VRID [201](#)

VSA [119](#), [120](#)
and port authentication [120](#)

W

warnings [4](#)
warranty [6](#)
 note [6](#)
web configurator [47](#)
 getting help [55](#)
 home [48](#)
 login [47](#)
 logout [55](#)
 navigation panel [49](#)
 screen summary [50](#)
weight, queuing [143](#)
Weighted Round Robin Scheduling (WRR) [143](#)
WRR (Weighted Round Robin Scheduling) [143](#)

Z

ZyNOS (ZyXEL Network Operating System) [213](#)