

Dimension ***ES-3124***

Ethernet Switch

December 2004

Version 3.50(TP.0)

User's Guide

ZyXEL
Unleash Networking Power

Copyright

Copyright © 2004 by ZyXEL Communications Corporation

The contents of this publication may not be reproduced in any part or as a whole, transcribed, stored in a retrieval system, translated into any language, or transmitted in any form or by any means, electronic, mechanical, magnetic, optical, chemical, photocopying, manual, or otherwise, without the prior written permission of ZyXEL Communications Corporation.

Published by ZyXEL Communications Corporation. All rights reserved.

Disclaimer

ZyXEL does not assume any liability arising out of the application or use of any products, or software described herein. Neither does it convey any license under its patent rights nor the patents rights of others. ZyXEL further reserves the right to make changes in any products described herein without notice. This publication is subject to change without notice.

Trademarks

Trademarks mentioned in this publication are used for identification purposes only and may be properties of their respective owners.

ZyXEL Limited Warranty

ZyXEL warrants to the original end user (purchaser) that this product is free from any defects in materials or workmanship for a period of up to two (2) years from the date of purchase. During the warranty period and upon proof of purchase, should the product have indications of failure due to faulty workmanship and/or materials, ZyXEL will, at its discretion, repair or replace the defective products or components without charge for either parts or labor and to whatever extent it shall deem necessary to restore the product or components to proper operating condition. Any replacement will consist of a new or re-manufactured functionally equivalent product of equal value, and will be solely at the discretion of ZyXEL. This warranty shall not apply if the product is modified, misused, tampered with, damaged by an act of God, or subjected to abnormal working conditions.

Note

Repair or replacement, as provided under this warranty, is the exclusive remedy of the purchaser. This warranty is in lieu of all other warranties, express or implied, including any implied warranty of merchantability or fitness for a particular use or purpose. ZyXEL shall in no event be held liable for indirect or consequential damages of any kind of character to the purchaser.

To obtain the services of this warranty, contact ZyXEL's Service Center for your Return Material Authorization number (RMA). Products must be returned Postage Prepaid. It is recommended that the unit be insured when shipped. Any returned products without proof of purchase or those with an out-dated warranty will be repaired or replaced (at the discretion of ZyXEL) and the customer will be billed for parts and labor. All repaired or replaced products will be shipped by ZyXEL to the corresponding return address, Postage Paid. This warranty gives you specific legal rights, and you may also have other rights that vary from country to country.

Interference Statements and Warnings

FCC Interference Statement

This switch complies with Part 15 of the FCC rules. Operation is subject to the following two conditions:

- (1) This switch may not cause harmful interference.
- (2) This switch must accept any interference received, including interference that may cause undesired operations.

FCC Warning

This equipment has been tested and found to comply with the limits for a Class A digital switch, pursuant to Part 15 of the FCC Rules. These limits are designed to provide reasonable protection against harmful interference in a commercial environment. This equipment generates, uses, and can radiate radio frequency energy and, if not installed and used in accordance with the instruction manual, may cause harmful interference to radio communications. Operation of this equipment in a residential area is likely to cause harmful interference in which case the user will be required to correct the interference at his own expense.

CE Mark Warning:

This is a class A product. In a domestic environment this product may cause radio interference in which case the user may be required to take adequate measures.

Taiwanese BSMI (Bureau of Standards, Metrology and Inspection) A Warning:

警告使用者

這是甲類的資訊產品, 在居住的環境使用時,
可能造成射頻干擾, 在這種情況下,
使用者會被要求採取某些適當的對策.

Certifications

Go to www.zyxel.com

Select your product from the drop-down list box on the ZyXEL home page to go to that product's page.

Select the certification you wish to view from this page.

Registration

Register your product online for free future product updates and information at www.zyxel.com for global products, or at www.us.zyxel.com for North American products.

Customer Support

If you have questions about your ZyXEL product or desire assistance, contact ZyXEL Communications Corporation offices worldwide, in one of the following ways:

Contacting Customer Support

When you contact your customer support representative, have the following information ready:

- ◆ Product model and serial number.
- ◆ Firmware version information.
- ◆ Warranty information.
- ◆ Date you received your product.
- ◆ Brief description of the problem and the steps you took to solve it.

METHOD LOCATION	SUPPORT E-MAIL SALES E-MAIL	TELEPHONE ¹ FAX ¹	WEB SITE FTP SITE	REGULAR MAIL
WORLDWIDE	support@zyxel.com.tw sales@zyxel.com.tw	+886-3-578-3942 +886-3-578-2439	www.zyxel.com www.europe.zyxel.com ftp.zyxel.com ftp.europe.zyxel.com	ZyXEL Communications Corp. 6 Innovation Road II Science Park Hsinchu 300 Taiwan
NORTH AMERICA	support@zyxel.com sales@zyxel.com	+1-800-255-4101 +1-714-632-0882 +1-714-632-0858	www.us.zyxel.com ftp.us.zyxel.com	ZyXEL Communications Inc. 1130 N. Miller St. Anaheim CA 92806-2001 U.S.A.
GERMANY	support@zyxel.de sales@zyxel.de	+49-2405-6909-0 +49-2405-6909-99	www.zyxel.de	ZyXEL Deutschland GmbH. Adenauerstr. 20/A2 D-52146 Wuerselen Germany
FRANCE	info@zyxel.fr	+33 (0)4 72 52 97 97 +33 (0)4 72 52 19 20	www.zyxel.fr	ZyXEL France 1 rue des Vergers Bat. 1 / C 69760 Limonest France
SPAIN	support@zyxel.es sales@zyxel.es	+34 902 195 420 +34 913 005 345	www.zyxel.es	ZyXEL Communications Alejandro Villegas 33 1º, 28043 Madrid Spain
DENMARK	support@zyxel.dk sales@zyxel.dk	+45 39 55 07 00 +45 39 55 07 07	www.zyxel.dk	ZyXEL Communications A/S Columbusvej 5 2860 Soeborg Denmark
NORWAY	support@zyxel.no sales@zyxel.no	+47 22 80 61 80 +47 22 80 61 81	www.zyxel.no	ZyXEL Communications A/S Nils Hansens vei 13 0667 Oslo Norway
SWEDEN	support@zyxel.se sales@zyxel.se	+46 31 744 7700 +46 31 744 7701	www.zyxel.se	ZyXEL Communications A/S Sjöporten 4, 41764 Göteborg Sweden
FINLAND	support@zyxel.fi sales@zyxel.fi	+358-9-4780-8411 +358-9-4780 8448	www.zyxel.fi	ZyXEL Communications Oy Malminkaari 10 00700 Helsinki Finland

¹ “+” is the (prefix) number you enter to make an international telephone call.

Table of Contents

Copyright.....	ii
ZyXEL Limited Warranty	iii
Interference Statements and Warnings	iv
Customer Support	v
Preface.....	xviii
Chapter 1 Getting to Know the ES-3124	1-1
1.1 Features	1-1
1.1.1 Hardware Features.....	1-1
1.1.2 Firmware Features.....	1-2
1.2 Applications	1-3
1.2.1 Backbone Application.....	1-3
1.2.2 Bridging Example	1-4
1.2.3 High Performance Switched Workgroup Example	1-5
1.2.4 IEEE 802.1Q VLAN Application Examples.....	1-5
Chapter 2 Hardware Installation.....	2-1
2.1 Installation Scenarios	2-1
2.1.1 Desktop Installation Procedure	2-1
2.1.2 Rack-Mounted Installation.....	2-2
Chapter 3 Hardware Connections	3-1
3.1 Safety Warnings	3-1
3.2 Front Panel.....	3-1
3.2.1 Console Port.....	3-2
3.2.2 Ethernet Ports	3-2
3.2.3 Gigabit Ports.....	3-2
3.2.4 Mini GBIC Slots	3-3
3.2.5 Management Port	3-5
3.3 Rear Panel.....	3-5
3.3.1 Power Connector.....	3-6
3.3.2 External Backup Power Supply Connector.....	3-6
3.4 Front Panel LEDs	3-6
3.5 Stacking Scenario Examples	3-8
3.6 Uplink Scenario Example	3-9
3.7 Configuring the ES-3124	3-10
Chapter 4 Introducing the Web Configurator.....	4-1
4.1 Introduction.....	4-1
4.2 System Login.....	4-1
4.3 Status Screen	4-2
4.3.1 Change Your Password	4-5
4.4 Switch Lockout	4-6
4.5 Resetting the Switch.....	4-6
4.5.1 Reload the Configuration file.....	4-7
4.5.2 Reset to the Factory Defaults	4-8
4.5.3 Logging Out of the Web Configurator	4-8

4.5.4	Help	4-9
Chapter 5	System Status and Port Details.....	5-1
5.1	About System Statistics and Information.....	5-1
5.2	Port Status Summary.....	5-1
5.2.1	Port Details	5-2
Chapter 6	Basic Setting.....	6-1
6.1	Introducing The Basic Setting Screens	6-1
6.2	System Information.....	6-1
6.3	General Setup.....	6-3
6.4	Introduction to VLANs.....	6-6
6.5	IGMP Snooping	6-6
6.6	Switch Setup Screen	6-6
6.7	IP Setup	6-9
6.8	Port Setup.....	6-10
Chapter 7	VLAN.....	7-1
7.1	Introduction to IEEE 802.1Q Tagged VLAN.....	7-1
7.1.1	Forwarding Tagged and Untagged Frames	7-1
7.1.2	Automatic VLAN Registration.....	7-1
7.1.3	Port VLAN Trunking	7-3
7.2	802.1Q VLAN.....	7-3
7.2.1	802.1Q VLAN Port Settings.....	7-5
7.2.2	802.1Q Static VLAN.....	7-6
7.2.3	Viewing and Editing VLAN Settings.....	7-8
7.3	Introduction to Port-based VLANs.....	7-10
7.3.1	Configuring a Port-based VLAN.....	7-10
Chapter 8	Static MAC Forward Setup.....	8-1
8.1	Introduction to Static MAC Forward Setup	8-1
8.2	Configuring Static MAC Forwarding	8-1
8.3	Viewing and Editing Static MAC Forwarding Rules.....	8-2
Chapter 9	Filtering	9-1
9.1	Introduction to Filtering	9-1
9.2	Configuring a Filtering Rule.....	9-1
9.3	Viewing and Editing Filter Rules	9-2
Chapter 10	Spanning Tree Protocol.....	10-1
10.1	Introduction to Spanning Tree Protocol (STP).....	10-1
10.1.1	STP Terminology	10-1
10.1.2	How STP Works.....	10-1
10.1.3	STP Port States.....	10-2
10.2	STP Status.....	10-2
10.2.1	Configuring STP.....	10-4
Chapter 11	Bandwidth Control	11-1
11.1	Introduction to Bandwidth Control	11-1
Chapter 12	Broadcast Storm Control.....	12-1
12.1	Introducing Broadcast Storm Control.....	12-1
12.2	Configuring Broadcast Storm Control.....	12-1

Chapter 13	Mirroring	13-1
13.1	Introduction to Port Mirroring.....	13-1
13.2	Port Mirroring Configuration.....	13-1
Chapter 14	Link Aggregation	14-1
14.1	Introduction to Link Aggregation.....	14-1
14.1.1	Dynamic Link Aggregation.....	14-1
14.1.2	Link Aggregation ID.....	14-1
14.2	Link Aggregation Protocol Status.....	14-2
14.3	Link Aggregation Setup.....	14-3
Chapter 15	Port Authentication	15-1
15.1	Introduction to Authentication.....	15-1
15.1.1	RADIUS.....	15-1
15.2	Configuring Port Authentication.....	15-1
15.2.1	Configuring RADIUS Server Settings.....	15-2
15.2.2	Configuring IEEE802.1x.....	15-2
Chapter 16	Port Security	16-1
16.1	About Port Security.....	16-1
16.2	Port Security Setup.....	16-1
Chapter 17	Access Control	17-1
17.1	About Access Control.....	17-1
17.2	Access Control Overview.....	17-1
17.3	About SNMP.....	17-2
17.3.1	Supported MIBs.....	17-3
17.3.2	SNMP Traps.....	17-3
17.3.3	Configuring SNMP.....	17-3
17.3.4	Setting Up Login Accounts.....	17-4
17.4	Service Access Control.....	17-6
17.5	Remote Management.....	17-6
Chapter 18	Queuing Method	18-1
18.1	Introduction to Queuing.....	18-1
18.1.1	Strictly Priority.....	18-1
18.1.2	Weighted Fair Scheduling.....	18-1
18.2	Configuring Queuing.....	18-1
Chapter 19	Classifier	19-1
19.1	About the Classifier and QoS.....	19-1
19.2	Configuring the Classifier.....	19-1
19.3	Viewing and Editing Classifier Configuration.....	19-4
19.4	Classifier Example.....	19-5
Chapter 20	Policy Rule	20-1
20.1	About Policy Rules.....	20-1
20.1.1	DiffServ.....	20-1
20.1.2	DSCP and Per-Hop Behavior.....	20-1
20.2	Configuring Policy Rules.....	20-1
20.3	Viewing and Editing Policy Configuration.....	20-4
20.4	Policy Example.....	20-5

Chapter 21	VLAN Stacking	21-1
21.1	Introduction.....	21-1
21.1.1	VLAN Stacking Example.....	21-1
21.2	VLAN Stacking Roles.....	21-2
21.3	VLAN Tag Format.....	21-2
21.3.1	Frame Format.....	21-3
21.4	Configuring VLAN Stacking.....	21-3
Chapter 22	Routing Protocol	22-1
22.1	Static Route.....	22-1
Chapter 23	Maintenance	23-1
23.1	Maintenance.....	23-1
23.2	Firmware Upgrade.....	23-1
23.3	Restore a Configuration File.....	23-2
23.4	Backing Up a Configuration File.....	23-2
23.5	Load Factory Defaults.....	23-3
23.6	Reboot System.....	23-3
23.7	Command Line FTP.....	23-4
23.7.1	Filename Conventions.....	23-4
23.7.2	FTP Command Line Procedure.....	23-4
23.7.3	GUI-based FTP Clients.....	23-5
23.7.4	FTP over WAN Restrictions.....	23-5
Chapter 24	Diagnostic	24-1
24.1	Diagnostic.....	24-1
Chapter 25	Cluster Management	25-1
25.1	Introduction to Cluster Management.....	25-1
25.2	Cluster Management Status.....	25-2
25.2.1	Cluster Member Switch Management.....	25-3
25.3	Configuring Cluster Management.....	25-4
Chapter 26	MAC Table	26-1
26.1	Introduction to MAC Table.....	26-1
26.2	Viewing MAC Table.....	26-2
Chapter 27	ARP Table	27-1
27.1	Introduction to ARP Table.....	27-1
27.1.1	How ARP Works.....	27-1
27.2	Viewing ARP Table.....	27-1
Chapter 28	Introduction to CLI	28-1
28.1	Command Line Interface Overview.....	28-1
28.1.1	Accessing the Command Line Interface.....	28-1
28.1.2	Command Conventions.....	28-1
28.1.3	Command Syntax Conventions.....	28-2
28.1.4	Getting Help.....	28-2
28.2	Command Summary.....	28-2
28.2.1	sys Commands.....	28-2
28.2.2	sys sw Commands.....	28-6
28.2.3	exit Command.....	28-14

28.2.4	ip Commands	28-14
28.2.5	ether Command	28-17
28.2.6	config Command	28-17
Chapter 29	Command Examples	29-1
29.1	Commonly Used Commands Overview	29-1
29.2	sys Commands	29-1
29.2.1	sys log disp	29-1
29.2.2	sys log clear	29-1
29.2.3	sys version	29-1
29.2.4	sys monitor status	29-2
29.2.5	sys sw vlan1q vlan list	29-2
29.3	sys cluster Commands	29-3
29.3.1	sys cluster status	29-3
29.3.2	sys cluster showMember	29-3
29.3.3	sys cluster showCandidate	29-4
29.4	ip Commands	29-4
29.4.1	ip ping	29-5
29.4.2	ip route status	29-5
29.4.3	ip arp status	29-5
29.4.4	ip dhcp Commands	29-6
29.5	Enabling rstp on the Stacking Ports	29-6
Chapter 30	IEEE 802.1Q Tagged VLAN Commands	30-1
30.1	IEEE 802.1Q Tagged VLAN Overview	30-1
30.2	Filtering Databases	30-1
30.2.1	Static Entries (SVLAN Table)	30-1
30.2.2	Dynamic Entries (DVLAN Table)	30-1
30.3	Configuring Tagged VLAN	30-1
30.4	IEEE VLAN1Q Tagged VLAN Configuration Commands	30-3
30.4.1	garp status	30-3
30.4.2	garp timer	30-3
30.4.3	gvrp status	30-4
30.4.4	gvrp enable	30-4
30.4.5	gvrp disable	30-4
30.4.6	vlan1q port status	30-4
30.4.7	vlan1q port default vid	30-5
30.4.8	vlan1q port accept	30-5
30.4.9	vlan1q port gvrp	30-6
30.4.10	vlan1q svlan cpu	30-6
30.4.11	vlan1q svlan setentry	30-6
30.4.12	vlan1q svlan delentry	30-8
30.5	vlan1q svlan active	30-8
30.6	vlan1q svlan inactive	30-8
30.7	vlan1q svlan list	30-8
30.8	vlan1q vlan list	30-9
30.8.1	vlan1q vlan status	30-9

Dimension ES-3124 Ethernet Switch

A	Product Specifications	A-1
B	Index	B-1

List of Figures

Figure 1-1 Backbone Application.....	1-4
Figure 1-2 Bridging Application	1-4
Figure 1-3 High Performance Switched Workgroup Application.....	1-5
Figure 1-4 VLAN Workgroup Application.....	1-6
Figure 1-5 Shared Server Using VLAN Example	1-6
Figure 2-1 Attaching Rubber Feet	2-1
Figure 2-2 Attaching Mounting Brackets and Screws	2-2
Figure 2-3 Mounting the ES to an EIA standard 19-inch rack	2-2
Figure 3-1 ES-3124 Front Panel.....	3-1
Figure 3-2 Transceiver Installation Example.....	3-4
Figure 3-3 Installed Transceiver.....	3-4
Figure 3-4 Opening the Transceiver's Latch Example	3-5
Figure 3-5 Transceiver Removal Example	3-5
Figure 3-6 ES-3124 Rear Panel.....	3-6
Figure 3-7 Front Panel LEDs	3-6
Figure 3-8 Stacking Example 1	3-8
Figure 3-9 Stacking Example 2	3-8
Figure 3-10 Stacking Example 3	3-9
Figure 3-11 Uplink Example	3-10
Figure 4-1 Web Configurator: login	4-1
Figure 4-2 Web Configurator Home Screen (Status).....	4-2
Figure 4-3 Web Configurator: Change Password at Login.....	4-6
Figure 4-4 Reload the Configuration file: Via Console Port	4-8
Figure 4-5 Reset the Switch: Via Console Port	4-8
Figure 4-6 Web Configurator: Logout Screen	4-9
Figure 5-1 Port Status Summary	5-1
Figure 5-2 Status: Port Details	5-3
Figure 6-1 System Info.....	6-2
Figure 6-2 General Setup	6-4
Figure 6-3 Switch Setup.....	6-7
Figure 6-4 IP Setup.....	6-9
Figure 6-5 Port Setup	6-11
Figure 7-1 Port VLAN Trunking.....	7-3
Figure 7-2 Selecting a VLAN Type.....	7-3
Figure 7-3 802.1Q VLAN Status.....	7-4
Figure 7-4 802.1Q VLAN Port Settings.....	7-5
Figure 7-5 802.1Q Static VLAN	7-7
Figure 7-6 Static VLAN: Summary Table.....	7-8
Figure 7-7 VID1 Example Screen	7-9
Figure 7-8 Port Based VLAN Setup (All Connected).....	7-11
Figure 7-9 Port Based VLAN Setup (Port isolation).....	7-12
Figure 8-1 Static MAC Forwarding.....	8-1
Figure 8-2 Static MAC Forwarding: Summary Table	8-2

Figure 9-1 Filtering	9-1
Figure 9-2 Filtering: Summary Table	9-2
Figure 10-1 Spanning Tree Protocol: Status	10-3
Figure 10-2 Spanning Tree Protocol: Configuring	10-5
Figure 11-1 Bandwidth Control	11-1
Figure 12-1 Broadcast Storm Control	12-2
Figure 13-1 Mirroring	13-2
Figure 14-1 Aggregation ID	14-2
Figure 14-2 Link Aggregation: Link Aggregation Protocol Status	14-2
Figure 14-3 Link Aggregation: Configuration	14-4
Figure 15-1 RADIUS Server	15-1
Figure 15-2 Port Authentication	15-2
Figure 15-3 Port Authentication: RADIUS	15-2
Figure 15-4 Port Authentication: 802.1x	15-3
Figure 16-1 Port Security	16-2
Figure 17-1 Access Control	17-1
Figure 17-2 Console Port Priority	17-1
Figure 17-3 SNMP Management Model	17-2
Figure 17-4 Access Control: SNMP	17-4
Figure 17-5 Access Control: Logins	17-5
Figure 17-6 Access Control: Service Access Control	17-6
Figure 17-7 Access Control: Remote Management	17-7
Figure 18-1 Queuing Method	18-2
Figure 19-1 Classifier	19-2
Figure 19-2 Classifier: Summary Table	19-4
Figure 19-3 Classifier: Example	19-6
Figure 20-1 Policy	20-2
Figure 20-2 Policy: Summary Table	20-4
Figure 20-3 Policy Example	20-6
Figure 21-1 VLAN Stacking Example	21-2
Figure 21-2 VLAN Stacking	21-4
Figure 22-1 Static Routing	22-1
Figure 22-2 Static Routing: Summary Table	22-2
Figure 23-1 Maintenance	23-1
Figure 23-2 Firmware Upgrade	23-1
Figure 23-3 Restore Configuration	23-2
Figure 23-4 Backup Configuration	23-2
Figure 23-5 Confirm Load factory Defaults	23-3
Figure 23-6 Restart Switch After Load Factory Defaults	23-3
Figure 23-7 Confirm Restart The Switch	23-3
Figure 24-1 Diagnostic	24-1
Figure 25-1 Clustering Application Example	25-1
Figure 25-2 Cluster Management Status	25-2
Figure 25-3 Cluster Member Web Configurator Screen	25-3
Figure 25-4 Example: Uploading Firmware to a Cluster Member Switch	25-4

Figure 25-5 Configuring Cluster Management	25-5
Figure 26-1 MAC Table Flowchart	26-1
Figure 26-2 MAC Table	26-2
Figure 27-1 ARP Table	27-2
Figure 28-1 CLI Help: Sample Output	28-2
Figure 29-1 sys log disp Command Example	29-1
Figure 29-2 sys version Command Example	29-2
Figure 29-3 sys monitor status Command Example	29-2
Figure 29-4 sys sw vlan1q vlan list Command Example	29-2
Figure 29-5 sys cluster status Command Example	29-3
Figure 29-6 sys cluster showMember Command Example	29-4
Figure 29-7 sys cluster status Command Example	29-4
Figure 29-8 IP PING Command Example	29-5
Figure 29-9 ip route status Command Example	29-5
Figure 29-10 ip arp status Command Example	29-5
Figure 29-11 ip dhcp Command Examples	29-6
Figure 30-1 Tagged VLAN Configuration and Activation Example	30-2
Figure 30-2 CPU VLAN Configuration and Activation Example	30-2
Figure 30-3 Deleting Default VLAN Example	30-3
Figure 30-4 GARP STATUS Command Example	30-3
Figure 30-5 garp timer Command Example	30-4
Figure 30-6 garp status Command Example	30-4
Figure 30-7 vlan1q port status Command Example	30-5
Figure 30-8 vlan1q port default vid Command Example	30-5
Figure 30-9 vlan1q port accept Command Example	30-5
Figure 30-10 vlan1q port gvrp Command Example	30-6
Figure 30-11 vlan1q svlan cpu Command Example	30-6
Figure 30-12 Modifying the Static VLAN Example	30-7
Figure 30-13 vlan1q svlan delentry Command Example	30-8
Figure 30-14 vlan1q svlan list Command Example	30-9
Figure 30-15 vlan1q svlan list Command Example	30-9
Figure 30-16 vlan1q vlan status Command Example	30-10

List of Charts

Chart 1 General Product Specifications	A-1
Chart 2 Performance and Management Specifications	A-2
Chart 3 Physical and Environmental Specifications	A-3

List of Tables

Table 3-1 ES-3124: Front Panel Ports	3-1
Table 3-2 ES-3124: LED Descriptions.....	3-6
Table 4-1 Navigation Panel Sub-links Overview	4-3
Table 4-2 Web Configurator Screen Sub-links Details.....	4-3
Table 4-3 Navigation Panel Sub-link Descriptions	4-4
Table 5-1 Status.....	5-2
Table 5-2 Status: Port Details.....	5-3
Table 6-1 System Info	6-2
Table 6-2 General Setup.....	6-4
Table 6-3 Switch Setup	6-7
Table 6-4 IP Setup.....	6-9
Table 6-5 Port Setup.....	6-12
Table 7-1 GARP Terminology.....	7-2
Table 7-2 802.1Q VLAN Status.....	7-4
Table 7-3 802.1Q VLAN Port Settings	7-6
Table 7-4 802.1Q Static VLAN.....	7-8
Table 7-5 Static VLAN: Summary Table	7-8
Table 7-6 Port Based VLAN Setup.....	7-13
Table 8-1 Static MAC Forwarding.....	8-1
Table 8-2 Static MAC Forwarding: Summary Table.....	8-2
Table 9-1 Filtering.....	9-1
Table 9-2 Filtering: Summary Table	9-2
Table 10-1 STP Path Costs.....	10-1
Table 10-2 STP Port States.....	10-2
Table 10-3 Spanning Tree Protocol: Status	10-3
Table 10-4 Spanning Tree Protocol: Configuring	10-6
Table 11-1 Bandwidth Control.....	11-2
Table 12-1 Broadcast Storm Control.....	12-2
Table 13-1 Mirroring.....	13-3
Table 14-1 Link Aggregation: Link Aggregation Protocol Status.....	14-3
Table 14-2 Link Aggregation: Configuration.....	14-5
Table 15-1 Port Authentication: RADIUS.....	15-2
Table 15-2 Port Authentication: 802.1x	15-4
Table 16-1 Port Security.....	16-3
Table 17-1 Access Control Summary.....	17-2
Table 17-2 SNMP Commands.....	17-3
Table 17-3 SNMP Traps.....	17-3
Table 17-4 Access Control: SNMP	17-4
Table 17-5 Access Control: Logins	17-5
Table 17-6 Access Control: Service Access Control	17-6
Table 17-7 Access Control: Remote Management	17-7
Table 18-1 Queuing Method	18-3
Table 19-1 Classifier	19-2

Table 19-2 Classifier: Summary Table	19-4
Table 19-3 Common Ethernet Types and Protocol Number	19-4
Table 19-4 Common IP Ports	19-5
Table 20-1 Policy	20-3
Table 20-2 Policy: Summary Table	20-5
Table 21-1 VLAN Stacking	21-4
Table 22-1 Static Routing	22-1
Table 22-2 Static Routing: Summary Table	22-2
Table 23-1 Filename Conventions	23-4
Table 23-2 General Commands for GUI-based FTP Clients	23-5
Table 24-1 Diagnostic	24-1
Table 25-1 Clustering Management Specifications	25-1
Table 25-2 Cluster Management Status	25-2
Table 25-3 FTP Upload to Cluster member Example	25-4
Table 25-4 Configuring Cluster Management	25-5
Table 26-1 MAC Table	26-2
Table 27-1 ARP Table	27-2
Table 28-1 Command Summary: sys	28-2
Table 28-2 Command Summary: sys sw	28-6
Table 28-3 Command Summary: exit	28-14
Table 28-4 Command Summary: ip	28-14
Table 28-5 Command Summary: ether	28-17
Table 28-6 Command Summary: config	28-17

Preface

Congratulations on your purchase from the Dimension series of Ethernet switches.

This preface introduces you to the ES-3124 and discusses the conventions of this User's Guide. It also provides information on other related documentation.

About the ES-3124

The ES-3124 Ethernet switch is a managed switch with features ideally suited in any environment with unshielded twisted pair (UTP) wiring. It can deliver broadband IP services to:

- Multi-tenant unit (MTU) buildings (hotels, motels, resorts, residential multi-dwelling units, office buildings, educational establishments, etc.)
- Public facilities (convention centers, airports, plazas, train stations, etc.)
- Enterprises.

It can also be deployed as a mini-POP (point-of-presence) in a building basement delivering 10/100Mbps data service over Category 5 wiring to each customer.

General Syntax Conventions

- This guide shows you how to configure the switch using the web configurator and CLI commands. See the online HTML help for information on individual web configurator screens.
- Mouse action sequences are denoted using a comma. For example, click **Start, Settings, Control Panel, Network** means first you click **Start**, click or move the mouse pointer over **Settings**, then click or move the mouse pointer over **Control Panel** and finally click (or double-click) **Network**.
- "Enter" means for you to type one or more characters. "Select" or "Choose" means for you to use one of the predefined choices.
- Predefined choices are in **Bold Arial** font.
- Button and field labels, links and screen names in are in **Bold Times New Roman** font.
- For brevity's sake, we will use "e.g." as shorthand for "for instance", and "i.e." as shorthand for "that is" or "in other words" throughout this manual.

Related Documentation

Web Configurator Online HTML help

The online HTML help shows you how to use the web configurator to configure individual screens. More background information can be found in this UG.

ZyXEL Web Site

The ZyXEL download library at www.zyxel.com contains additional support documentation as well as an online glossary of networking terms.







Naming Conventions

- The ES-3124 Ethernet Switch may be referred to as the ES-3124, the switch or, simply, as the device.
- This user's guide refers an Ethernet device as a switch in general for feature background information.

User Guide Feedback

Help us help you. E-mail all User Guide-related comments, questions or suggestions for improvement to techwriters@zyxel.com.tw or send regular mail to The Technical Writing Team, ZyXEL Communications Corp., 6 Innovation Road II, Science-Based Industrial Park, Hsinchu, 300, Taiwan. Thank you.

Graphics Icons Key

 ES-3124	 Switch	 VDSL Modem
 Computer	 Telephone	 Gateway

Firmware Naming Conventions

A firmware version includes the network operating system platform version, model code and release number as shown in the following example.

Firmware Version: V3.50(TP.0)
"V3.50" is the network operating system platform version.
"TP" is the model code.
"0" is this firmware's release number. This varies as new firmware is released. Your firmware's release number may not match what is displayed in this <i>User's Guide</i> .

Part I

Features and Applications

This part acquaints you with the features and applications of the ES-3124.

Chapter 1

Getting to Know the ES-3124

This chapter describes the key features, benefits and applications of the ES-3124.

The ES-3124 is a stand-alone layer 2 Ethernet switch with 24 10/100Mbps ports, two RJ-45 Gigabit (1Gbps or 1000Mbps)/mini GBIC (Gigabit Interface Converter) combo ports for uplink, two RJ-45 Gigabit ports for stacking and a console port and a management port for local management. A combo port contains one Gigabit port and one slot for mini GBIC transceiver (SPF module).

With its built-in web configurator, managing and configuring the switch is easy. From cabinet management to port-level control and monitoring, you can visually configure and manage your network via the web browser. Just click your mouse instead of typing cryptic command strings. In addition, the switch can also be managed via Telnet, the console port, or third-party SNMP management.

1.1 Features

The next two sections describe the hardware and firmware features of the ES-3124.

1.1.1 Hardware Features

Power

The ES-3124 requires 100~240VAC/1.5A power.

24 10/100 Mbps Fast Ethernet Ports

Connect up to 24 computers or switches to the 10/100Mbps auto-negotiating, automatic cable sensing (auto-MDIX) Ethernet RJ-45 ports. All Ethernet ports support:

- IEEE 802.3/3u/3z/3ab standards
- Back pressure flow control in half duplex mode
- IEEE 802.3x flow control in full duplex mode

Two Gigabit Ethernet Ports for Uplink Modules

The gigabit ports allow the ES-3124 to connect to another WAN switch or daisy-chain to other switches.

Two Slots for Mini GBIC Modules

The mini GBIC (Gigabit Interface Converter) module transceivers allow flexibility in connection options. You can use mini GBIC transceivers for fiber connections to backbone Ethernet switches.

Stacking

Up to eight switches may be stacked.

Console Port

Use the console port for local management of the switch.

Fans

The fans cool the ES-3124 sufficiently to allow reliable operation of the switch in even poorly ventilated rooms or basements.

1.1.2 Firmware Features

IP Protocols

- IP Host (No routing)
- Telnet for configuration and monitoring
- SNMP for management
 - SNMP MIB II (RFC 1213)
 - SNMP v1 RFC 1157
 - SNMPv2, SNMPv2c or later version, compliant with RFC 2011 SNMPv2 MIB for IP, RFC 2012 SNMPv2 MIB for TCP, RFC 2013 SNMPv2 MIB for UDP
 - Ethernet MIBs RFC 1643
 - Bridge MIBs RFC 1493
 - SMI RFC 1155
 - RMON RFC 1757
 - SNMPv2, SNMPv2c RFC 2674

Management

- Web configurator
- Command-line interface locally via console port or remotely via Telnet
- SNMP

System Monitoring

- System status (link status, rates, statistics counters)
- SNMP
- Temperatures, voltage, fan speed reports and alarms
- Port Mirroring allows you to analyze one port's traffic from another.

Security

- System management password protection
- IEEE 802.1Q VLAN
- Port-based VLAN
- 802.1x Authentication

- Limit dynamic port MAC address learning
- Static MAC address filtering

Port Link Aggregation

The ES-3124 adheres to the 802.3ad standard for static and dynamic port link aggregation.

Bandwidth Control

- The ES-3124 supports rate limiting in 1Mbps increments allowing you to create different service plans.
- The ES-3124 supports IGMP snooping enabling group multicast traffic to be only forwarded to ports that are members of that group; thus allowing you to significantly reduce multicast traffic passing through your switch.
- Broadcast storm control

Quality of Service

- Eight queues so you can ensure mission-critical data gets delivered on time.
- Follows the IEEE 802.1p priority setting standard based on source/destination MAC addresses.

STP (Spanning Tree Protocol) / RSTP (Rapid STP)

(R)STP detects and breaks network loops and provides backup links between switches, bridges or routers. It allows a switch to interact with other (R)STP-compliant switches in your network to ensure that only one path exists between any two stations on the network.

Cluster Management

Cluster Management allows you to manage switches through one switch, called the cluster manager. The switches must be directly connected and be in the same VLAN group so as to be able to communicate with one another using same cluster management implementation.

1.2 Applications

This section shows a few examples of using the ES-3124 in various network environments.

1.2.1 Backbone Application

In this application, the switch is an ideal solution for small networks where rapid growth can be expected in the near future.

The switch can be used standalone for a group of heavy traffic users. You can connect computers directly to the switch's port or connect other switches to the ES-3124.

In this example, all computers connected directly or indirectly to the ES-3124 can share super high-speed applications on the Gigabit server.

To expand the network, simply add more networking devices such as switches, routers, firewalls, print servers etc.

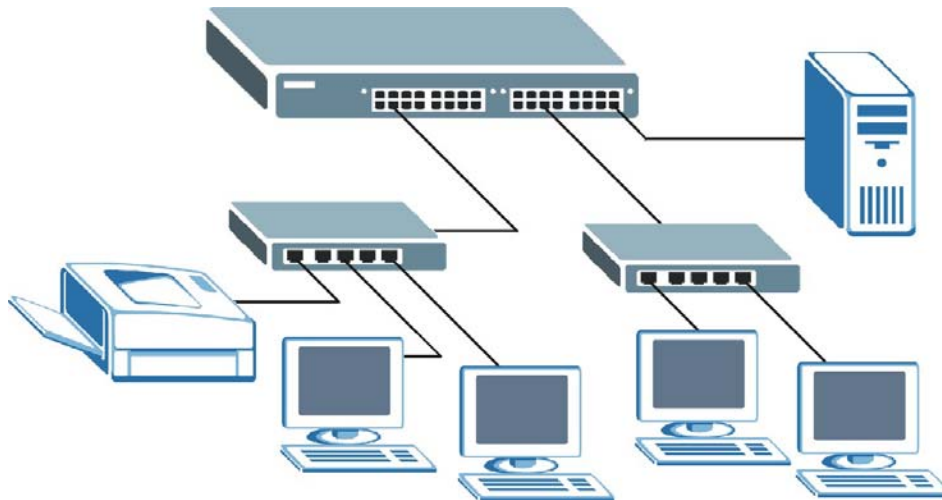

Figure 1-1 Backbone Application

1.2.2 Bridging Example

In this example application the switch is the ideal solution for different company departments to connect to the corporate backbone. It can alleviate bandwidth contention and eliminate server and network bottlenecks. All users that need high bandwidth can connect to high-speed department servers via the switch. You can provide a super-fast uplink connection by using an uplink port on the ES-3124.

Moreover, the switch eases supervision and maintenance by allowing network managers to centralize multiple servers at a single location.

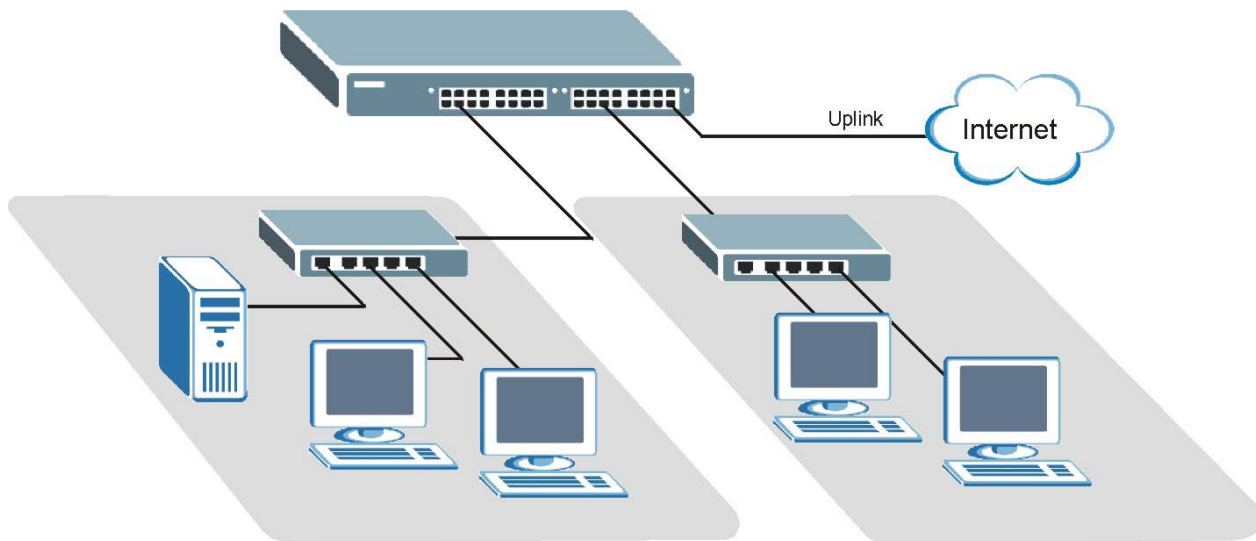

Figure 1-2 Bridging Application

Full-duplex mode operation only applies to point-to-point access (for example, when attaching the switch to a workstation, server, or another switch). When connecting to hubs, use a standard cascaded connection set at half-duplex operation.

1.2.3 High Performance Switched Workgroup Example

The switch is ideal for connecting two power workgroups that need high bandwidth. In the following example, use trunking to connect these two power workgroups.

Switching to higher-speed LANs such as FDDI or ATM is not feasible for most people due to the expense of replacing all existing Ethernet cables and adapter cards, restructuring your network and complex maintenance.

The ES-3124 can provide the same bandwidth as FDDI and ATM at much lower cost while still being able to use existing adapters and switches. Moreover, the current LAN structure can be retained as all ports can freely communicate with each other.

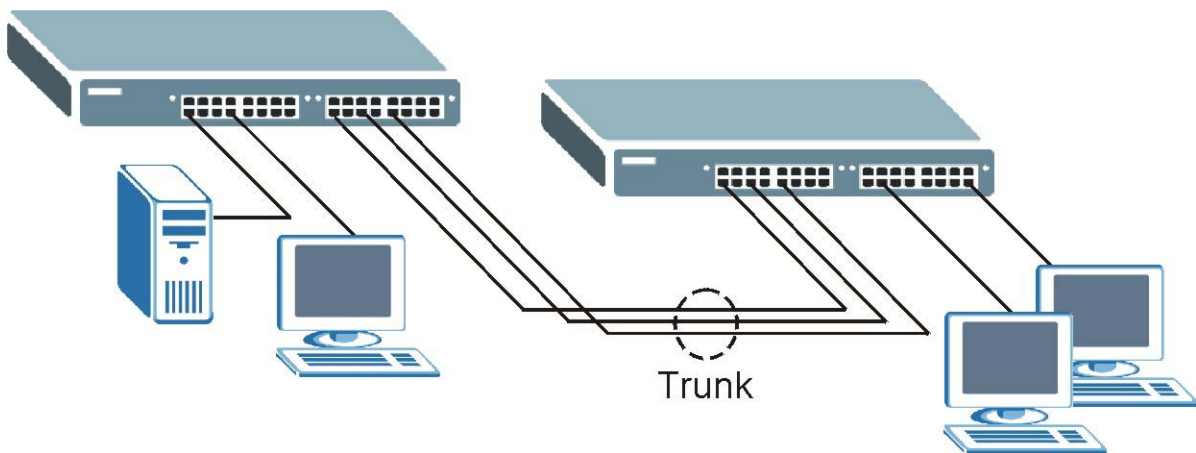

Figure 1-3 High Performance Switched Workgroup Application

1.2.4 IEEE 802.1Q VLAN Application Examples

This section shows a workgroup and a shared server example using 802.1Q tagged VLANs. For more information on VLANs, see the *Switch Setup* and *VLAN Setup* chapters in this User's Guide. A VLAN (Virtual Local Area Network) allows a physical network to be partitioned into multiple logical networks. Stations on a logical network belong to one group. A station can belong to more than one group. With VLAN, a station cannot directly talk to or hear from stations that are not in the same group(s) unless such traffic first goes through a router.

Tag-based VLAN Workgroup Example

Ports in the same VLAN group share the same broadcast domain thus increase network performance through reduced broadcast traffic. VLAN groups can be modified at any time by adding, moving or changing ports without any re-cabling.

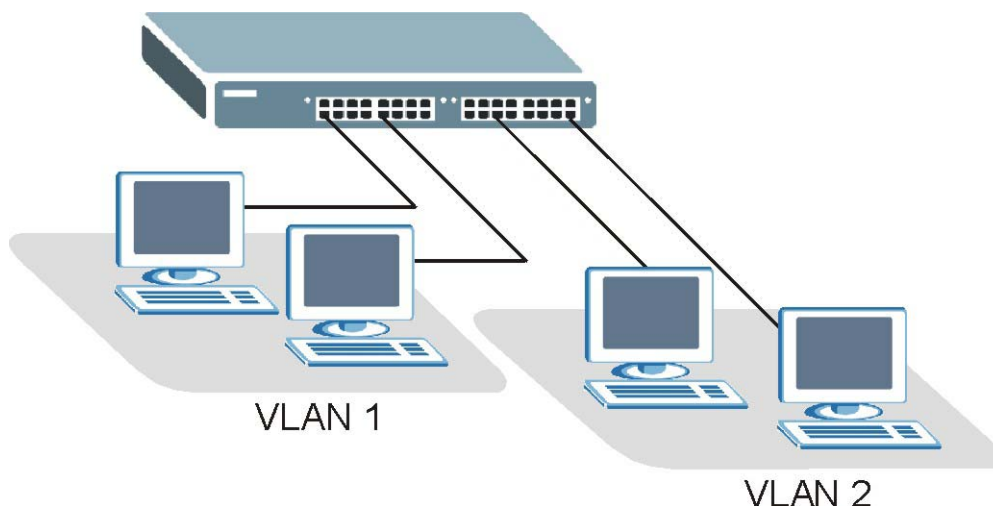

Figure 1-4 VLAN Workgroup Application

VLAN Shared Server Example

Shared resources such as a server can be used by all ports in the same VLAN as the server, as shown in the following example. In this example, only ports that need access to the server need belong to VLAN 3 while they can belong to other VLAN groups too.

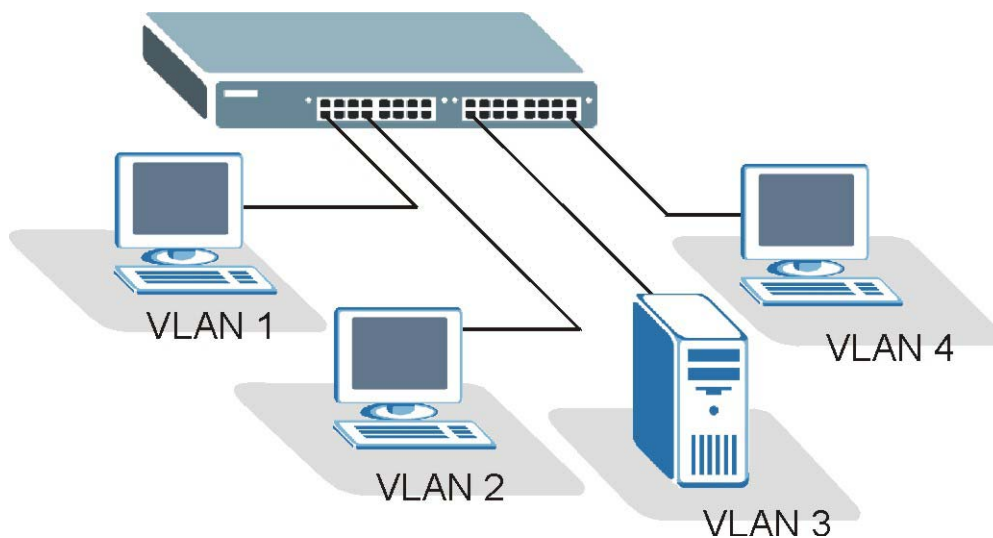

Figure 1-5 Shared Server Using VLAN Example

Part II

Hardware Installation & Connections

This part acquaints you with installation scenarios of the ES-3124, instructs you on how to make the hardware connections, shows some stacking/uplink examples and explains the front panel LEDs.

Chapter 2

Hardware Installation

This chapter shows two switch installation scenarios.

2.1 Installation Scenarios

The switch can be placed on a desktop or rack-mounted on a standard EIA rack. Use the rubber feet in a desktop installation and the brackets in a rack-mounted installation.

For proper ventilation, allow at least 4 inches (10 cm) of clearance at the front and 3.4 inches (8 cm) at the back of the switch. This is especially important for enclosed rack installations.

2.1.1 Desktop Installation Procedure

1. Make sure the switch is clean and dry.
2. Set the switch on a smooth, level surface strong enough to support the weight of the switch and the connected cables. Make sure there is a power outlet nearby.
3. Make sure there is enough clearance around the switch to allow air circulation and the attachment of cables and the power cord.
4. Remove the adhesive backing from the rubber feet.
5. Attach the rubber feet to each corner on the bottom of the switch. These rubber feet help protect the switch from shock or vibration and ensure space between switches when stacking.

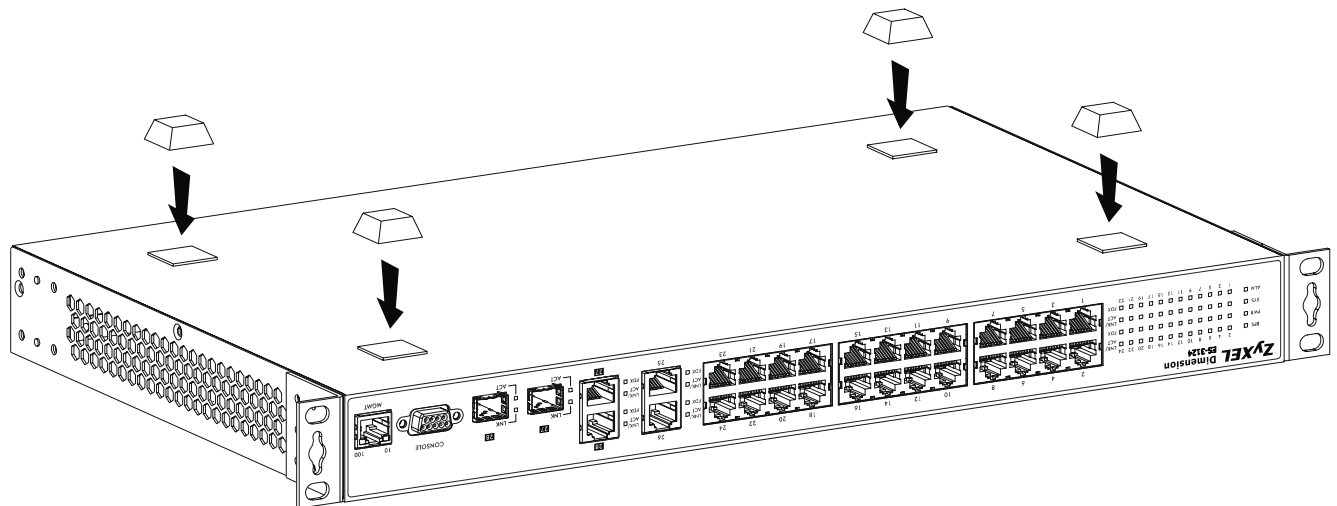

Figure 2-1 Attaching Rubber Feet

Do not block the ventilation holes. Leave space between switches when stacking.

2.1.2 Rack-Mounted Installation

The switch can be mounted on an EIA standard size, 19-inch rack or in a wiring closet with other equipment. Follow the steps below to mount your switch on a standard EIA rack using a rack-mounting kit.

1. Align one bracket with the holes on one side of the switch and secure it with the bracket screws smaller than the rack-mounting screws.
2. Attach the other bracket in a similar fashion.

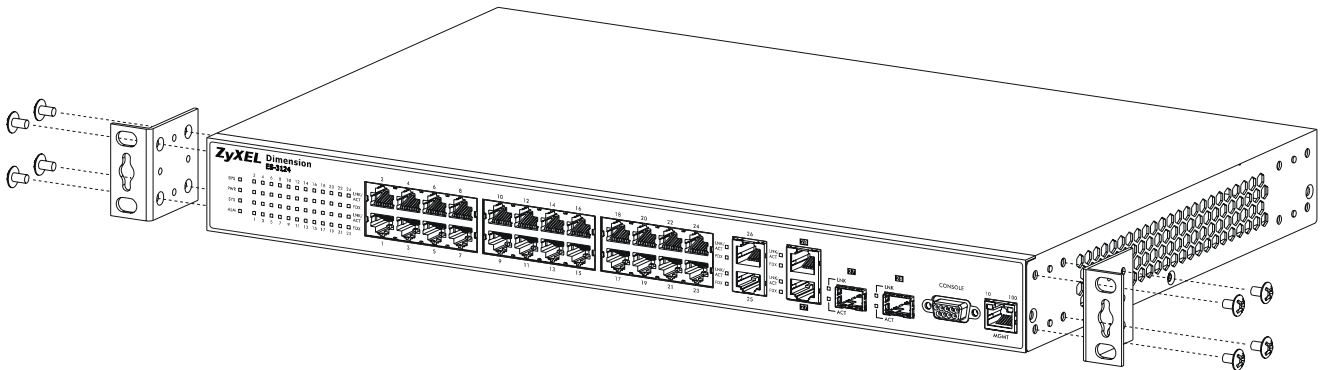

Figure 2-2 Attaching Mounting Brackets and Screws

3. After attaching both mounting brackets, position the switch in the rack by lining up the holes in the brackets with the appropriate holes on the rack. Secure the switch to the rack with the rack-mounting screws.

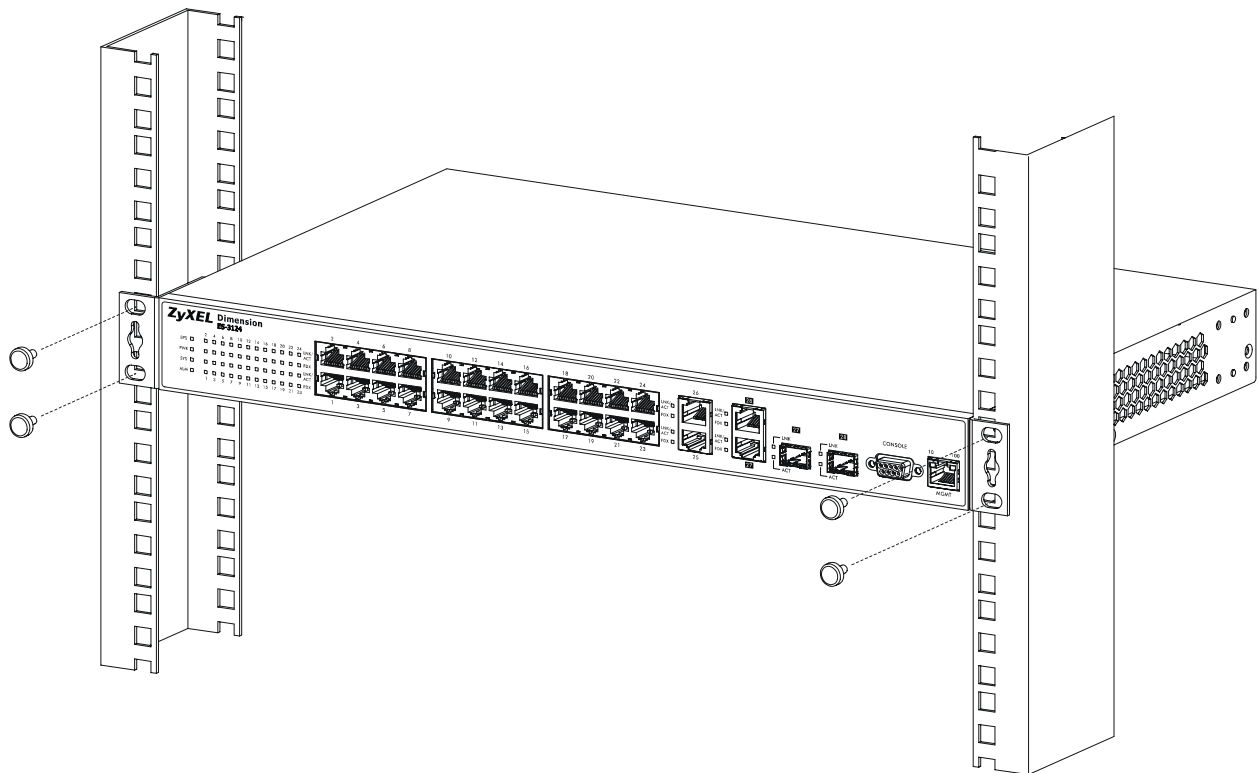

Figure 2-3 Mounting the ES to an EIA standard 19-inch rack

Chapter 3

Hardware Connections

This chapter acquaints you with the front and rear panels, shows you how to make the connections, install/remove (optional) modules and explains the LEDs.

3.1 Safety Warnings

- The length of exposed (bare) power wire should not exceed 7mm.
- Do not use this product near water, for example, in a wet basement.
- Only a qualified technician should service or disassemble this device.

3.2 Front Panel

The following figure shows the front panel of the ES-3124. The front panel contains switch LEDs, 24 RJ-45 Ethernet ports, four RJ-45 Gigabit ports, 2 mini GBIC ports, and a console port and a management port for local switch management.

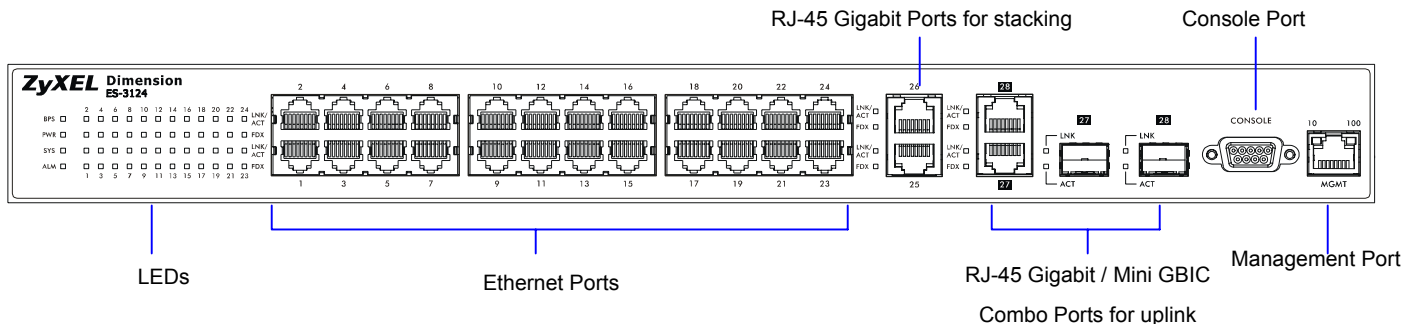

Figure 3-1 ES-3124 Front Panel

The following table describes the ports on the front panel.

Table 3-1 ES-3124: Front Panel Ports

CONNECTOR	DESCRIPTION
24 10/100 Mbps RJ-45 Ethernet connectors	Connect these ports to a computer, a hub, an Ethernet switch or router.
Four 100/1000 Mbps RJ-45 Gigabit Ports	Connect these 1Gbps Ethernet ports to high-bandwidth backbone network Ethernet switches or use them to daisy-chain other switches.
Two Mini GBIC Ports	Use mini GBIC transceivers in these slots for fiber-optical connections to backbone Ethernet switches.
Console Port	The console port is for local configuration of the switch.
Management Port	Connect to a computer using an RJ-45 Ethernet cable for local configuration of the switch.

3.2.1 Console Port

For local management, you can use a computer with terminal emulation software configured to the following parameters:

- VT100 terminal emulation
- 9600 bps
- No parity, 8 data bits, 1 stop bit
- No flow control

Connect the male 9-pin end of the console cable to the console port of the ES-3124 switch. Connect the female end to a serial port (COM1, COM2 or other COM port) of your computer.

3.2.2 Ethernet Ports

The ES-3124 has 10/100Mbps auto-negotiating, auto-crossover Ethernet ports. In 10/100Mbps Fast Ethernet, the speed can be 10Mbps or 100Mbps and the duplex mode can be half duplex or full duplex (100 Mbps only).

When auto-negotiation is turned on, an Ethernet port on the ES-3124 switch negotiates with the peer automatically to determine the connection speed and duplex mode. If the peer Ethernet port does not support auto-negotiation or turns off this feature, the ES-3124 switch determines the connection speed by detecting the signal on the cable and using half duplex mode. When the ES-3124 switch's auto-negotiation is turned off, an Ethernet port uses the pre-configured speed and duplex mode when making a connection, thus requiring you to make sure that the settings of the peer Ethernet port are the same in order to connect.

3.2.3 Gigabit Ports

The ES-3124 has four 100/1000Mbps auto-negotiating, auto-crossover Gigabit ports. The speed of the Gigabit ports can be 100Mbps or 1000Mbps and the duplex mode can be half duplex (at 100 Mbps) or full duplex.

When auto-negotiation is turned on, a Gigabit port on the ES-3124 negotiates with the peer automatically to determine the connection speed and duplex mode. If the peer Ethernet port does not support auto-negotiation or turns off this feature, the ES-3124 determines the connection speed by detecting the signal on the cable and using half duplex mode. When the ES-3124's auto-negotiation is turned off, a Gigabit port uses the pre-configured speed and duplex mode when making a connection, thus requiring you to make sure that the settings of the peer Ethernet port are the same in order to connect.

Two Gigabit ports for uplink are paired with the two mini GBIC slots. The switch uses up to one connection for each pair for a total of four possible Gigabit connections (one from each of the two pairs). The mini GBIC ports have priority over the Gigabit ports. This means that if a mini GBIC port and the corresponding Gigabit port are connected at the same time, the Gigabit port will be disabled.

Default Ethernet Negotiation Settings

The factory default negotiation settings for the Ethernet ports on the ES-3124 switch are:

- Speed: Auto
- Duplex: Auto
- Flow control: On
- Link Aggregation: Disabled

Auto-crossover

All ports are auto-crossover, that is auto-MDIX ports (Media Dependent Interface Crossover), so you may use either a straight through Ethernet cable or crossover Ethernet cable for all Ethernet port connections. Auto-crossover ports automatically sense whether they need to function as crossover or straight ports, so crossover cables can connect both computers and switches/hubs.

3.2.4 Mini GBIC Slots

These are slots for mini GBIC (Gigabit Interface Converter) transceivers. A transceiver is a single unit that houses a transmitter and a receiver. The ES-3124 does not come with transceivers. You must use transceivers that comply with the Small Form-factor Pluggable (SFP) Transceiver MultiSource Agreement (MSA). See the SFF committee's INF-8074i specification Rev 1.0 for details.

You can change transceivers while the switch is operating. You can use different transceivers to connect to Ethernet switches with different types of fiber-optic connectors.

To avoid possible eye injury, do not look into an operating fiber-optic module's connectors.

- Type: SFP connection interface
- Connection speed: 1 Gigabit per second (Gbps)

Transceiver Installation

Use the following steps to install a mini GBIC transceiver (SFP module).

1. Insert the transceiver into the slot with the exposed section of PCB board facing down.
2. Press the transceiver firmly until it clicks into place.
3. The switch automatically detects the installed transceiver. Check the LEDs to verify that it is functioning properly.



Figure 3-2 Transceiver Installation Example



Figure 3-3 Installed Transceiver

Transceiver Removal

Use the following steps to remove a mini GBIC transceiver (SFP module).

1. Open the transceiver's latch (latch styles vary).
2. Pull the transceiver out of the slot.

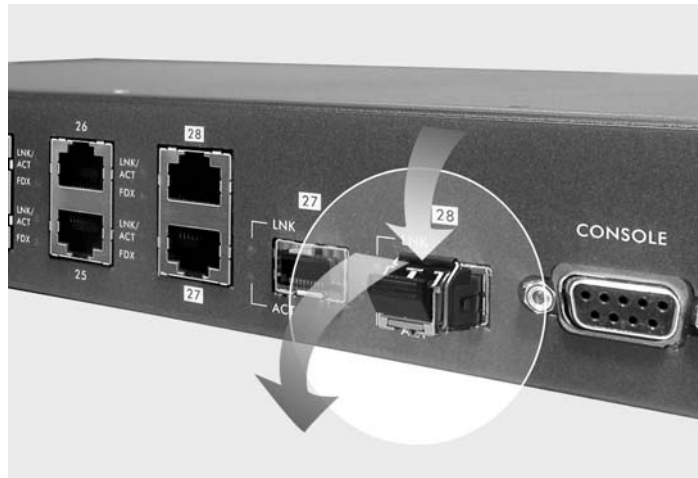

Figure 3-4 Opening the Transceiver's Latch Example



Figure 3-5 Transceiver Removal Example

3.2.5 Management Port

The **MGNT** (management) port is used for local management. Connect directly to this port using a STP (Shield Twisted-Pair) cable. You can configure the switch via Telnet or the web configurator.

The default IP address of the management port is 192.168.0.1 with a subnet mask of 255.255.255.0

3.3 Rear Panel

The following figure shows the rear panel of the ES-3124. The rear panel contains the ventilation holes, a connector for external backup power supply (BPS) and the power receptacle.

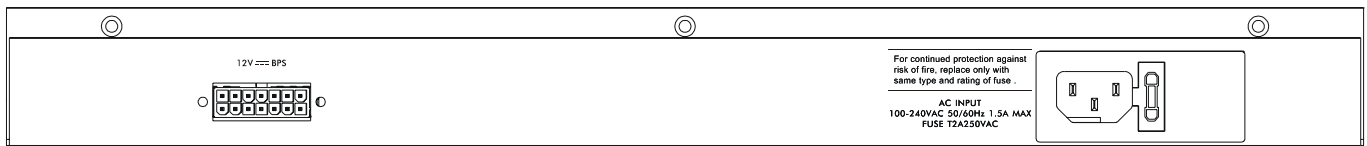

Figure 3-6 ES-3124 Rear Panel

3.3.1 Power Connector

Make sure you are using the correct power source as shown on the panel.

To connect the power to the ES-3124, insert the female end of power cord to the power receptacle on the rear panel. Connect the other end of the supplied power cord to a 100~240VAC/1.5A power outlet. Make sure that no objects obstruct the airflow of the fans (located on the side of the unit).

3.3.2 External Backup Power Supply Connector

The switch supports external backup power supply (BPS).

The backup power supply constantly monitors the status of the internal power supply. The backup power supply automatically provides power to the switch in the event of a power failure. Once the switch receives power from the backup power supply, it will not automatically switch back to using the internal power supply even when the power is resumed.

3.4 Front Panel LEDs

After you connect the power to the switch, view the LEDs to ensure proper functioning of the switch and as an aid in troubleshooting. The front panel LEDs are as follows.

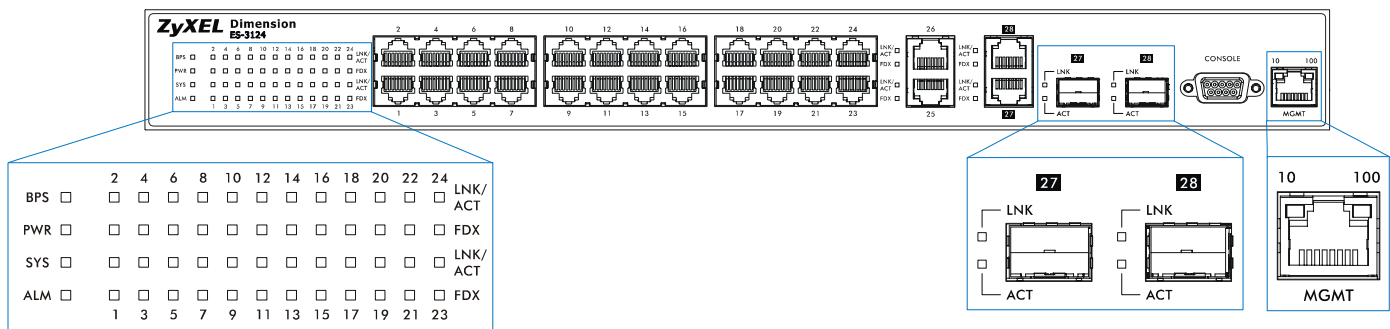

Figure 3-7 Front Panel LEDs

The following table describes the LED indicators on the front panel of an ES-3124 switch.

Table 3-2 ES-3124: LED Descriptions

LED	COLOR	STATUS	DESCRIPTION
BPS	Green	Blinking	The system is receiving power from the backup power supply.
		ON	The backup power supply is connected and active.
		OFF	The backup power supply is not ready or not active.
	Amber	Blinking	The system cannot get power from the backup power supply.

Table 3-2 ES-3124: LED Descriptions

LED	COLOR	STATUS	DESCRIPTION
PWR	Green	ON	The system is turned on.
		OFF	The system is off.
SYS	Green	Blinking	The system is rebooting and performing self-diagnostic tests.
		ON	The system is on and functioning properly.
		OFF	The power is off or the system is not ready/malfunctioning.
ALM	Red	ON	There is a hardware failure.
		OFF	The system is functioning normally.
LNK/ACT	Green	Blinking	The system is transmitting/receiving to/from a 10 Mbps Ethernet network.
		ON	The link to a 10 Mbps Ethernet network is up.
	Amber	Blinking	The system is transmitting/receiving to/from a 100 Mbps Ethernet network.
		ON	The link to a 100 Mbps Ethernet network is up.
		OFF	The link to a 100/10 Mbps Ethernet network is down.
FDX	Amber	ON	The Ethernet port is negotiating in full-duplex mode.
		OFF	The Ethernet port is negotiating in half-duplex mode and no collisions are occurring.
Gigabit Port			
LNK/ACT	Green	Blinking	The system is transmitting/receiving to/from a 1000 Mbps Ethernet network.
		ON	The link to a 1000 Mbps Ethernet network is up.
	Amber	Blinking	The system is transmitting/receiving to/from a 100 Mbps Ethernet network.
		ON	The link to a 100 Mbps Ethernet network is up.
		OFF	The link to an Ethernet network is down.
FDX	Amber	ON	The Gigabit port is negotiating in full-duplex mode.
		OFF	The Gigabit port is negotiating in half-duplex mode and no collisions are occurring.
GBIC Slot			
LINK	Green	ON	The link to this port is up.
		OFF	The link to this port is not connected.
ACT	Green	Blinking	This port is receiving or transmitting data
MGMT			
10	Green	Blinking	The system is transmitting/receiving to/from an Ethernet device.
		ON	The port is connected at 10 Mbps.
		OFF	The port is not connected at 10 Mbps or to an Ethernet device.
100	Amber	Blinking	The system is transmitting/receiving to/from an Ethernet device.
		ON	The port is connected at 100 Mbps.
		OFF	The port is not connected at 100 Mbps or to an Ethernet device.

3.5 Stacking Scenario Examples

Use Ethernet cables when stacking the switches. See the following figures for example stacking scenarios using the stacking ports. The switches must form a closed ring in all scenarios.

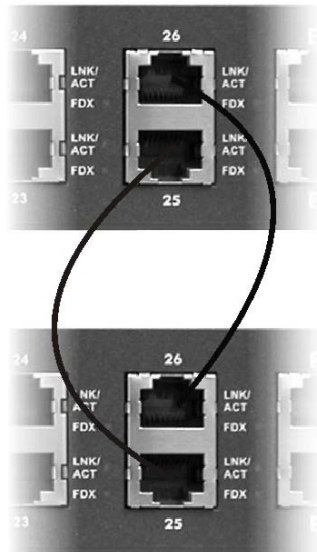

Figure 3-8 Stacking Example 1

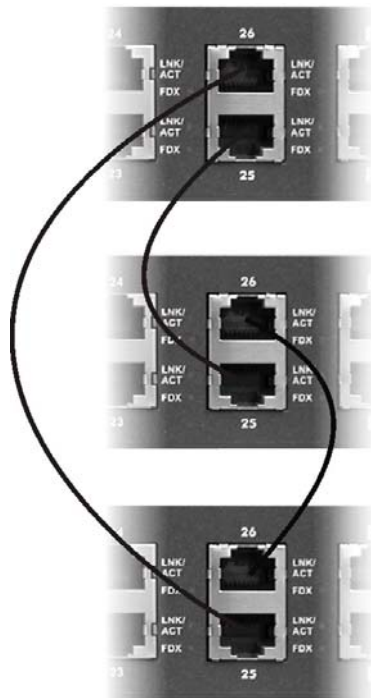

Figure 3-9 Stacking Example 2

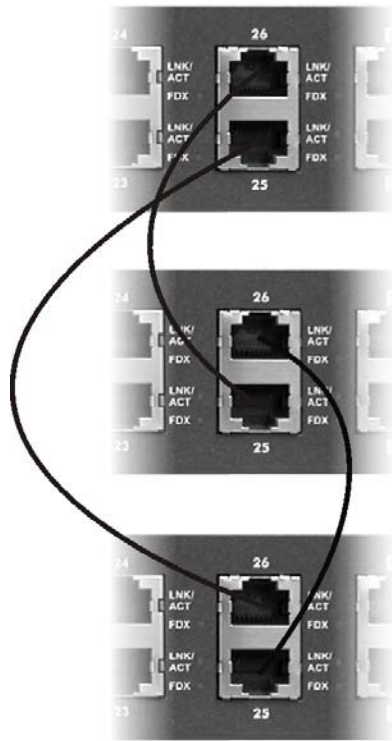

Figure 3-10 Stacking Example 3

See the *Commands Introduction* and *Commonly Used Commands* chapters for information on configuring the stacking ports (as well as other ports) using line commands.

3.6 Uplink Scenario Example

Use Ethernet cables when daisy-chaining/uplinking the switches. See the following figure for an example uplink connection using the stacking module. You must uplink to a Gigabit switch when uplinking using the stacking ports. Uplink scenarios using an uplink module depend on the uplink module you use.

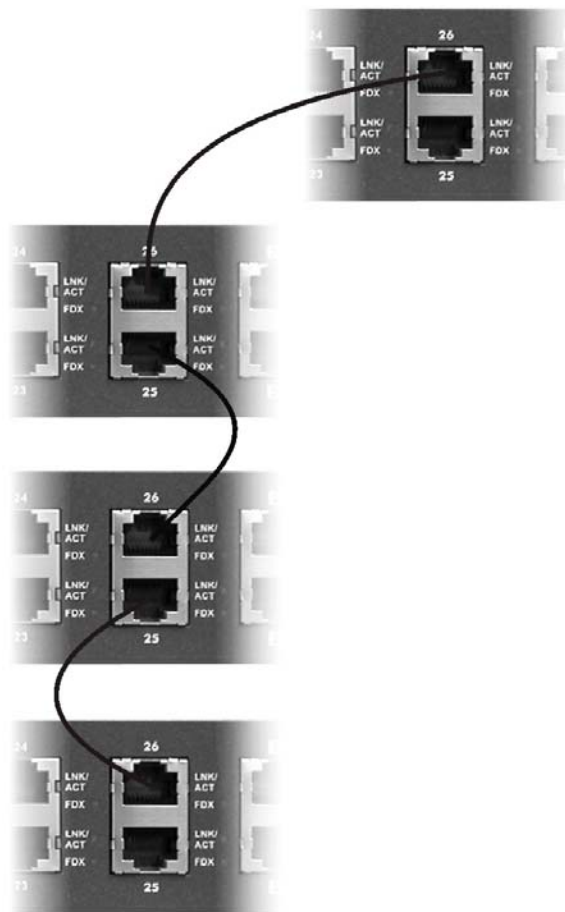

Figure 3-11 Uplink Example

3.7 Configuring the ES-3124

You may use the embedded web configurator or command line interface to configure the ES-3124. If you're using the web configurator, you need Internet Explorer 5.5 and later or Netscape Navigator 6 and later.

You can access the command line interface using a terminal emulation program on a computer connected to the switch console port (see *section 3.2.1*) or access the switch via an Ethernet port using Telnet.

You can use the “config save” command to save 802.1Q, STP, Cluster and IP configuration changes to non-volatile memory (Flash). These changes are effective after you restart the switch.

However you cannot use “config save” for all other line command configurations. These are saved in volatile memory (DRAM), so are not effective after you restart the switch.

The next part of this guide discusses configuring the ES-3124 using the web configurator.

Part III

Getting Started

This part introduces you to the ES-3124 web configurator, describes the Home and **System Info** screens and shows you how to configure the **Basic Settings** menus.

Chapter 4 Introducing the Web Configurator

This section introduces the configuration and functions of the web configurator.

4.1 Introduction

The embedded web configurator allows you to manage the switch from anywhere through a standard browser such as Microsoft Internet Explorer or Netscape Navigator.

Use Internet Explorer 5.5 and later or Netscape Navigator 6 and later versions.

4.2 System Login

A local console port connection locks out all other connections. Log out from the console port before logging in with the web configurator.

- Step 1.** Start your Internet Explorer or Netscape Navigator web browser.
- Step 2.** Type “http://” and the IP address of the switch (for example, the default for the management port is 192.168.0.1 and for the switch port is 192.168.1.1) in the Location or Address field. Press **Enter**.
- Step 3.** The login screen appears. The default username is **admin** and associated default password is **1234**. The date and time display as shown if you have not configured a time server nor manually entered a time and date in the **General Setup** screen.



Figure 4-1 Web Configurator: login

- Step 4.** Click **OK** to view the first web configurator screen.

4.3 Status Screen

The Status screen is the first web configurator screen you see after you log in. The following figure shows the navigating components of a web configurator screen.

The screenshot shows the ZyXEL web configurator interface. At the top left is the ZyXEL logo. Below it is a 'MENU' sidebar with options: Basic Setting, Advanced Application, Routing Protocol, and Management. The main content area is titled 'Status' and shows 'System Up Time: 0:41:37'. A table displays port statistics for ports 1 through 17. At the bottom, there are controls for 'Poll Interval(s)' (set to 40) and 'Port' (set to ALL), with buttons for 'Set Interval', 'Stop', and 'Clear Counter'. Callouts point to the 'Status', 'Logout', and 'Help' links in the top right, and the 'Navigation Panel' in the sidebar.

Port	Link	Mode	LACP	TxPkts	RxPkts	Errors	Tx KB/s	Rx KB/s	Uptime
1	Down	STOP	Disabled	0	0	0	0.0	0.0	0:00:00
2	Down	STOP	Disabled	0	0	0	0.0	0.0	0:00:00
3	Down	STOP	Disabled	0	0	0	0.0	0.0	0:00:00
4	Down	STOP	Disabled	0	0	0	0.0	0.0	0:00:00
5	Down	STOP	Disabled	0	0	0	0.0	0.0	0:00:00
6	Down	STOP	Disabled	0	0	0	0.0	0.0	0:00:00
7	Down	STOP	Disabled	0	0	0	0.0	0.0	0:00:00
8	Down	STOP	Disabled	0	0	0	0.0	0.0	0:00:00
9	Down	STOP	Disabled	0	0	0	0.0	0.0	0:00:00
10	Down	STOP	Disabled	0	0	0	0.0	0.0	0:00:00
11	Down	STOP	Disabled	0	0	0	0.0	0.0	0:00:00
12	Down	STOP	Disabled	0	0	0	0.0	0.0	0:00:00
13	Down	STOP	Disabled	0	0	0	0.0	0.0	0:00:00
14	Down	STOP	Disabled	0	0	0	0.0	0.0	0:00:00
15	Down	STOP	Disabled	0	0	0	0.0	0.0	0:00:00
16	Down	STOP	Disabled	0	0	0	0.0	0.0	0:00:00
17	100M/F	FORWARDING	Disabled	850	0	0	0.0	0.0	0:41:37

Figure 4-2 Web Configurator Home Screen (Status)

In the navigation panel, click a main link to reveal a list of submenu links.

Table 4-1 Navigation Panel Sub-links Overview

BASIC SETTING	ADVANCED APPLICATION	ROUTING PROTOCOL	MANAGEMENT

The following table lists the various web configurator screens within the sub-links.

Table 4-2 Web Configurator Screen Sub-links Details

BASIC SETTING	ADVANCED APPLICATIONS	ROUTING PROTOCOL	MANAGEMENT
System Info	VLAN Status	Static Routing	Maintenance
General Setup	VLAN Port Setting		Firmware Upgrade
Switch Setup	Static VLAN		Restore Configuration
IP Setup	Static MAC Forwarding		Backup Configuration
Port Setup	Filtering		Load Factory Default
	Spanning Tree Protocol		Reboot System
	Status		Diagnostic
	Configuration		Cluster Management
	Bandwidth Control		Status
	Broadcast Storm Control		Configuration
	Mirroring		MAC Table
	Link Aggregation LACP		ARP Table
	Status		
	Configuration		

Table 4-3 Navigation Panel Sub-link Descriptions

LABEL	DESCRIPTION
Broadcast Storm Control	This link takes you to a screen to set up broadcast filters.
Mirroring	This link takes you to screens where you can copy traffic from one port or ports to another port in order that you can examine the traffic from the mirrored port without interference
Link Aggregation	This link takes you to a screen where you can logically trunk physical links to form one logical, higher-bandwidth link.
Port Authentication	This link takes you to a screen where you can configure RADIUS (Remote Authentication Dial-In User Service), a protocol for user authentication that allows you to use an external server to validate an unlimited number of users.
Port Security	This link takes you to a screen where you can activate MAC address learning and set the maximum number of MAC addresses to learn on a port.
Access Control	This link takes you to screens where you can change the system login password and configure SNMP and remote management.
Queuing Method	This link takes you to a screen where you can configure strictly priority or weighted fair scheduling with associated queue weights for each port.
Classifier	This link takes you to a screen where you can configure classifiers.
Policy Rule	This link takes you to a screen where you can configure policy rules.
VLAN Stacking	This link takes you to a screen where you can configure VLAN stacking.
Routing Protocol	
Static Routing	This link takes you to screens where you can configure static routes. A static route defines how the ES-3124 should forward traffic by configuring the TCP/IP parameters manually.
Management	
Maintenance	This link takes you to screens where you can perform firmware and configuration file maintenance as well as reboot the system.
Diagnostic	This link takes you to screens where you can view system logs and test port(s).
Cluster Management	This link takes you to a screen where you can configure clustering management and view its status.
MAC Table	This link takes you to a screen where you can view the MAC addresses (and types) of devices attached to what ports and VLAN IDs.
ARP Table	This link takes you to a screen where you can view the MAC addresses – IP address resolution table.

4.3.1 Change Your Password

After you log in for the first time, it is recommended you change the default Administrator password in the **Logins** screen. Click **Advanced Application**, **Access Control** and then **Logins** to display the next screen.

Logins Access Control

Administrator

Old Password

New Password

Retype to confirm

Please record your new password whenever you change it. The system will lock you out if you have forgotten your password.

Edit Logins

Login	User Name	Password	Retype to confirm
1	<input type="text"/>	<input type="text"/>	<input type="text"/>
2	<input type="text"/>	<input type="text"/>	<input type="text"/>
3	<input type="text"/>	<input type="text"/>	<input type="text"/>
4	<input type="text"/>	<input type="text"/>	<input type="text"/>

Figure 4-3 Web Configurator: Change Password at Login

4.4 Switch Lockout

You are locked out from managing the switch if another administrator is currently logged in. You must wait until he/she has logged out before you can log in.

Moreover, you could lock yourself (and all others) out from the switch by:

1. Deleting the management VLAN (default is VLAN 1).
2. Deleting all port-based VLANs with the CPU port as a member. The “CPU port” is the management port of the switch.
3. Filtering all traffic to the CPU port.
4. Disabling all ports.
5. Assigning minimum bandwidth to the CPU port. If you limit bandwidth to the CPU port, you may find that the switch performs sluggishly or not at all.

Be careful not to lock yourself and others out of the switch.

4.5 Resetting the Switch

If you lock yourself (and others) from the switch or forget the ES-3124 password, you will need to reload the factory-default configuration file or reset the switch back to the factory defaults.

4.5.1 Reload the Configuration file

Uploading the factory-default configuration file replaces the current configuration file with the factory-default configuration file. This means that you will lose all previous configurations and the speed of the console port will be reset to the default of 9600bps with 8 data bit, no parity, one stop bit and flow control set to none. The password will also be reset to “1234” and the IP address to 192.168.1.1.

To upload the configuration file, do the following:

- Step 1.** Connect to the console port using a computer with terminal emulation software. See the chapter on hardware connections for details.
- Step 2.** Disconnect and reconnect the switch’s power to begin a session. When you reconnect the switch’s power, you will see the initial screen.
- Step 3.** When you see the message “Press any key to enter Debug Mode within 3 seconds” press any key to enter debug mode.
- Step 4.** Type `atlc` after the “Enter Debug Mode” message.
- Step 5.** Wait for the “Starting XMODEM upload” message before activating XMODEM upload on your terminal.
- Step 6.** Run the HyperTerminal program by clicking **Transfer**, then **Receive File** as shown in the following screen.

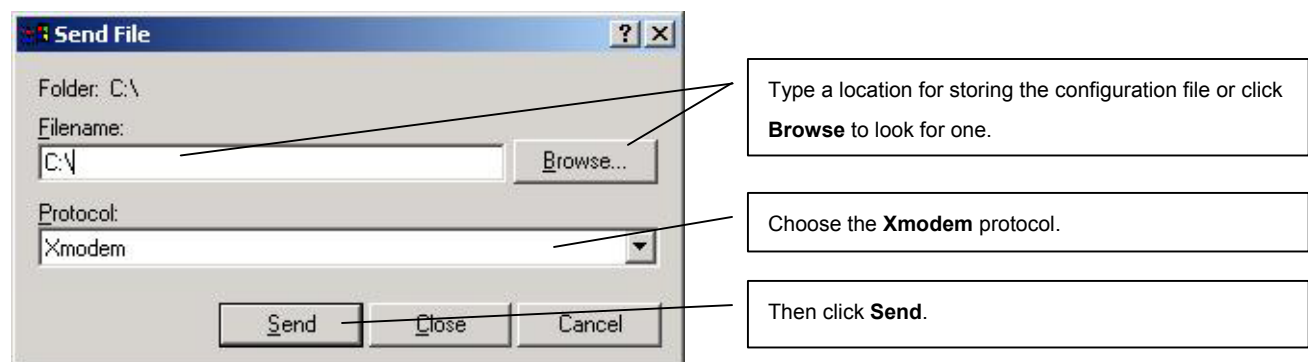

- Step 7.** After a successful configuration file upload, type `atgo` to restart the switch.

```
Bootbase Version: V0.6 | 10/01/2004 16:19:45
RAM:Size = 32 Mbytes
DRAM POST: Testing: 32768K OK
DRAM Test SUCCESS !
FLASH: Intel 32M

ZyNOS Version: V3.50(TP.0) | 10/01/2004 16:20:38

Press any key to enter debug mode within 3 seconds.
.....
Enter Debug Mode

ES-3124> atlc
Starting XMODEM upload (CRC mode)....
CCCCCCCCCCCCCCCCCCCCCCCCCCCCCCCCCCCC
Total 262144 bytes received.

Erasing..
.....
OK
ES-3124> atgo
```

Figure 4-4 Reload the Configuration file: Via Console Port

The switch is now reinitialized with a default configuration file including the default password of “1234”.

4.5.2 Reset to the Factory Defaults

To reset the switch back to the factory defaults, do the following:

- Step 1.** Connect to the console port using a computer with terminal emulation software. See the chapter on hardware connections for details.
- Step 2.** Disconnect and reconnect the switch’s power to begin a session. When you reconnect the switch’s power, you will see the initial screen.
- Step 3.** When you see the message “Press any key to enter Debug Mode within 3 seconds” press any key to enter debug mode.
- Step 4.** Type `atbr` after the “Enter Debug Mode” message.

```
Bootbase Version: V0.6 | 10/01/2004 16:19:45
RAM:Size = 32 Mbytes
DRAM POST: Testing: 32768K OK
DRAM Test SUCCESS !
FLASH: Intel 32M

ZyNOS Version: V3.50(TP.0) | 10/01/2004 16:20:38

Press any key to enter debug mode within 3 seconds.
.....
Enter Debug Mode

ES-3124> atbr
Restore default
Romfile.....OK
.....OK
ES-3124> atgo
```

Figure 4-5 Reset the Switch: Via Console Port

- Step 5.** After the resetting, type `atgo` to restart the switch.

4.5.3 Logging Out of the Web Configurator

Click **Logout** in a screen to exit the web configurator. You have to log in with your password again after you log out. This is recommended after you finish a management session both for security reasons and so as you don't lock out other switch administrators.



Figure 4-6 Web Configurator: Logout Screen

4.5.4 Help

The web configurator's online help has descriptions of individual screens and some supplementary information. Click the **HELP** link from a web configurator screen to view an online help description of that screen.

Chapter 5

System Status and Port Details

This chapter describes the system status (web configurator home page) and port details screens.

5.1 About System Statistics and Information

The home screen of the web configurator displays a port statistical summary with links to each port showing statistical details.

5.2 Port Status Summary

To view the port statistics, click **Status** in all web configurator screens to display the **Status** screen as shown next.

Status
System Up Time : 0:22:19

Port	Link	State	LACP	TxPkts	RxPkts	Errors	Tx KB/s	Rx KB/s	Up Time
1	Down	STOP	Disabled	0	0	0	0.0	0.0	0:00:00
2	100M/F	FORWARDING	Disabled	185	173	0	0.0	0.0	0:21:56
3	Down	STOP	Disabled	0	0	0	0.0	0.0	0:00:00
4	Down	STOP	Disabled	0	0	0	0.0	0.0	0:00:00
5	Down	STOP	Disabled	0	0	0	0.0	0.0	0:00:00
6	Down	STOP	Disabled	0	0	0	0.0	0.0	0:00:00
7	Down	STOP	Disabled	0	0	0	0.0	0.0	0:00:00
8	Down	STOP	Disabled	0	0	0	0.0	0.0	0:00:00
9	Down	STOP	Disabled	0	0	0	0.0	0.0	0:00:00
10	Down	STOP	Disabled	0	0	0	0.0	0.0	0:00:00
11	Down	STOP	Disabled	0	0	0	0.0	0.0	0:00:00
12	Down	STOP	Disabled	0	0	0	0.0	0.0	0:00:00
13	Down	STOP	Disabled	0	0	0	0.0	0.0	0:00:00
14	Down	STOP	Disabled	0	0	0	0.0	0.0	0:00:00
15	Down	STOP	Disabled	0	0	0	0.0	0.0	0:00:00
16	Down	STOP	Disabled	0	0	0	0.0	0.0	0:00:00
17	Down	STOP	Disabled	0	0	0	0.0	0.0	0:00:00
18	Down	STOP	Disabled	0	0	0	0.0	0.0	0:00:00
19	Down	STOP	Disabled	0	0	0	0.0	0.0	0:00:00

Poll Interval(s)
 Port

Figure 5-1 Port Status Summary

The following table describes the labels in this screen.

Table 5-1 Status

LABEL	DESCRIPTION
System up Time	This field shows how long the system has been running since the last time it was started.
Port	This identifies the Ethernet port. Click a port number to display the Port Details screen (refer to <i>Section 5.2.1</i>).
Link	This field displays the speed (either 10M for 10Mbps, 100M for 100Mbps or 1000M for 1000Mbps) and the duplex (F for full duplex or H for half).
State	This field displays the STP state of the port. See the <i>Spanning Tree Protocol</i> chapter for details on STP port states.
LACP	This fields displays whether the Link Aggregation Control Protocol (LACP) has been enabled on the port.
TxPkts	This field shows the number of transmitted frames on this port.
RxPkts	This field shows the number of received frames on this port.
Errors	This field shows the number of received errors on this port.
Tx KB/s	This field shows the number of kilobytes per second transmitted on this port.
Rx KB/s	This field shows the number of kilobytes per second received on this port.
Up Time	This field shows the total amount of time in hours, minutes and seconds the port has been up.
Poll Interval(s)	The text box displays how often (in seconds) this screen refreshes. You may change the refresh interval by typing a new number in the text box and then clicking Set Interval .
Stop	Click Stop to halt system statistic polling.
Clear Counter	Select a port from the Port drop-down list box and then click Clear Counter to erase the recorded statistical information for that port.

5.2.1 Port Details

Click a number in the **Port** column in the **Status** screen to display individual port statistics. Use this screen to check status and detailed performance data about an individual port on the switch.

Port Details [Status](#)

Port Info	Port NO.	1
	Link	Down
	Status	STOP
	LACP	Disabled
	TxPkts	0
	RxPkts	0
	Errors	0
	Tx KBs/s	0.0
	Rx KBs/s	0.0
	Up Time	0:00:00
TX Packet	TX Packets	0
	Multicast	0
	Broadcast	0
	Pause	0
RX Packet	RX Packets	0
	Multicast	0
	Broadcast	0
	Pause	0
	Control	0
TX Collision	Single	0
	Multiple	0
	Excessive	0
	Late	0
Error Packet	RX CRC	0
	Length	0
	Runt	0
Distribution	64	0
	65 to 127	0
	128 to 255	0
	256 to 511	0
	512 to 1023	0
	1024 to 1518	0
	Giant	0

Poll Interval(s)

Figure 5-2 Status: Port Details

The following table describes the labels in this screen.

Table 5-2 Status: Port Details

LABEL	DESCRIPTION
Port Info	

Table 5-2 Status: Port Details

LABEL	DESCRIPTION
Port NO.	This field identifies the Ethernet port described in this screen.
Link	This field shows whether the Ethernet connection is down, and the speed/duplex mode.
Status	This field shows the training state of the ports. The states are FORWARDING (forwarding), which means the link is functioning normally or STOP (the port is stopped to break a loop or duplicate path).
LACP	This field shows if LACP is enabled on this port or not.
TxPkts	This field shows the number of transmitted frames on this port
RxPkts	This field shows the number of received frames on this port
Errors	This field shows the number of received errors on this port.
Tx KBs/s	This field shows the number kilobytes per second transmitted on this port.
Rx KBs/s	This field shows the number of kilobytes per second received on this port.
Up Time	This field shows the total amount of time the connection has been up.
<p>Tx Packet</p> <p>The following fields display detailed information about frames transmitted.</p>	
TX Packets	This field shows the number of good frames (unicast, multicast and broadcast) transmitted.
Multicast	This field shows the number of good multicast frames transmitted.
Broadcast	This field shows the number of good broadcast frames transmitted.
Pause	This field shows the number of 802.3x Pause frames transmitted.
<p>Rx Packet</p> <p>The following fields display detailed information about frames received.</p>	
RX Packets	This field shows the number of good frames (unicast, multicast and broadcast) received.
Multicast	This field shows the number of good multicast frames received.
Broadcast	This field shows the number of good broadcast frames received.
Pause	This field shows the number of 802.3x Pause frames received.
Control	This field shows the number of control received (including those with CRC error) but it does not include the 802.3x Pause frames.
<p>TX Collision</p> <p>The following fields display information on collisions while transmitting.</p>	
Single	This is a count of successfully transmitted frames for which transmission is inhibited by exactly one collision.

Table 5-2 Status: Port Details

LABEL	DESCRIPTION
Multiple	This is a count of successfully transmitted frames for which transmission was inhibited by more than one collision.
Excessive	This is a count of frames for which transmission failed due to excessive collisions. Excessive collision is defined as the number of maximum collisions before the retransmission count is reset.
Late	This is the number of times a late collision is detected, that is, after 512 bits of the frame have already been transmitted.
Error Packet	The following fields display detailed information about frames received that were in error.
RX CRC	This field shows the number of frames received with CRC (Cyclic Redundant Check) error(s).
Length	This field shows the number of frames received with a length that was out of range.
Runt	This field shows the number of frames received that were too short (shorter than 64 octets), including the ones with CRC errors.
Distribution The following fields display the number of frames received.	
64	This field shows the number of frames (including bad frames) received that were 64 octets in length.
65 to 127	This field shows the number of frames (including bad frames) received that were between 65 and 127 octets in length.
128 to 255	This field shows the number of frames (including bad frames) received that were between 128 and 255 octets in length.
256 to 511	This field shows the number of frames (including bad frames) received that were between 256 and 511 octets in length.
512 to 1023	This field shows the number of frames (including bad frames) received that were between 512 and 1023 octets in length.
1024 to 1518	This field shows the number of frames (including bad frames) received that were between 1024 and 1518 octets in length.
Giant	This field shows the number of frames dropped because they were bigger than the maximum frame size.
Poll Interval(s)	The text box displays how often (in seconds) this screen refreshes. You may change the refresh interval by typing a new number in the text box and then clicking Set Interval .
Stop	Click Stop to stop port statistic polling.

Chapter 6

Basic Setting

*This chapter describes how to configure the **System Info**, **General Setup**, **Switch Setup**, **IP Setup** and **Port Setup** screens.*

6.1 Introducing The Basic Setting Screens

The **System Info** screen displays general switch information (such as firmware version number) and hardware polling information (such as fan speeds). The **General Setup** screen allows you to configure general switch identification information. The **General Setup** screen also allows you to set the system time manually or get the current time and date from an external server when you turn on your switch. The real time is then displayed in the switch logs. The **Switch Setup** screen allows you to set up and configure global switch features. The **IP Setup** screen allows you to configure a switch IP address, subnet mask and DNS (domain name server) for management purposes.

6.2 System Information

In the navigation panel, click **Basic Setting** and then **System Info** to display the screen as shown. You can check the firmware version number and monitor the switch temperature, fan speeds and voltage in this screen.

System Info

System Name	ES-3124
OS FW Version	ZyNOS FW Version: V3.50(TP.0) 10/01/2004
Ethernet Address	00:a0:c5:01:23:46

Hardware Monitor
 Temperature Unit

Temperature(C)	Current	MAX	MIN	Threshold	Status
MAC	39.0	39.0	39.0	85.0	Normal
CPU	36.0	36.0	36.0	85.0	Normal
PHY	34.5	34.5	34.0	85.0	Normal
FAN Speed (RPM)	Current	MAX	MIN	Threshold	Status
FAN1	5908	5958	5810	2750	Normal
FAN2	5958	5958	5908	2750	Normal
FAN3	5716	5859	5670	2750	Normal
Voltage (V)	Current	MAX	MIN	Threshold	Status
VCOREA	2.528	2.528	2.528	+/- 10%	Normal
VINRO	1.216	1.216	1.216	+/- 10%	Normal
3.3	3.328	3.328	3.328	+/- 8%	Normal
12	12.038	12.038	11.977	+/- 11%	Normal
1.3	1.328	1.328	1.312	+/- 10%	Normal
1.25	1.216	1.232	1.216	+/- 8%	Normal
1.8	1.824	1.824	1.824	+/- 10%	Normal
BPS_12VIN	--	--	--	--	Absent

Poll Interval(s)

Figure 6-1 System Info

The following table describes the labels in this screen.

Table 6-1 System Info

LABEL	DESCRIPTION
System Name	This field displays the switch 's model name.
OS F/W Version	This field displays the version number of the switch 's current firmware including the date created.
Ethernet Address	This field refers to the Ethernet MAC (Media Access Control) address of the switch.
Hardware Monitor	
Temperature Unit	The switch has temperature sensors that are capable of detecting and reporting if the temperature rises above the threshold. You may choose the temperature unit (Centigrade or Fahrenheit) in this field.

Table 6-1 System Info

LABEL	DESCRIPTION
Temperature	MAC , CPU and PHY refer to the location of the temperature sensors on the switch printed circuit board.
Current	This field displays the current temperature measured at this sensor.
MAX	This field displays the maximum temperature measured at this sensor.
MIN	This field displays the minimum temperature measured at this sensor.
Threshold	This field displays the upper temperature limit at this sensor.
Status	This field displays Normal for temperatures below the threshold and Error for those above.
Fan speed (RPM)	A properly functioning fan is an essential component (along with a sufficiently ventilated, cool operating environment) in order for the device to stay within the temperature threshold. Each fan has a sensor that is capable of detecting and reporting if the fan speed falls below the threshold shown.
Current	This field displays this fan's current speed in Revolutions Per Minute (RPM).
MAX	This field displays this fan's maximum speed measured in Revolutions Per Minute (RPM).
MIN	This field displays this fan's minimum speed measured in Revolutions Per Minute (RPM). "<41" is displayed for speeds too small to measure (under 2000 RPM).
Threshold	This field displays the minimum speed at which a normal fan should work.
Status	Normal indicates that this fan is functioning above the minimum speed. Error indicates that this fan is functioning below the minimum speed.
Voltage (V)	The power supply for each voltage has a sensor that is capable of detecting and reporting if the voltage falls out of the tolerance range.
Current	This is the current voltage reading.
MAX	This field displays the maximum voltage measured at this point.
MIN	This field displays the minimum voltage measured at this point.
Threshold	This field displays the minimum voltage percentage at which the switch should work.
Status	Normal indicates that the voltage is within an acceptable operating range at this point; otherwise Error is displayed.
Poll Interval(s)	The text box displays how often (in seconds) this screen refreshes. You may change the refresh interval by typing a new number in the text box and then clicking Set Interval .
Stop	Click Stop to halt statistic polling.

6.3 General Setup

Click **Basic Setting** and **General Setup** in the navigation panel to display the screen as shown.

General Setup

System Name: ES-3124

Location: [Empty]

Contact Person's Name: [Empty]

Login Precedence: Local Only

Use Time Server when Bootup: None

Time Server IP Address: 0.0.0.0

Current Time: 00 : 10 : 07

New Time (hh:mm:ss): 00 : 10 : 07

Current Date: 1970 - 01 - 01

New Date (yyyy-mm-dd): 1970 - 01 - 01

Time Zone: UTC

It will take 60 seconds if time server is unreachable.

Apply Cancel

Figure 6-2 General Setup

The following table describes the labels in this screen.

Table 6-2 General Setup

LABEL	DESCRIPTION
System Name	Choose a descriptive name for identification purposes. This name consists of up to 32 printable characters; spaces are not allowed.
Location	Enter the geographic location (up to 30 characters) of your switch.
Contact Person's Name	Enter the name (up to 30 characters) of the person in charge of this switch.

Table 6-2 General Setup

LABEL	DESCRIPTION
Login Precedence	<p>Configure the local user accounts in the Access Control Logins screen. The RADIUS is an external server. Use this drop-down list box to select which database the ES-3124 should use (first) to authenticate a user.</p> <p>Before you specify the priority, make sure you have set up the corresponding database correctly first.</p> <p>Select Local Only to have the ES-3124 just check the local user accounts configured in the Access Control Logins screen.</p> <p>Select Local then RADIUS to have the ES-3124 check the local user accounts configured in the Access Control Logins screen. If the user name is not found, the ES-3124 then checks the user database on the specified RADIUS server. You need to configure Port Authentication Radius first.</p> <p>Select RADIUS Only to have the ES-3124 just check the user database on the specified RADIUS server for a login username and password.</p>
Use Time Server When Bootup	<p>Enter the time service protocol that a timeserver sends when you turn on the switch. Not all timeservers support all protocols, so you may have to use trial and error to find a protocol that works. The main differences between them are the time format.</p> <p>Daytime (RFC 867) format is day/month/year/time zone of the server.</p> <p>Time (RFC-868) format displays a 4-byte integer giving the total number of seconds since 1970/1/1 at 0:0:0.</p> <p>NTP (RFC-1305) is similar to Time (RFC-868).</p> <p>None is the default value. Enter the time manually. Each time you turn on the switch, the time and date will be reset to 1970-1-1 0:0.</p>
Time Server IP Address	<p>Enter the IP address (or URL if you configure a domain name server in the IP Setup screen) of your timeserver. The switch searches for the timeserver for up to 60 seconds. If you select a timeserver that is unreachable, then this screen will appear locked for 60 seconds. Please wait.</p>
Current Time	<p>This field displays the time you open this menu (or refresh the menu).</p>
New Time (hh:min:ss)	<p>Enter the new time in hour, minute and second format. The new time then appears in the Current Time field after you click Apply.</p>
Current Date	<p>This field displays the date you open this menu.</p>
New Date (yyyy-mm-dd)	<p>Enter the new date in year, month and day format. The new date then appears in the Current Date field after you click Apply.</p>
Time Zone	<p>Select the time difference between UTC (Universal Time Coordinated, formerly known as GMT, Greenwich Mean Time) and your time zone from the drop-down list box.</p>
Apply	<p>Click Apply to save the settings.</p>
Cancel	<p>Click Cancel to start configuring the screen again.</p>

6.4 Introduction to VLANs

A VLAN (Virtual Local Area Network) allows a physical network to be partitioned into multiple logical networks. Devices on a logical network belong to one group. A device can belong to more than one group. With VLAN, a device cannot directly talk to or hear from devices that are not in the same group(s); the traffic must first go through a router.

In MTU (Multi-Tenant Unit) applications, VLAN is vital in providing isolation and security among the subscribers. When properly configured, VLAN prevents one subscriber from accessing the network resources of another on the same LAN, thus a user will not see the printers and hard disks of another user in the same building.

VLAN also increases network performance by limiting broadcasts to a smaller and more manageable logical broadcast domain. In traditional switched environments, all broadcast packets go to each and every individual port. With VLAN, all broadcasts are confined to a specific broadcast domain.

Note that VLAN is unidirectional; it only governs outgoing traffic.

See the *VLAN* chapter for information on port-based and 802.1Q tagged VLANs.

6.5 IGMP Snooping

IGMP (Internet Group Multicast Protocol) is a session-layer protocol used to establish membership in a multicast group - it is not used to carry user data. Refer to *RFC 1112* and *RFC 2236* for information on IGMP versions 1 and 2 respectively.

A layer-2 switch can passively snoop on IGMP Query, Report and Leave (IGMP version 2) packets transferred between IP multicast routers/switches and IP multicast hosts to learn the IP multicast group membership. It checks IGMP packets passing through it, picks out the group registration information, and configures multicasting accordingly.

Without IGMP snooping, multicast traffic is treated in the same manner as broadcast traffic, that is, it is forwarded to all ports. With IGMP snooping, group multicast traffic is only forwarded to ports that are members of that group. IGMP Snooping generates no additional network traffic, allowing you to significantly reduce multicast traffic passing through your switch.

6.6 Switch Setup Screen

Click **Basic Setting** and then **Switch Setup** in the navigation panel display the screen as shown. The VLAN setup screens change depending on whether you choose **802.1Q** or **Port Based** in the **VLAN Type** field in this screen. Refer to the chapter on VLANs.

Switch Setup

VLAN Type: 802.1Q Port Based

IGMP Snooping: Active

MAC Address Learning: Aging Time: 300 seconds

Join Timer: 200 milliseconds

GARP Timer: Leave Timer: 600 milliseconds

Leave All Timer: 10000 milliseconds

Priority Queue Assignment:

- level7: 7
- level6: 6
- level5: 5
- level4: 4
- level3: 3
- level2: 1
- level1: 0
- level0: 2

Apply Cancel

Figure 6-3 Switch Setup

The following table describes the labels in this screen.

Table 6-3 Switch Setup

LABEL	DESCRIPTION	EXAMPLE
VLAN Type	Choose 802.1Q or Port Based from the drop-down list box. The VLAN Setup screen changes depending on whether you choose 802.1Q VLAN Type or Port Based VLAN Type in this screen. See <i>Section 6.4</i> and the <i>VLAN</i> chapter for more information on VLANs.	802.1Q
IGMP Snooping	Select Active to enable IGMP snooping have group multicast traffic only forwarded to ports that are members of the VLAN specified in the VLAN field, significantly reducing multicast traffic passing through your switch. See <i>Section 6.5</i> for more information on IGMP snooping.	
MAC Address Learning	MAC address learning reduces outgoing traffic broadcasts. For MAC address learning to occur on a port, the port must be active.	
Aging Time	Enter a time from 10 to 3000 seconds. This is how long all dynamically learned MAC addresses remain in the MAC address table before they age out (and must be relearned).	300

Table 6-3 Switch Setup

LABEL	DESCRIPTION	EXAMPLE
<p>GARP Timer: Switches join VLANs by making a declaration. A declaration is made by issuing a Join message using GARP. Declarations are withdrawn by issuing a Leave message. A Leave All message terminates all registrations. GARP timers set declaration timeout values. See the chapter on VLAN setup for more background information.</p>		
Join Timer	Join Timer sets the duration of the Join Period timer for GVRP in milliseconds. Each port has a Join Period timer. The allowed Join Time range is between 100 and 65535 milliseconds; the default is 200 milliseconds. See the chapter on VLAN setup for more background information.	200 milliseconds (default)
Leave Timer	Leave Timer sets the duration of the Leave Period timer for GVRP in milliseconds. Each port has a single Leave Period timer. Leave Time must be two times larger than Join Timer; the default is 600 milliseconds.	600 milliseconds (default)
Leave All Timer	Leave All Timer sets the duration of the Leave All Period timer for GVRP in milliseconds. Each port has a single Leave All Period timer. Leave All Timer must be larger than Leave Timer; the default is 1000 milliseconds.	1000 milliseconds (default)
<p>Priority Queue Assignment</p> <p>IEEE 802.1p defines up to 8 separate traffic types by inserting a tag into a MAC-layer frame that contains bits to define class of service. Frames without an explicit priority tag are given the default priority of the ingress port. Use these fields to configure the priority level-to-physical queue mapping.</p> <p>The switch has 8 physical queues that you can map to the 8 priority levels. On the switch, traffic assigned to higher index queues gets through faster while traffic in lower index queues is dropped if the network is congested.</p> <p>See also Queuing Method and 802.1p Priority in Port Setup for related information.</p>		
<p>Priority Level (The following descriptions are based on the traffic types defined in the IEEE 802.1d standard (which incorporates the 802.1p).</p>		
Level 7	Typically used for network control traffic such as router configuration messages.	
Level 6	Typically used for voice traffic that is especially sensitive to jitter (jitter is the variations in delay).	
Level 5	Typically used for video that consumes high bandwidth and is sensitive to jitter.	
Level 4	Typically used for controlled load, latency-sensitive traffic such as SNA (Systems Network Architecture) transactions.	
Level 3	Typically used for “excellent effort” or better than best effort and would include important business traffic that can tolerate some delay.	
Level 2	This is for “spare bandwidth”.	
Level 1	This is typically used for non-critical “background” traffic such as bulk transfers that are allowed but that should not affect other applications and users.	
Level 0	Typically used for best-effort traffic.	
Apply	Click Apply to save your changes back to the switch.	
Cancel	Click Cancel to begin configuring this screen afresh.	

6.7 IP Setup

Use the **IP Setup** screen to configure the default gateway device, the default domain name server and add IP domains.

Figure 6-4 IP Setup

To set the default gateway device and the domain name server on the switch, click **IP Setup** in the navigation panel and set the related fields. The default gateway specifies the IP address of the default gateway (next hop) for outgoing traffic.

The following table describes the labels in this screen.

Table 6-4 IP Setup

LABEL	DESCRIPTION
Domain Name Server	DNS (Domain Name System) is for mapping a domain name to its corresponding IP address and vice versa. Enter a domain name server IP address in order to be able to use a domain name instead of an IP address.
In-band Management IP Address	
DHCP Client	Select this option if you have a DHCP server that can assign the switch an IP address, subnet mask, a default gateway IP address and a domain name server IP address automatically.
Static IP Address	Select this option if you don't have a DHCP server or if you wish to assign static IP address information to the switch. You need to fill in the following fields when you select this option.

Table 6-4 IP Setup

LABEL	DESCRIPTION
IP Address	Enter the IP address of your switch in dotted decimal notation for example 192.168.1.1.
IP Subnet Mask	Enter the IP subnet mask of your switch in dotted decimal notation for example 255.255.255.0.
Default Gateway	Enter the IP address of the default outgoing gateway in dotted decimal notation, for example 192.168.1.254.
Management VID	Enter the VLAN identification number associated with the switch IP address. Management VLAN ID is the VLAN ID of the CPU and is used for management only. The default is "1". All ports, by default, are fixed members of this "management VLAN" in order to manage the device from any port. If a port is not a member of this VLAN, then users on that port cannot access the device. To access the switch make sure the port that you are connected to is a member of Management VLAN.
Out-of-band Management IP Address	
IP Address	Enter the IP address of your switch in dotted decimal notation for example 192.168.0.1. If you change this IP address, make sure the computer connected to this management port is in the same subnet before accessing the ES-3124.
IP Subnet Mask	Enter the IP subnet mask of your switch in dotted decimal notation for example 255.255.255.0.
Default Gateway	Enter the IP address of the default outgoing gateway in dotted decimal notation, for example 192.168.0.254.
Apply	Click Apply to save your changes back to the switch.
Cancel	Click Cancel to begin configuring the fields again.

6.8 Port Setup

Click **Basic Setting** and then **Port Setup** in the navigation panel to enter the port configuration screen. You may configure any of the switch ports.

Port Setup							
Port	Active	Name	Type	Speed / Duplex	Flow Control	802.1p Priority	
1	<input checked="" type="checkbox"/>	port01	10/100M	Auto	<input type="checkbox"/>	0	
2	<input checked="" type="checkbox"/>	port02	10/100M	Auto	<input type="checkbox"/>	0	
3	<input checked="" type="checkbox"/>	port03	10/100M	Auto	<input type="checkbox"/>	0	
4	<input checked="" type="checkbox"/>	port04	10/100M	Auto	<input type="checkbox"/>	0	
5	<input checked="" type="checkbox"/>	port05	10/100M	Auto	<input type="checkbox"/>	0	
6	<input checked="" type="checkbox"/>	port06	10/100M	Auto	<input type="checkbox"/>	0	
7	<input checked="" type="checkbox"/>	port07	10/100M	Auto	<input type="checkbox"/>	0	
8	<input checked="" type="checkbox"/>	port08	10/100M	Auto	<input type="checkbox"/>	0	
9	<input checked="" type="checkbox"/>	port09	10/100M	Auto	<input type="checkbox"/>	0	
10	<input checked="" type="checkbox"/>	port10	10/100M	Auto	<input type="checkbox"/>	0	
11	<input checked="" type="checkbox"/>	port11	10/100M	Auto	<input type="checkbox"/>	0	
12	<input checked="" type="checkbox"/>	port12	10/100M	Auto	<input type="checkbox"/>	0	
13	<input checked="" type="checkbox"/>	port13	10/100M	Auto	<input type="checkbox"/>	0	
14	<input checked="" type="checkbox"/>	port14	10/100M	Auto	<input type="checkbox"/>	0	
15	<input checked="" type="checkbox"/>	port15	10/100M	Auto	<input type="checkbox"/>	0	
16	<input checked="" type="checkbox"/>	port16	10/100M	Auto	<input type="checkbox"/>	0	
17	<input checked="" type="checkbox"/>	port17	10/100M	Auto	<input type="checkbox"/>	0	
18	<input checked="" type="checkbox"/>	port18	10/100M	Auto	<input type="checkbox"/>	0	
19	<input checked="" type="checkbox"/>	port19	10/100M	Auto	<input type="checkbox"/>	0	
20	<input checked="" type="checkbox"/>	port20	10/100M	Auto	<input type="checkbox"/>	0	
21	<input checked="" type="checkbox"/>	port21	10/100M	Auto	<input type="checkbox"/>	0	
22	<input checked="" type="checkbox"/>	port22	10/100M	Auto	<input type="checkbox"/>	0	
23	<input checked="" type="checkbox"/>	port23	10/100M	Auto	<input type="checkbox"/>	0	
24	<input checked="" type="checkbox"/>	port24	10/100M	Auto	<input type="checkbox"/>	0	
25	<input checked="" type="checkbox"/>	port25	100/1000M	Auto	<input type="checkbox"/>	0	
26	<input checked="" type="checkbox"/>	port26	100/1000M	Auto	<input type="checkbox"/>	0	
27	<input checked="" type="checkbox"/>	Port27	100/1000M	Auto	<input type="checkbox"/>	0	
28	<input checked="" type="checkbox"/>	Port28	100/1000M	Auto	<input type="checkbox"/>	0	

Figure 6-5 Port Setup

The following table describes the fields in this screen.

Table 6-5 Port Setup

LABEL	DESCRIPTION
Port	This is the port index number.
Active	Select this check box to enable a port. The factory default for all ports is enabled. A port must be enabled for data transmission to occur.
Name	Enter a descriptive name that identifies this port.
Type	This field displays 10/100M for an Ethernet/Fast Ethernet connection and 100/1000M for Gigabit connections.
Speed/Duplex	<p>Select the speed and the duplex mode of the Ethernet connection on this port. Choices are Auto, 10M/Half Duplex, 10M/Full Duplex, 100M/Half Duplex, 100M/Full Duplex and 1000M/Full Duplex (for Gigabit ports only).</p> <p>Selecting Auto (auto-negotiation) makes one Ethernet port able to negotiate with a peer automatically to obtain the connection speed and duplex mode that both ends support. When auto-negotiation is turned on, an Ethernet port on the switch negotiates with the peer automatically to determine the connection speed and duplex mode. If the peer Ethernet port does not support auto-negotiation or turns off this feature, the switch determines the connection speed by detecting the signal on the cable and using half duplex mode. When the switch's auto-negotiation is turned off, an Ethernet port uses the pre-configured speed and duplex mode when making a connection, thus requiring you to make sure that the settings of the peer Ethernet port are the same in order to connect.</p>
Flow Control	<p>A concentration of traffic on a port decreases port bandwidth and overflows buffer memory causing packet discards and frame losses. Flow Control is used to regulate transmission of signals to match the bandwidth of the receiving port.</p> <p>The switch uses IEEE802.3x flow control in full duplex mode and backpressure flow control in half duplex mode.</p> <p>IEEE802.3x flow control is used in full duplex mode to send a pause signal to the sending port, causing it to temporarily stop sending signals when the receiving port memory buffers fill.</p> <p>Back Pressure flow control is typically used in half duplex mode to send a "collision" signal to the sending port (mimicking a state of packet collision) causing the sending port to temporarily stop sending signals and resend later. Select Flow Control to enable it.</p>
802.1p Priority	This priority value is added to incoming frames without a (802.1p) priority queue tag. See Priority Queue Assignment in <i>Table 6-3</i> for more information. See also Priority Queue Assignment in Switch Setup and Queuing Method for related information.
Apply	Click Apply to save your changes back to the switch.
Cancel	Click Cancel to begin configuring this screen afresh.

Part IV

Advanced Application 1

This part shows you how to configure the VLAN, Static MAC Forwarding, Filtering, STP and Bandwidth Control Advanced Application screens.

Chapter 7

VLAN

*The type of screen you see here depends on the **VLAN Type** you selected in the **Switch Setup** screen. This chapter shows you how to configure 802.1Q tagged and port-based VLANs. See the *General, Switch and IP Setup* chapter for more information.*

7.1 Introduction to IEEE 802.1Q Tagged VLAN

Tagged VLAN uses an explicit tag (VLAN ID) in the MAC header to identify the VLAN membership of a frame across bridges - they are not confined to the switch on which they were created. The VLANs can be created statically by hand or dynamically through GVRP. The VLAN ID associates a frame with a specific VLAN and provides the information that switches need to process the frame across the network. A tagged frame is four bytes longer than an untagged frame and contains two bytes of TPID (Tag Protocol Identifier, residing within the type/length field of the Ethernet frame) and two bytes of TCI (Tag Control Information, starts after the source address field of the Ethernet frame).

The CFI (Canonical Format Indicator) is a single-bit flag, always set to zero for Ethernet switches. If a frame received at an Ethernet port has a CFI set to 1, then that frame should not be forwarded as it is to an untagged port. The remaining twelve bits define the VLAN ID, giving a possible maximum number of 4,096 (2¹²) VLANs. Note that user priority and VLAN ID are independent of each other. A frame with VID (VLAN Identifier) of null (0) is called a priority frame, meaning that only the priority level is significant and the default VID of the ingress port is given as the VID of the frame. Of the 4096 possible VIDs, a VID of 0 is used to identify priority frames and value 4095 (FFF) is reserved, so the maximum possible VLAN configurations are 4,094

TPID 2 Bytes	User Priority 3 Bits	CFI 1 Bit	VLAN ID 12 bits
-----------------	-------------------------	--------------	--------------------

7.1.1 Forwarding Tagged and Untagged Frames

Each port on the switch is capable of passing tagged or untagged frames. To forward a frame from an 802.1Q VLAN-aware switch to an 802.1Q VLAN-unaware switch, the switch first decides where to forward the frame and then strips off the VLAN tag. To forward a frame from an 802.1Q VLAN-unaware switch to an 802.1Q VLAN-aware switch, the switch first decides where to forward the frame, and then inserts a VLAN tag reflecting the ingress port's default VID. The default PVID is VLAN 1 for all ports, but this can be changed.

7.1.2 Automatic VLAN Registration

GARP and GVRP are the protocols used to automatically register VLAN membership across switches.

GARP

GARP (Generic Attribute Registration Protocol) allows network switches to register and de-register attribute values with other GARP participants within a bridged LAN. GARP is a protocol that provides a generic mechanism for protocols that serve a more specific application, for example, GVRP.

GARP Timers

Switches join VLANs by making a declaration. A declaration is made by issuing a Join message using GARP. Declarations are withdrawn by issuing a Leave message. A Leave All message terminates all registrations. GARP timers set declaration timeout values.

GVRP

GVRP (GARP VLAN Registration Protocol) is a registration protocol that defines a way for switches to register necessary VLAN members on ports across the network. Enable this function to permit VLANs groups beyond the local switch.

Please refer to the following table for common GARP terminology.

Table 7-1 GARP Terminology

VLAN PARAMETER	TERM	DESCRIPTION
VLAN Type	Permanent VLAN	This is a static VLAN created manually.
	Dynamic VLAN	This is a VLAN configured by a GVRP registration/deregistration process.
VLAN Administrative Control	Registration Fixed	Fixed registration ports are permanent VLAN members.
	Registration Forbidden	Ports with registration forbidden are forbidden to join the specified VLAN.
	Normal Registration	Ports dynamically join a VLAN using GVRP.
VLAN Tag Control	Tagged	Ports belonging to the specified VLAN tag all outgoing frames transmitted.
	Untagged	Ports belonging to the specified VLAN don't tag all outgoing frames transmitted.
VLAN Port	Port VID	This is the VLAN ID assigned to untagged frames that this port received.
	Acceptable frame type	You may choose to accept both tagged and untagged incoming frames or just tagged incoming frames on a port.
	Ingress filtering	If set, the switch discards incoming frames for VLANs that do not have this port as a member.

7.1.3 Port VLAN Trunking

Enable **VLAN Trunking** on a port to allow frames belonging to unknown VLAN groups to pass through that port. This is useful if you want to set up VLAN groups on end devices without having to configure the same VLAN groups on intermediary devices.

Refer to the following figure. Suppose you want to create VLAN groups 1 and 2 (V1 and V2) on devices A and B. Without **VLAN Trunking**, you must configure VLAN groups 1 and 2 on all intermediary switches C, D and E; otherwise they will drop frames with unknown VLAN group tags. However, with **VLAN Trunking** enabled on a port(s) in each intermediary switch you only need to create VLAN groups in the end devices (A and B). C, D and E automatically allow frames with VLAN group tags 1 and 2 (VLAN groups that are unknown to those switches) to pass through their VLAN trunking port(s).

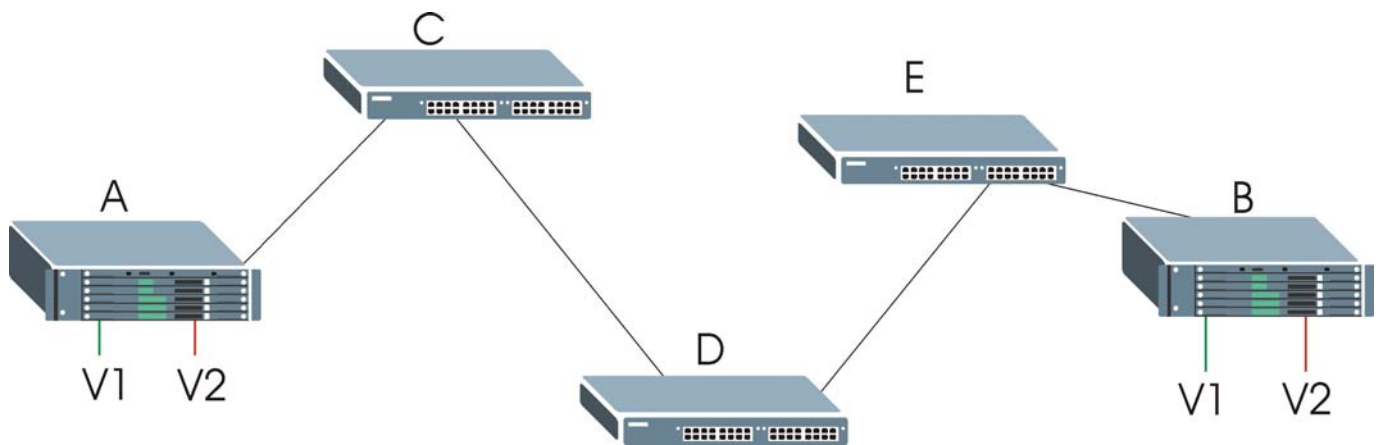

Figure 7-1 Port VLAN Trunking

7.2 802.1Q VLAN

Follow the steps below to set the **802.1Q VLAN Type** on the switch.

Step 1. Select **802.1Q** as the **VLAN Type** in the **Switch Setup** screen (under **Basic Setting**) and click **Apply**.

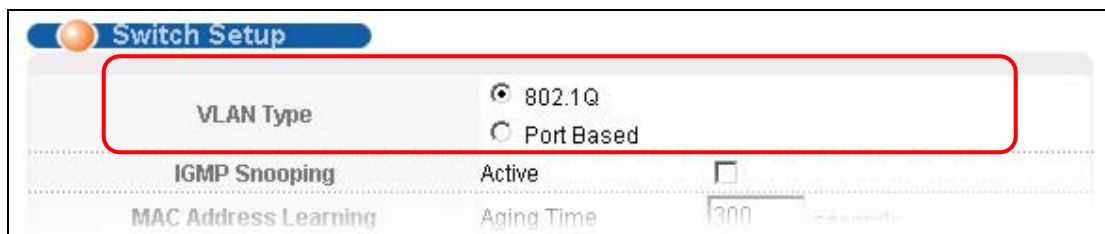

Figure 7-2 Selecting a VLAN Type

Step 2. Click **VLAN** under **Advanced Application** to display the **VLAN Status** screen as shown next.

VLAN Status

[VLAN Port Setting](#)

[Static VLAN](#)

The Number Of VLAN = 1

Index	VID	Port Number														Elapsed Time	Status	
		2	4	6	8	10	12	14	16	18	20	22	24	26	28			
		1	3	5	7	9	11	13	15	17	19	21	23	25	27			
1	1	U	U	U	U	U	U	U	U	U	U	U	U	U	U	U	0:01:34	Static

Poll Interval(s)

Change Pages

Figure 7-3 802.1Q VLAN Status

The following table describes the labels in this screen.

Table 7-2 802.1Q VLAN Status

LABEL	DESCRIPTION
The Number of VLAN	This is the number of VLANs configured on the switch.
Index	This is the VLAN index number.
VID	VID is the PVID, the Port VLAN ID assigned to untagged frames or priority-tagged frames received on this port that you configure in the VLAN Port Setting screen.
Port Number	This column displays the ports that are participating in a VLAN. A tagged port is marked as T , an untagged port is marked as U and ports not participating in a VLAN are marked as “-”.
Elapsed Time	This field shows how long it has been since a normal VLAN was registered or a static VLAN was set up.
Status	This field shows how this VLAN was added to the switch; dynamically using GVRP or statically, that is, added as a permanent entry.
Poll Interval(s)	The text box displays how often (in seconds) this screen refreshes. You may change the refresh interval by typing a new number in the text box and then clicking Set Interval .
Stop	Click Stop to halt polling statistics.

Table 7-2 802.1Q VLAN Status

LABEL	DESCRIPTION
Previous/Next Page	Click one of these buttons to show the previous/next screen if all status information cannot be seen in one screen.

7.2.1 802.1Q VLAN Port Settings

To configure the 802.1Q VLAN settings on a port, click the **VLAN Port Settings** link in the **VLAN Status** screen.

Port	Ingress Check	PVID	GVRP	Acceptable Frame Type	VLAN Trunking
1	<input type="checkbox"/>	1	<input type="checkbox"/>	All	<input type="checkbox"/>
2	<input type="checkbox"/>	1	<input type="checkbox"/>	All	<input type="checkbox"/>
3	<input type="checkbox"/>	1	<input type="checkbox"/>	All	<input type="checkbox"/>
4	<input type="checkbox"/>	1	<input type="checkbox"/>	All	<input type="checkbox"/>
5	<input type="checkbox"/>	1	<input type="checkbox"/>	All	<input type="checkbox"/>
6	<input type="checkbox"/>	1	<input type="checkbox"/>	All	<input type="checkbox"/>
7	<input type="checkbox"/>	1	<input type="checkbox"/>	All	<input type="checkbox"/>
8	<input type="checkbox"/>	1	<input type="checkbox"/>	All	<input type="checkbox"/>
9	<input type="checkbox"/>	1	<input type="checkbox"/>	All	<input type="checkbox"/>
10	<input type="checkbox"/>	1	<input type="checkbox"/>	All	<input type="checkbox"/>
11	<input type="checkbox"/>	1	<input type="checkbox"/>	All	<input type="checkbox"/>
12	<input type="checkbox"/>	1	<input type="checkbox"/>	All	<input type="checkbox"/>
13	<input type="checkbox"/>	1	<input type="checkbox"/>	All	<input type="checkbox"/>
14	<input type="checkbox"/>	1	<input type="checkbox"/>	All	<input type="checkbox"/>
15	<input type="checkbox"/>	1	<input type="checkbox"/>	All	<input type="checkbox"/>
16	<input type="checkbox"/>	1	<input type="checkbox"/>	All	<input type="checkbox"/>
17	<input type="checkbox"/>	1	<input type="checkbox"/>	All	<input type="checkbox"/>
18	<input type="checkbox"/>	1	<input type="checkbox"/>	All	<input type="checkbox"/>
19	<input type="checkbox"/>	1	<input type="checkbox"/>	All	<input type="checkbox"/>
20	<input type="checkbox"/>	1	<input type="checkbox"/>	All	<input type="checkbox"/>
21	<input type="checkbox"/>	1	<input type="checkbox"/>	All	<input type="checkbox"/>
22	<input type="checkbox"/>	1	<input type="checkbox"/>	All	<input type="checkbox"/>
23	<input type="checkbox"/>	1	<input type="checkbox"/>	All	<input type="checkbox"/>
24	<input type="checkbox"/>	1	<input type="checkbox"/>	All	<input type="checkbox"/>
25	<input type="checkbox"/>	1	<input type="checkbox"/>	All	<input type="checkbox"/>
26	<input type="checkbox"/>	1	<input type="checkbox"/>	All	<input type="checkbox"/>
27	<input type="checkbox"/>	1	<input type="checkbox"/>	All	<input type="checkbox"/>
28	<input type="checkbox"/>	1	<input type="checkbox"/>	All	<input type="checkbox"/>

Figure 7-4 802.1Q VLAN Port Settings

The following table describes the labels in this screen.

Table 7-3 802.1Q VLAN Port Settings

LABEL	DESCRIPTION
GVRP	GVRP (GARP VLAN Registration Protocol) is a registration protocol that defines a way for switches to dynamically register necessary VLAN members on ports across the network. Select this check box to permit VLAN groups beyond the local switch.
Port Isolation	Port Isolation allows each port to communicate with the CPU port, uplink ports and stacking ports but not communicate with each other. This option is the most limiting but also the most secure.
Port	This field displays the port numbers.
Ingress Check	If this check box is selected for a port, the device discards incoming frames for VLANs that do not include this port in its member set.
PVID	Each port on the switch is capable of passing tagged or untagged frames. To forward a frame from an 802.1Q VLAN-unaware switch to an 802.1Q VLAN-aware switch, the switch first decides where to forward the frame, and then inserts a VLAN tag reflecting the default ingress port's VLAN ID, the PVID. The default PVID is VLAN 1 for all ports, but this can be changed to any number between 1 and 4094.
GVRP	Select this check box to permit VLANs groups beyond the local switch on this port. GVRP (GARP VLAN Registration Protocol) is a registration protocol that defines a way for switches to register necessary VLAN members on ports across the network.
Acceptable Frame Type	Specify the type of frames allowed on a port. Choices are All and Tag Only . Select All to accept all frames with untagged or tagged frames on this port. This is the default setting. Select Tag Only to accept only tagged frames on this port. All untagged frames are dropped.
VLAN Trunking	Enable VLAN Trunking on ports connected to other switches or routers (but not ports directly connected to end users) to allow frames belonging to unknown VLAN groups to pass through the switch.
Apply	Click Apply to save the changes.
Cancel	Click Cancel to start configuring the screen again.

7.2.2 802.1Q Static VLAN

You can dynamically have a port join a VLAN group using GVRP, permanently assign a port to be a member of a VLAN group or prohibit a port from joining a VLAN group in this screen. Click **Static VLAN** in the **VLAN Status** screen to display the screen as shown next.

Static VLAN
VLAN Status

ACTIVE

Name

VLAN Group ID

Port	Control			Tagging
1	<input checked="" type="radio"/> Normal	<input type="radio"/> Fixed	<input type="radio"/> Forbidden	<input checked="" type="checkbox"/> Tx Tagging
2	<input checked="" type="radio"/> Normal	<input type="radio"/> Fixed	<input type="radio"/> Forbidden	<input checked="" type="checkbox"/> Tx Tagging
3	<input checked="" type="radio"/> Normal	<input type="radio"/> Fixed	<input type="radio"/> Forbidden	<input checked="" type="checkbox"/> Tx Tagging
4	<input checked="" type="radio"/> Normal	<input type="radio"/> Fixed	<input type="radio"/> Forbidden	<input checked="" type="checkbox"/> Tx Tagging
5	<input checked="" type="radio"/> Normal	<input type="radio"/> Fixed	<input type="radio"/> Forbidden	<input checked="" type="checkbox"/> Tx Tagging
6	<input checked="" type="radio"/> Normal	<input type="radio"/> Fixed	<input type="radio"/> Forbidden	<input checked="" type="checkbox"/> Tx Tagging
7	<input checked="" type="radio"/> Normal	<input type="radio"/> Fixed	<input type="radio"/> Forbidden	<input checked="" type="checkbox"/> Tx Tagging
8	<input checked="" type="radio"/> Normal	<input type="radio"/> Fixed	<input type="radio"/> Forbidden	<input checked="" type="checkbox"/> Tx Tagging
9	<input checked="" type="radio"/> Normal	<input type="radio"/> Fixed	<input type="radio"/> Forbidden	<input checked="" type="checkbox"/> Tx Tagging
10	<input checked="" type="radio"/> Normal	<input type="radio"/> Fixed	<input type="radio"/> Forbidden	<input checked="" type="checkbox"/> Tx Tagging
11	<input checked="" type="radio"/> Normal	<input type="radio"/> Fixed	<input type="radio"/> Forbidden	<input checked="" type="checkbox"/> Tx Tagging
12	<input checked="" type="radio"/> Normal	<input type="radio"/> Fixed	<input type="radio"/> Forbidden	<input checked="" type="checkbox"/> Tx Tagging
13	<input checked="" type="radio"/> Normal	<input type="radio"/> Fixed	<input type="radio"/> Forbidden	<input checked="" type="checkbox"/> Tx Tagging
14	<input checked="" type="radio"/> Normal	<input type="radio"/> Fixed	<input type="radio"/> Forbidden	<input checked="" type="checkbox"/> Tx Tagging
15	<input checked="" type="radio"/> Normal	<input type="radio"/> Fixed	<input type="radio"/> Forbidden	<input checked="" type="checkbox"/> Tx Tagging
16	<input checked="" type="radio"/> Normal	<input type="radio"/> Fixed	<input type="radio"/> Forbidden	<input checked="" type="checkbox"/> Tx Tagging
17	<input checked="" type="radio"/> Normal	<input type="radio"/> Fixed	<input type="radio"/> Forbidden	<input checked="" type="checkbox"/> Tx Tagging
18	<input checked="" type="radio"/> Normal	<input type="radio"/> Fixed	<input type="radio"/> Forbidden	<input checked="" type="checkbox"/> Tx Tagging
19	<input checked="" type="radio"/> Normal	<input type="radio"/> Fixed	<input type="radio"/> Forbidden	<input checked="" type="checkbox"/> Tx Tagging
20	<input checked="" type="radio"/> Normal	<input type="radio"/> Fixed	<input type="radio"/> Forbidden	<input checked="" type="checkbox"/> Tx Tagging
21	<input checked="" type="radio"/> Normal	<input type="radio"/> Fixed	<input type="radio"/> Forbidden	<input checked="" type="checkbox"/> Tx Tagging
22	<input checked="" type="radio"/> Normal	<input type="radio"/> Fixed	<input type="radio"/> Forbidden	<input checked="" type="checkbox"/> Tx Tagging
23	<input checked="" type="radio"/> Normal	<input type="radio"/> Fixed	<input type="radio"/> Forbidden	<input checked="" type="checkbox"/> Tx Tagging
24	<input checked="" type="radio"/> Normal	<input type="radio"/> Fixed	<input type="radio"/> Forbidden	<input checked="" type="checkbox"/> Tx Tagging
25	<input checked="" type="radio"/> Normal	<input type="radio"/> Fixed	<input type="radio"/> Forbidden	<input checked="" type="checkbox"/> Tx Tagging
26	<input checked="" type="radio"/> Normal	<input type="radio"/> Fixed	<input type="radio"/> Forbidden	<input checked="" type="checkbox"/> Tx Tagging
27	<input checked="" type="radio"/> Normal	<input type="radio"/> Fixed	<input type="radio"/> Forbidden	<input checked="" type="checkbox"/> Tx Tagging
28	<input checked="" type="radio"/> Normal	<input type="radio"/> Fixed	<input type="radio"/> Forbidden	<input checked="" type="checkbox"/> Tx Tagging

VID	Active	Name	Delete
1	Yes	1	<input type="checkbox"/>

Figure 7-5 802.1Q Static VLAN

The following table describes the labels in this screen.

Table 7-4 802.1Q Static VLAN

LABEL	DESCRIPTION
Active	Select this check box to enable the VLAN.
Name	Enter a descriptive name for this VLAN group for identification purposes.
VLAN Group ID	Enter the VLAN ID for this static VLAN entry; the valid range is between 1 and 4094.
Port	The port number identifies the port you are configuring. 25 and 26 are the stacking ports. Ports 27 and 28 are the uplink ports.
Control	Select Normal for the port to dynamically join this VLAN group using GVRP. This is the default selection. Select Fixed for the port to be a permanent member of this VLAN group. Select Forbidden if you want to prohibit the port from joining this VLAN group.
Tagging	Select TX Tagging if you want the port to tag all outgoing frames transmitted with this VLAN Group ID.
Add	Click Add to save the new rule to the switch. It then displays in the summary table at the bottom of the screen.
Cancel	Click Cancel to reset the fields to your previous configuration.
Clear	Click Clear to clear the fields to the factory defaults.

7.2.3 Viewing and Editing VLAN Settings

To view a summary of the VLAN configuration, scroll down to the summary table at the bottom of the **Static VLAN** screen.

To change the settings of a rule, click a number in the **VID** field.

VID	Active	Name	Delete
<u>1</u>	Yes	1	<input type="checkbox"/>

Delete Cancel

Figure 7-6 Static VLAN: Summary Table

The following table describes the labels in this screen.

Table 7-5 Static VLAN: Summary Table

LABEL	DESCRIPTION
VID	This field displays the ID number of the VLAN group. Click the number to edit the VLAN settings.
Active	This field indicates whether the VLAN settings are enabled (Yes) or disabled (No).
Name	This field displays the descriptive name for this VLAN group.
Delete	Click Delete to remove the selected entry from the summary table.
Cancel	Click Cancel to clear the Delete check boxes.

VID1 Example Screen

Static VLAN
VLAN Status

ACTIVE

Name

VLAN Group ID

Port	Control			Tagging
1	<input type="radio"/> Normal	<input checked="" type="radio"/> Fixed	<input type="radio"/> Forbidden	<input checked="" type="checkbox"/> Tx Tagging
2	<input type="radio"/> Normal	<input checked="" type="radio"/> Fixed	<input type="radio"/> Forbidden	<input checked="" type="checkbox"/> Tx Tagging
3	<input type="radio"/> Normal	<input checked="" type="radio"/> Fixed	<input type="radio"/> Forbidden	<input checked="" type="checkbox"/> Tx Tagging
4	<input type="radio"/> Normal	<input checked="" type="radio"/> Fixed	<input type="radio"/> Forbidden	<input checked="" type="checkbox"/> Tx Tagging
5	<input type="radio"/> Normal	<input checked="" type="radio"/> Fixed	<input type="radio"/> Forbidden	<input checked="" type="checkbox"/> Tx Tagging
6	<input type="radio"/> Normal	<input checked="" type="radio"/> Fixed	<input type="radio"/> Forbidden	<input checked="" type="checkbox"/> Tx Tagging
7	<input type="radio"/> Normal	<input checked="" type="radio"/> Fixed	<input type="radio"/> Forbidden	<input checked="" type="checkbox"/> Tx Tagging
8	<input type="radio"/> Normal	<input checked="" type="radio"/> Fixed	<input type="radio"/> Forbidden	<input checked="" type="checkbox"/> Tx Tagging
9	<input type="radio"/> Normal	<input checked="" type="radio"/> Fixed	<input type="radio"/> Forbidden	<input checked="" type="checkbox"/> Tx Tagging
10	<input type="radio"/> Normal	<input checked="" type="radio"/> Fixed	<input type="radio"/> Forbidden	<input checked="" type="checkbox"/> Tx Tagging
11	<input type="radio"/> Normal	<input checked="" type="radio"/> Fixed	<input type="radio"/> Forbidden	<input checked="" type="checkbox"/> Tx Tagging
12	<input type="radio"/> Normal	<input checked="" type="radio"/> Fixed	<input type="radio"/> Forbidden	<input checked="" type="checkbox"/> Tx Tagging
13	<input type="radio"/> Normal	<input checked="" type="radio"/> Fixed	<input type="radio"/> Forbidden	<input checked="" type="checkbox"/> Tx Tagging
14	<input type="radio"/> Normal	<input checked="" type="radio"/> Fixed	<input type="radio"/> Forbidden	<input checked="" type="checkbox"/> Tx Tagging
15	<input type="radio"/> Normal	<input checked="" type="radio"/> Fixed	<input type="radio"/> Forbidden	<input checked="" type="checkbox"/> Tx Tagging
16	<input type="radio"/> Normal	<input checked="" type="radio"/> Fixed	<input type="radio"/> Forbidden	<input checked="" type="checkbox"/> Tx Tagging
17	<input type="radio"/> Normal	<input checked="" type="radio"/> Fixed	<input type="radio"/> Forbidden	<input checked="" type="checkbox"/> Tx Tagging
18	<input type="radio"/> Normal	<input checked="" type="radio"/> Fixed	<input type="radio"/> Forbidden	<input checked="" type="checkbox"/> Tx Tagging
19	<input type="radio"/> Normal	<input checked="" type="radio"/> Fixed	<input type="radio"/> Forbidden	<input checked="" type="checkbox"/> Tx Tagging
20	<input type="radio"/> Normal	<input checked="" type="radio"/> Fixed	<input type="radio"/> Forbidden	<input checked="" type="checkbox"/> Tx Tagging
21	<input type="radio"/> Normal	<input checked="" type="radio"/> Fixed	<input type="radio"/> Forbidden	<input checked="" type="checkbox"/> Tx Tagging
22	<input checked="" type="radio"/> Normal	<input type="radio"/> Fixed	<input type="radio"/> Forbidden	<input checked="" type="checkbox"/> Tx Tagging
23	<input type="radio"/> Normal	<input checked="" type="radio"/> Fixed	<input type="radio"/> Forbidden	<input checked="" type="checkbox"/> Tx Tagging
24	<input type="radio"/> Normal	<input checked="" type="radio"/> Fixed	<input type="radio"/> Forbidden	<input checked="" type="checkbox"/> Tx Tagging
25	<input type="radio"/> Normal	<input checked="" type="radio"/> Fixed	<input type="radio"/> Forbidden	<input checked="" type="checkbox"/> Tx Tagging
26	<input type="radio"/> Normal	<input checked="" type="radio"/> Fixed	<input type="radio"/> Forbidden	<input checked="" type="checkbox"/> Tx Tagging
27	<input type="radio"/> Normal	<input checked="" type="radio"/> Fixed	<input type="radio"/> Forbidden	<input checked="" type="checkbox"/> Tx Tagging
28	<input type="radio"/> Normal	<input checked="" type="radio"/> Fixed	<input type="radio"/> Forbidden	<input checked="" type="checkbox"/> Tx Tagging

VID	Active	Name	Delete
1	Yes	VID1	<input type="checkbox"/>

Figure 7-7 VID1 Example Screen

7.3 Introduction to Port-based VLANs

Port-based VLANs are VLANs where the packet forwarding decision is based on the destination MAC address and its associated port.

Port-based VLANs require allowed outgoing ports to be defined for each port. Therefore, if you wish to allow two subscriber ports to talk to each other, for example, between conference rooms in a hotel, you must define the egress (an egress port is an outgoing port, that is, a port through which a data packet leaves) for both ports.

Port-based VLANs are specific only to the switch on which they were created.

The port-based VLAN setup screen is shown next. The **CPU** management port forms a VLAN with all Ethernet ports.

7.3.1 Configuring a Port-based VLAN

Select **Port Based** as the **VLAN Type** in the **Switch Setup** screen under **Basic Setting** and then click **VLAN** under **Advanced Application** to display the next screen.

Port Based VLAN Setup

Setting Wizard All connected ▾ Apply

Incoming

	1	2	3	4	5	6	7	8	9	10	11	12	13	14	15	16	17	18	19	20	21	22	23	24	25	26	27	28		
1	<input checked="" type="checkbox"/>	<input checked="" type="checkbox"/>	<input checked="" type="checkbox"/>	<input checked="" type="checkbox"/>	<input checked="" type="checkbox"/>	<input checked="" type="checkbox"/>	<input checked="" type="checkbox"/>	<input checked="" type="checkbox"/>	<input checked="" type="checkbox"/>	<input checked="" type="checkbox"/>	<input checked="" type="checkbox"/>	<input checked="" type="checkbox"/>	<input checked="" type="checkbox"/>	<input checked="" type="checkbox"/>	<input checked="" type="checkbox"/>	<input checked="" type="checkbox"/>	<input checked="" type="checkbox"/>	<input checked="" type="checkbox"/>	<input checked="" type="checkbox"/>	<input checked="" type="checkbox"/>	<input checked="" type="checkbox"/>	<input checked="" type="checkbox"/>	<input checked="" type="checkbox"/>	<input checked="" type="checkbox"/>	<input checked="" type="checkbox"/>	<input checked="" type="checkbox"/>	<input checked="" type="checkbox"/>	<input checked="" type="checkbox"/>	<input checked="" type="checkbox"/>	1
2	<input checked="" type="checkbox"/>	<input checked="" type="checkbox"/>	<input checked="" type="checkbox"/>	<input checked="" type="checkbox"/>	<input checked="" type="checkbox"/>	<input checked="" type="checkbox"/>	<input checked="" type="checkbox"/>	<input checked="" type="checkbox"/>	<input checked="" type="checkbox"/>	<input checked="" type="checkbox"/>	<input checked="" type="checkbox"/>	<input checked="" type="checkbox"/>	<input checked="" type="checkbox"/>	<input checked="" type="checkbox"/>	<input checked="" type="checkbox"/>	<input checked="" type="checkbox"/>	<input checked="" type="checkbox"/>	<input checked="" type="checkbox"/>	<input checked="" type="checkbox"/>	<input checked="" type="checkbox"/>	<input checked="" type="checkbox"/>	<input checked="" type="checkbox"/>	<input checked="" type="checkbox"/>	<input checked="" type="checkbox"/>	<input checked="" type="checkbox"/>	<input checked="" type="checkbox"/>	<input checked="" type="checkbox"/>	<input checked="" type="checkbox"/>	<input checked="" type="checkbox"/>	2
3	<input checked="" type="checkbox"/>	<input checked="" type="checkbox"/>	<input checked="" type="checkbox"/>	<input checked="" type="checkbox"/>	<input checked="" type="checkbox"/>	<input checked="" type="checkbox"/>	<input checked="" type="checkbox"/>	<input checked="" type="checkbox"/>	<input checked="" type="checkbox"/>	<input checked="" type="checkbox"/>	<input checked="" type="checkbox"/>	<input checked="" type="checkbox"/>	<input checked="" type="checkbox"/>	<input checked="" type="checkbox"/>	<input checked="" type="checkbox"/>	<input checked="" type="checkbox"/>	<input checked="" type="checkbox"/>	<input checked="" type="checkbox"/>	<input checked="" type="checkbox"/>	<input checked="" type="checkbox"/>	<input checked="" type="checkbox"/>	<input checked="" type="checkbox"/>	<input checked="" type="checkbox"/>	<input checked="" type="checkbox"/>	<input checked="" type="checkbox"/>	<input checked="" type="checkbox"/>	<input checked="" type="checkbox"/>	<input checked="" type="checkbox"/>	<input checked="" type="checkbox"/>	3
4	<input checked="" type="checkbox"/>	<input checked="" type="checkbox"/>	<input checked="" type="checkbox"/>	<input checked="" type="checkbox"/>	<input checked="" type="checkbox"/>	<input checked="" type="checkbox"/>	<input checked="" type="checkbox"/>	<input checked="" type="checkbox"/>	<input checked="" type="checkbox"/>	<input checked="" type="checkbox"/>	<input checked="" type="checkbox"/>	<input checked="" type="checkbox"/>	<input checked="" type="checkbox"/>	<input checked="" type="checkbox"/>	<input checked="" type="checkbox"/>	<input checked="" type="checkbox"/>	<input checked="" type="checkbox"/>	<input checked="" type="checkbox"/>	<input checked="" type="checkbox"/>	<input checked="" type="checkbox"/>	<input checked="" type="checkbox"/>	<input checked="" type="checkbox"/>	<input checked="" type="checkbox"/>	<input checked="" type="checkbox"/>	<input checked="" type="checkbox"/>	<input checked="" type="checkbox"/>	<input checked="" type="checkbox"/>	<input checked="" type="checkbox"/>	<input checked="" type="checkbox"/>	4
5	<input checked="" type="checkbox"/>	<input checked="" type="checkbox"/>	<input checked="" type="checkbox"/>	<input checked="" type="checkbox"/>	<input checked="" type="checkbox"/>	<input checked="" type="checkbox"/>	<input checked="" type="checkbox"/>	<input checked="" type="checkbox"/>	<input checked="" type="checkbox"/>	<input checked="" type="checkbox"/>	<input checked="" type="checkbox"/>	<input checked="" type="checkbox"/>	<input checked="" type="checkbox"/>	<input checked="" type="checkbox"/>	<input checked="" type="checkbox"/>	<input checked="" type="checkbox"/>	<input checked="" type="checkbox"/>	<input checked="" type="checkbox"/>	<input checked="" type="checkbox"/>	<input checked="" type="checkbox"/>	<input checked="" type="checkbox"/>	<input checked="" type="checkbox"/>	<input checked="" type="checkbox"/>	<input checked="" type="checkbox"/>	<input checked="" type="checkbox"/>	<input checked="" type="checkbox"/>	<input checked="" type="checkbox"/>	<input checked="" type="checkbox"/>	<input checked="" type="checkbox"/>	5
6	<input checked="" type="checkbox"/>	<input checked="" type="checkbox"/>	<input checked="" type="checkbox"/>	<input checked="" type="checkbox"/>	<input checked="" type="checkbox"/>	<input checked="" type="checkbox"/>	<input checked="" type="checkbox"/>	<input checked="" type="checkbox"/>	<input checked="" type="checkbox"/>	<input checked="" type="checkbox"/>	<input checked="" type="checkbox"/>	<input checked="" type="checkbox"/>	<input checked="" type="checkbox"/>	<input checked="" type="checkbox"/>	<input checked="" type="checkbox"/>	<input checked="" type="checkbox"/>	<input checked="" type="checkbox"/>	<input checked="" type="checkbox"/>	<input checked="" type="checkbox"/>	<input checked="" type="checkbox"/>	<input checked="" type="checkbox"/>	<input checked="" type="checkbox"/>	<input checked="" type="checkbox"/>	<input checked="" type="checkbox"/>	<input checked="" type="checkbox"/>	<input checked="" type="checkbox"/>	<input checked="" type="checkbox"/>	<input checked="" type="checkbox"/>	<input checked="" type="checkbox"/>	6
7	<input checked="" type="checkbox"/>	<input checked="" type="checkbox"/>	<input checked="" type="checkbox"/>	<input checked="" type="checkbox"/>	<input checked="" type="checkbox"/>	<input checked="" type="checkbox"/>	<input checked="" type="checkbox"/>	<input checked="" type="checkbox"/>	<input checked="" type="checkbox"/>	<input checked="" type="checkbox"/>	<input checked="" type="checkbox"/>	<input checked="" type="checkbox"/>	<input checked="" type="checkbox"/>	<input checked="" type="checkbox"/>	<input checked="" type="checkbox"/>	<input checked="" type="checkbox"/>	<input checked="" type="checkbox"/>	<input checked="" type="checkbox"/>	<input checked="" type="checkbox"/>	<input checked="" type="checkbox"/>	<input checked="" type="checkbox"/>	<input checked="" type="checkbox"/>	<input checked="" type="checkbox"/>	<input checked="" type="checkbox"/>	<input checked="" type="checkbox"/>	<input checked="" type="checkbox"/>	<input checked="" type="checkbox"/>	<input checked="" type="checkbox"/>	<input checked="" type="checkbox"/>	7
8	<input checked="" type="checkbox"/>	<input checked="" type="checkbox"/>	<input checked="" type="checkbox"/>	<input checked="" type="checkbox"/>	<input checked="" type="checkbox"/>	<input checked="" type="checkbox"/>	<input checked="" type="checkbox"/>	<input checked="" type="checkbox"/>	<input checked="" type="checkbox"/>	<input checked="" type="checkbox"/>	<input checked="" type="checkbox"/>	<input checked="" type="checkbox"/>	<input checked="" type="checkbox"/>	<input checked="" type="checkbox"/>	<input checked="" type="checkbox"/>	<input checked="" type="checkbox"/>	<input checked="" type="checkbox"/>	<input checked="" type="checkbox"/>	<input checked="" type="checkbox"/>	<input checked="" type="checkbox"/>	<input checked="" type="checkbox"/>	<input checked="" type="checkbox"/>	<input checked="" type="checkbox"/>	<input checked="" type="checkbox"/>	<input checked="" type="checkbox"/>	<input checked="" type="checkbox"/>	<input checked="" type="checkbox"/>	<input checked="" type="checkbox"/>	<input checked="" type="checkbox"/>	8
9	<input checked="" type="checkbox"/>	<input checked="" type="checkbox"/>	<input checked="" type="checkbox"/>	<input checked="" type="checkbox"/>	<input checked="" type="checkbox"/>	<input checked="" type="checkbox"/>	<input checked="" type="checkbox"/>	<input checked="" type="checkbox"/>	<input checked="" type="checkbox"/>	<input checked="" type="checkbox"/>	<input checked="" type="checkbox"/>	<input checked="" type="checkbox"/>	<input checked="" type="checkbox"/>	<input checked="" type="checkbox"/>	<input checked="" type="checkbox"/>	<input checked="" type="checkbox"/>	<input checked="" type="checkbox"/>	<input checked="" type="checkbox"/>	<input checked="" type="checkbox"/>	<input checked="" type="checkbox"/>	<input checked="" type="checkbox"/>	<input checked="" type="checkbox"/>	<input checked="" type="checkbox"/>	<input checked="" type="checkbox"/>	<input checked="" type="checkbox"/>	<input checked="" type="checkbox"/>	<input checked="" type="checkbox"/>	<input checked="" type="checkbox"/>	<input checked="" type="checkbox"/>	9
10	<input checked="" type="checkbox"/>	<input checked="" type="checkbox"/>	<input checked="" type="checkbox"/>	<input checked="" type="checkbox"/>	<input checked="" type="checkbox"/>	<input checked="" type="checkbox"/>	<input checked="" type="checkbox"/>	<input checked="" type="checkbox"/>	<input checked="" type="checkbox"/>	<input checked="" type="checkbox"/>	<input checked="" type="checkbox"/>	<input checked="" type="checkbox"/>	<input checked="" type="checkbox"/>	<input checked="" type="checkbox"/>	<input checked="" type="checkbox"/>	<input checked="" type="checkbox"/>	<input checked="" type="checkbox"/>	<input checked="" type="checkbox"/>	<input checked="" type="checkbox"/>	<input checked="" type="checkbox"/>	<input checked="" type="checkbox"/>	<input checked="" type="checkbox"/>	<input checked="" type="checkbox"/>	<input checked="" type="checkbox"/>	<input checked="" type="checkbox"/>	<input checked="" type="checkbox"/>	<input checked="" type="checkbox"/>	<input checked="" type="checkbox"/>	<input checked="" type="checkbox"/>	10
11	<input checked="" type="checkbox"/>	<input checked="" type="checkbox"/>	<input checked="" type="checkbox"/>	<input checked="" type="checkbox"/>	<input checked="" type="checkbox"/>	<input checked="" type="checkbox"/>	<input checked="" type="checkbox"/>	<input checked="" type="checkbox"/>	<input checked="" type="checkbox"/>	<input checked="" type="checkbox"/>	<input checked="" type="checkbox"/>	<input checked="" type="checkbox"/>	<input checked="" type="checkbox"/>	<input checked="" type="checkbox"/>	<input checked="" type="checkbox"/>	<input checked="" type="checkbox"/>	<input checked="" type="checkbox"/>	<input checked="" type="checkbox"/>	<input checked="" type="checkbox"/>	<input checked="" type="checkbox"/>	<input checked="" type="checkbox"/>	<input checked="" type="checkbox"/>	<input checked="" type="checkbox"/>	<input checked="" type="checkbox"/>	<input checked="" type="checkbox"/>	<input checked="" type="checkbox"/>	<input checked="" type="checkbox"/>	<input checked="" type="checkbox"/>	<input checked="" type="checkbox"/>	11
12	<input checked="" type="checkbox"/>	<input checked="" type="checkbox"/>	<input checked="" type="checkbox"/>	<input checked="" type="checkbox"/>	<input checked="" type="checkbox"/>	<input checked="" type="checkbox"/>	<input checked="" type="checkbox"/>	<input checked="" type="checkbox"/>	<input checked="" type="checkbox"/>	<input checked="" type="checkbox"/>	<input checked="" type="checkbox"/>	<input checked="" type="checkbox"/>	<input checked="" type="checkbox"/>	<input checked="" type="checkbox"/>	<input checked="" type="checkbox"/>	<input checked="" type="checkbox"/>	<input checked="" type="checkbox"/>	<input checked="" type="checkbox"/>	<input checked="" type="checkbox"/>	<input checked="" type="checkbox"/>	<input checked="" type="checkbox"/>	<input checked="" type="checkbox"/>	<input checked="" type="checkbox"/>	<input checked="" type="checkbox"/>	<input checked="" type="checkbox"/>	<input checked="" type="checkbox"/>	<input checked="" type="checkbox"/>	<input checked="" type="checkbox"/>	<input checked="" type="checkbox"/>	12
13	<input checked="" type="checkbox"/>	<input checked="" type="checkbox"/>	<input checked="" type="checkbox"/>	<input checked="" type="checkbox"/>	<input checked="" type="checkbox"/>	<input checked="" type="checkbox"/>	<input checked="" type="checkbox"/>	<input checked="" type="checkbox"/>	<input checked="" type="checkbox"/>	<input checked="" type="checkbox"/>	<input checked="" type="checkbox"/>	<input checked="" type="checkbox"/>	<input checked="" type="checkbox"/>	<input checked="" type="checkbox"/>	<input checked="" type="checkbox"/>	<input checked="" type="checkbox"/>	<input checked="" type="checkbox"/>	<input checked="" type="checkbox"/>	<input checked="" type="checkbox"/>	<input checked="" type="checkbox"/>	<input checked="" type="checkbox"/>	<input checked="" type="checkbox"/>	<input checked="" type="checkbox"/>	<input checked="" type="checkbox"/>	<input checked="" type="checkbox"/>	<input checked="" type="checkbox"/>	<input checked="" type="checkbox"/>	<input checked="" type="checkbox"/>	<input checked="" type="checkbox"/>	13
14	<input checked="" type="checkbox"/>	<input checked="" type="checkbox"/>	<input checked="" type="checkbox"/>	<input checked="" type="checkbox"/>	<input checked="" type="checkbox"/>	<input checked="" type="checkbox"/>	<input checked="" type="checkbox"/>	<input checked="" type="checkbox"/>	<input checked="" type="checkbox"/>	<input checked="" type="checkbox"/>	<input checked="" type="checkbox"/>	<input checked="" type="checkbox"/>	<input checked="" type="checkbox"/>	<input checked="" type="checkbox"/>	<input checked="" type="checkbox"/>	<input checked="" type="checkbox"/>	<input checked="" type="checkbox"/>	<input checked="" type="checkbox"/>	<input checked="" type="checkbox"/>	<input checked="" type="checkbox"/>	<input checked="" type="checkbox"/>	<input checked="" type="checkbox"/>	<input checked="" type="checkbox"/>	<input checked="" type="checkbox"/>	<input checked="" type="checkbox"/>	<input checked="" type="checkbox"/>	<input checked="" type="checkbox"/>	<input checked="" type="checkbox"/>	<input checked="" type="checkbox"/>	14
15	<input checked="" type="checkbox"/>	<input checked="" type="checkbox"/>	<input checked="" type="checkbox"/>	<input checked="" type="checkbox"/>	<input checked="" type="checkbox"/>	<input checked="" type="checkbox"/>	<input checked="" type="checkbox"/>	<input checked="" type="checkbox"/>	<input checked="" type="checkbox"/>	<input checked="" type="checkbox"/>	<input checked="" type="checkbox"/>	<input checked="" type="checkbox"/>	<input checked="" type="checkbox"/>	<input checked="" type="checkbox"/>	<input checked="" type="checkbox"/>	<input checked="" type="checkbox"/>	<input checked="" type="checkbox"/>	<input checked="" type="checkbox"/>	<input checked="" type="checkbox"/>	<input checked="" type="checkbox"/>	<input checked="" type="checkbox"/>	<input checked="" type="checkbox"/>	<input checked="" type="checkbox"/>	<input checked="" type="checkbox"/>	<input checked="" type="checkbox"/>	<input checked="" type="checkbox"/>	<input checked="" type="checkbox"/>	<input checked="" type="checkbox"/>	<input checked="" type="checkbox"/>	15
16	<input checked="" type="checkbox"/>	<input checked="" type="checkbox"/>	<input checked="" type="checkbox"/>	<input checked="" type="checkbox"/>	<input checked="" type="checkbox"/>	<input checked="" type="checkbox"/>	<input checked="" type="checkbox"/>	<input checked="" type="checkbox"/>	<input checked="" type="checkbox"/>	<input checked="" type="checkbox"/>	<input checked="" type="checkbox"/>	<input checked="" type="checkbox"/>	<input checked="" type="checkbox"/>	<input checked="" type="checkbox"/>	<input checked="" type="checkbox"/>	<input checked="" type="checkbox"/>	<input checked="" type="checkbox"/>	<input checked="" type="checkbox"/>	<input checked="" type="checkbox"/>	<input checked="" type="checkbox"/>	<input checked="" type="checkbox"/>	<input checked="" type="checkbox"/>	<input checked="" type="checkbox"/>	<input checked="" type="checkbox"/>	<input checked="" type="checkbox"/>	<input checked="" type="checkbox"/>	<input checked="" type="checkbox"/>	<input checked="" type="checkbox"/>	<input checked="" type="checkbox"/>	16
17	<input checked="" type="checkbox"/>	<input checked="" type="checkbox"/>	<input checked="" type="checkbox"/>	<input checked="" type="checkbox"/>	<input checked="" type="checkbox"/>	<input checked="" type="checkbox"/>	<input checked="" type="checkbox"/>	<input checked="" type="checkbox"/>	<input checked="" type="checkbox"/>	<input checked="" type="checkbox"/>	<input checked="" type="checkbox"/>	<input checked="" type="checkbox"/>	<input checked="" type="checkbox"/>	<input checked="" type="checkbox"/>	<input checked="" type="checkbox"/>	<input checked="" type="checkbox"/>	<input checked="" type="checkbox"/>	<input checked="" type="checkbox"/>	<input checked="" type="checkbox"/>	<input checked="" type="checkbox"/>	<input checked="" type="checkbox"/>	<input checked="" type="checkbox"/>	<input checked="" type="checkbox"/>	<input checked="" type="checkbox"/>	<input checked="" type="checkbox"/>	<input checked="" type="checkbox"/>	<input checked="" type="checkbox"/>	<input checked="" type="checkbox"/>	<input checked="" type="checkbox"/>	17
18	<input checked="" type="checkbox"/>	<input checked="" type="checkbox"/>	<input checked="" type="checkbox"/>	<input checked="" type="checkbox"/>	<input checked="" type="checkbox"/>	<input checked="" type="checkbox"/>	<input checked="" type="checkbox"/>	<input checked="" type="checkbox"/>	<input checked="" type="checkbox"/>	<input checked="" type="checkbox"/>	<input checked="" type="checkbox"/>	<input checked="" type="checkbox"/>	<input checked="" type="checkbox"/>	<input checked="" type="checkbox"/>	<input checked="" type="checkbox"/>	<input checked="" type="checkbox"/>	<input checked="" type="checkbox"/>	<input checked="" type="checkbox"/>	<input checked="" type="checkbox"/>	<input checked="" type="checkbox"/>	<input checked="" type="checkbox"/>	<input checked="" type="checkbox"/>	<input checked="" type="checkbox"/>	<input checked="" type="checkbox"/>	<input checked="" type="checkbox"/>	<input checked="" type="checkbox"/>	<input checked="" type="checkbox"/>	<input checked="" type="checkbox"/>	<input checked="" type="checkbox"/>	18
19	<input checked="" type="checkbox"/>	<input checked="" type="checkbox"/>	<input checked="" type="checkbox"/>	<input checked="" type="checkbox"/>	<input checked="" type="checkbox"/>	<input checked="" type="checkbox"/>	<input checked="" type="checkbox"/>	<input checked="" type="checkbox"/>	<input checked="" type="checkbox"/>	<input checked="" type="checkbox"/>	<input checked="" type="checkbox"/>	<input checked="" type="checkbox"/>	<input checked="" type="checkbox"/>	<input checked="" type="checkbox"/>	<input checked="" type="checkbox"/>	<input checked="" type="checkbox"/>	<input checked="" type="checkbox"/>	<input checked="" type="checkbox"/>	<input checked="" type="checkbox"/>	<input checked="" type="checkbox"/>	<input checked="" type="checkbox"/>	<input checked="" type="checkbox"/>	<input checked="" type="checkbox"/>	<input checked="" type="checkbox"/>	<input checked="" type="checkbox"/>	<input checked="" type="checkbox"/>	<input checked="" type="checkbox"/>	<input checked="" type="checkbox"/>	<input checked="" type="checkbox"/>	19
20	<input checked="" type="checkbox"/>	<input checked="" type="checkbox"/>	<input checked="" type="checkbox"/>	<input checked="" type="checkbox"/>	<input checked="" type="checkbox"/>	<input checked="" type="checkbox"/>	<input checked="" type="checkbox"/>	<input checked="" type="checkbox"/>	<input checked="" type="checkbox"/>	<input checked="" type="checkbox"/>	<input checked="" type="checkbox"/>	<input checked="" type="checkbox"/>	<input checked="" type="checkbox"/>	<input checked="" type="checkbox"/>	<input checked="" type="checkbox"/>	<input checked="" type="checkbox"/>	<input checked="" type="checkbox"/>	<input checked="" type="checkbox"/>	<input checked="" type="checkbox"/>	<input checked="" type="checkbox"/>	<input checked="" type="checkbox"/>	<input checked="" type="checkbox"/>	<input checked="" type="checkbox"/>	<input checked="" type="checkbox"/>	<input checked="" type="checkbox"/>	<input checked="" type="checkbox"/>	<input checked="" type="checkbox"/>	<input checked="" type="checkbox"/>	<input checked="" type="checkbox"/>	20
21	<input checked="" type="checkbox"/>	<input checked="" type="checkbox"/>	<input checked="" type="checkbox"/>	<input checked="" type="checkbox"/>	<input checked="" type="checkbox"/>	<input checked="" type="checkbox"/>	<input checked="" type="checkbox"/>	<input checked="" type="checkbox"/>	<input checked="" type="checkbox"/>	<input checked="" type="checkbox"/>	<input checked="" type="checkbox"/>	<input checked="" type="checkbox"/>	<input checked="" type="checkbox"/>	<input checked="" type="checkbox"/>	<input checked="" type="checkbox"/>	<input checked="" type="checkbox"/>	<input checked="" type="checkbox"/>	<input checked="" type="checkbox"/>	<input checked="" type="checkbox"/>	<input checked="" type="checkbox"/>	<input checked="" type="checkbox"/>	<input checked="" type="checkbox"/>	<input checked="" type="checkbox"/>	<input checked="" type="checkbox"/>	<input checked="" type="checkbox"/>	<input checked="" type="checkbox"/>	<input checked="" type="checkbox"/>	<input checked="" type="checkbox"/>	<input checked="" type="checkbox"/>	21
22	<input checked="" type="checkbox"/>	<input checked="" type="checkbox"/>	<input checked="" type="checkbox"/>	<input checked="" type="checkbox"/>	<input checked="" type="checkbox"/>	<input checked="" type="checkbox"/>	<input checked="" type="checkbox"/>	<input checked="" type="checkbox"/>	<input checked="" type="checkbox"/>	<input checked="" type="checkbox"/>	<input checked="" type="checkbox"/>	<input checked="" type="checkbox"/>	<input checked="" type="checkbox"/>	<input checked="" type="checkbox"/>	<input checked="" type="checkbox"/>	<input checked="" type="checkbox"/>	<input checked="" type="checkbox"/>	<input checked="" type="checkbox"/>	<input checked="" type="checkbox"/>	<input checked="" type="checkbox"/>	<input checked="" type="checkbox"/>	<input checked="" type="checkbox"/>	<input checked="" type="checkbox"/>	<input checked="" type="checkbox"/>	<input checked="" type="checkbox"/>	<input checked="" type="checkbox"/>	<input checked="" type="checkbox"/>	<input checked="" type="checkbox"/>	<input checked="" type="checkbox"/>	22
23	<input checked="" type="checkbox"/>	<input checked="" type="checkbox"/>	<input checked="" type="checkbox"/>	<input checked="" type="checkbox"/>	<input checked="" type="checkbox"/>	<input checked="" type="checkbox"/>	<input checked="" type="checkbox"/>	<input checked="" type="checkbox"/>	<input checked="" type="checkbox"/>	<input checked="" type="checkbox"/>	<input checked="" type="checkbox"/>	<input checked="" type="checkbox"/>	<input checked="" type="checkbox"/>	<input checked="" type="checkbox"/>	<input checked="" type="checkbox"/>	<input checked="" type="checkbox"/>	<input checked="" type="checkbox"/>	<input checked="" type="checkbox"/>	<input checked="" type="checkbox"/>	<input checked="" type="checkbox"/>	<input checked="" type="checkbox"/>	<input checked="" type="checkbox"/>	<input checked="" type="checkbox"/>	<input checked="" type="checkbox"/>	<input checked="" type="checkbox"/>	<input checked="" type="checkbox"/>	<input checked="" type="checkbox"/>	<input checked="" type="checkbox"/>	<input checked="" type="checkbox"/>	23
24	<input checked="" type="checkbox"/>	<input checked="" type="checkbox"/>	<input checked="" type="checkbox"/>	<input checked="" type="checkbox"/>	<input checked="" type="checkbox"/>	<input checked="" type="checkbox"/>	<input checked="" type="checkbox"/>	<input checked="" type="checkbox"/>	<input checked="" type="checkbox"/>	<input checked="" type="checkbox"/>	<input checked="" type="checkbox"/>	<input checked="" type="checkbox"/>	<input checked="" type="checkbox"/>	<input checked="" type="checkbox"/>	<input checked="" type="checkbox"/>	<input checked="" type="checkbox"/>	<input checked="" type="checkbox"/>	<input checked="" type="checkbox"/>	<input checked="" type="checkbox"/>	<input checked="" type="checkbox"/>	<input checked="" type="checkbox"/>	<input checked="" type="checkbox"/>	<input checked="" type="checkbox"/>	<input checked="" type="checkbox"/>	<input checked="" type="checkbox"/>	<input checked="" type="checkbox"/>	<input checked="" type="checkbox"/>	<input checked="" type="checkbox"/>	<input checked="" type="checkbox"/>	24
25	<input checked="" type="checkbox"/>	<input checked="" type="checkbox"/>	<input checked="" type="checkbox"/>	<input checked="" type="checkbox"/>	<input checked="" type="checkbox"/>	<input checked="" type="checkbox"/>	<input checked="" type="checkbox"/>	<input checked="" type="checkbox"/>	<input checked="" type="checkbox"/>	<input checked="" type="checkbox"/>	<input checked="" type="checkbox"/>	<input checked="" type="checkbox"/>	<input checked="" type="checkbox"/>	<input checked="" type="checkbox"/>	<input checked="" type="checkbox"/>	<input checked="" type="checkbox"/>	<input checked="" type="checkbox"/>	<input checked="" type="checkbox"/>	<input checked="" type="checkbox"/>	<input checked="" type="checkbox"/>	<input checked="" type="checkbox"/>	<input checked="" type="checkbox"/>	<input checked="" type="checkbox"/>	<input checked="" type="checkbox"/>	<input checked="" type="checkbox"/>	<input checked="" type="checkbox"/>	<input checked="" type="checkbox"/>	<input checked="" type="checkbox"/>	<input checked="" type="checkbox"/>	25
26	<input checked="" type="checkbox"/>	<input checked="" type="checkbox"/>	<input checked="" type="checkbox"/>	<input checked="" type="checkbox"/>	<input checked="" type="checkbox"/>	<input checked="" type="checkbox"/>	<input checked="" type="checkbox"/>	<input checked="" type="checkbox"/>	<input checked="" type="checkbox"/>	<input checked="" type="checkbox"/>	<input checked="" type="checkbox"/>	<input checked="" type="checkbox"/>	<input checked="" type="checkbox"/>	<input checked="" type="checkbox"/>	<input checked="" type="checkbox"/>	<input checked="" type="checkbox"/>	<input checked="" type="checkbox"/>	<input checked="" type="checkbox"/>	<input checked="" type="checkbox"/>	<input checked="" type="checkbox"/>	<input checked="" type="checkbox"/>	<input checked="" type="checkbox"/>	<input checked="" type="checkbox"/>	<input checked="" type="checkbox"/>	<input checked="" type="checkbox"/>	<input checked="" type="checkbox"/>	<input checked="" type="checkbox"/>	<input checked="" type="checkbox"/>	<input checked="" type="checkbox"/>	26
27	<input checked="" type="checkbox"/>	<input checked="" type="checkbox"/>	<input checked="" type="checkbox"/>	<input checked="" type="checkbox"/>	<input checked="" type="checkbox"/>	<input checked="" type="checkbox"/>	<input checked="" type="checkbox"/>	<input checked="" type="checkbox"/>	<input checked="" type="checkbox"/>	<input checked="" type="checkbox"/>	<input checked="" type="checkbox"/>	<input checked="" type="checkbox"/>	<input checked="" type="checkbox"/>	<input checked="" type="checkbox"/>	<input checked="" type="checkbox"/>	<input checked="" type="checkbox"/>	<input checked="" type="checkbox"/>	<input checked="" type="checkbox"/>	<input checked="" type="checkbox"/>	<input checked="" type="checkbox"/>	<input checked="" type="checkbox"/>	<input checked="" type="checkbox"/>	<input checked="" type="checkbox"/>	<input checked="" type="checkbox"/>	<input checked="" type="checkbox"/>	<input checked="" type="checkbox"/>	<input checked="" type="checkbox"/>	<input checked="" type="checkbox"/>	<input checked="" type="checkbox"/>	27
28	<input checked="" type="checkbox"/>	<input checked="" type="checkbox"/>	<input checked="" type="checkbox"/>	<input checked="" type="checkbox"/>	<input checked="" type="checkbox"/>	<input checked="" type="checkbox"/>	<input checked="" type="checkbox"/>	<input checked="" type="checkbox"/>	<input checked="" type="checkbox"/>	<input checked="" type="checkbox"/>	<input checked="" type="checkbox"/>	<input checked="" type="checkbox"/>	<input checked="" type="checkbox"/>	<input checked="" type="checkbox"/>	<input checked="" type="checkbox"/>	<input checked="" type="checkbox"/>	<input checked="" type="checkbox"/>	<input checked="" type="checkbox"/>	<input checked="" type="checkbox"/>	<input checked="" type="checkbox"/>	<input checked="" type="checkbox"/>	<input checked="" type="checkbox"/>	<input checked="" type="checkbox"/>	<input checked="" type="checkbox"/>	<input checked="" type="checkbox"/>	<input checked="" type="checkbox"/>	<input checked="" type="checkbox"/>	<input checked="" type="checkbox"/>	<input checked="" type="checkbox"/>	28
CPU	<input checked="" type="checkbox"/>	<input checked="" type="checkbox"/>	<input checked="" type="checkbox"/>	<input checked="" type="checkbox"/>	<input checked="" type="checkbox"/>	<input checked="" type="checkbox"/>	<input checked="" type="checkbox"/>	<input checked="" type="checkbox"/>	<input checked="" type="checkbox"/>	<input checked="" type="checkbox"/>	<input checked="" type="checkbox"/>	<input checked="" type="checkbox"/>	<input checked="" type="checkbox"/>	<input checked="" type="checkbox"/>	<input checked="" type="checkbox"/>	<input checked="" type="checkbox"/>	<input checked="" type="checkbox"/>	<input checked="" type="checkbox"/>	<input checked="" type="checkbox"/>	<input checked="" type="checkbox"/>	<input checked="" type="checkbox"/>	<input checked="" type="checkbox"/>	<input checked="" type="checkbox"/>	<input checked="" type="checkbox"/>	<input checked="" type="checkbox"/>	<input checked="" type="checkbox"/>	<input checked="" type="checkbox"/>	<input checked="" type="checkbox"/>	<input checked="" type="checkbox"/>	CPU
	1	2	3	4	5	6	7	8	9	10	11	12	13	14	15	16	17	18	19	20	21	22	23	24	25	26	27	28		

Outgoing

Apply Cancel

Figure 7-8 Port Based VLAN Setup (All Connected)

● Port Based VLAN Setup

Setting Wizard Port isolation ▾ Apply

Incoming

	1	2	3	4	5	6	7	8	9	10	11	12	13	14	15	16	17	18	19	20	21	22	23	24	25	26	27	28	
1	<input checked="" type="checkbox"/>	<input type="checkbox"/>	<input type="checkbox"/>	<input type="checkbox"/>	<input type="checkbox"/>	<input type="checkbox"/>	<input type="checkbox"/>	<input type="checkbox"/>	<input type="checkbox"/>	<input type="checkbox"/>	<input type="checkbox"/>	<input type="checkbox"/>	<input type="checkbox"/>	<input type="checkbox"/>	<input type="checkbox"/>	<input type="checkbox"/>	<input type="checkbox"/>	<input type="checkbox"/>	<input type="checkbox"/>	<input type="checkbox"/>	<input type="checkbox"/>	<input type="checkbox"/>	<input type="checkbox"/>	<input type="checkbox"/>	<input type="checkbox"/>	<input type="checkbox"/>	<input type="checkbox"/>	<input type="checkbox"/>	1
2	<input type="checkbox"/>	<input checked="" type="checkbox"/>	<input type="checkbox"/>	<input type="checkbox"/>	<input type="checkbox"/>	<input type="checkbox"/>	<input type="checkbox"/>	<input type="checkbox"/>	<input type="checkbox"/>	<input type="checkbox"/>	<input type="checkbox"/>	<input type="checkbox"/>	<input type="checkbox"/>	<input type="checkbox"/>	<input type="checkbox"/>	<input type="checkbox"/>	<input type="checkbox"/>	<input type="checkbox"/>	<input type="checkbox"/>	<input type="checkbox"/>	<input type="checkbox"/>	<input type="checkbox"/>	<input type="checkbox"/>	<input type="checkbox"/>	<input type="checkbox"/>	<input type="checkbox"/>	<input type="checkbox"/>	<input type="checkbox"/>	2
3	<input type="checkbox"/>	<input type="checkbox"/>	<input checked="" type="checkbox"/>	<input type="checkbox"/>	<input type="checkbox"/>	<input type="checkbox"/>	<input type="checkbox"/>	<input type="checkbox"/>	<input type="checkbox"/>	<input type="checkbox"/>	<input type="checkbox"/>	<input type="checkbox"/>	<input type="checkbox"/>	<input type="checkbox"/>	<input type="checkbox"/>	<input type="checkbox"/>	<input type="checkbox"/>	<input type="checkbox"/>	<input type="checkbox"/>	<input type="checkbox"/>	<input type="checkbox"/>	<input type="checkbox"/>	<input type="checkbox"/>	<input type="checkbox"/>	<input type="checkbox"/>	<input type="checkbox"/>	<input type="checkbox"/>	<input type="checkbox"/>	3
4	<input type="checkbox"/>	<input type="checkbox"/>	<input type="checkbox"/>	<input checked="" type="checkbox"/>	<input type="checkbox"/>	<input type="checkbox"/>	<input type="checkbox"/>	<input type="checkbox"/>	<input type="checkbox"/>	<input type="checkbox"/>	<input type="checkbox"/>	<input type="checkbox"/>	<input type="checkbox"/>	<input type="checkbox"/>	<input type="checkbox"/>	<input type="checkbox"/>	<input type="checkbox"/>	<input type="checkbox"/>	<input type="checkbox"/>	<input type="checkbox"/>	<input type="checkbox"/>	<input type="checkbox"/>	<input type="checkbox"/>	<input type="checkbox"/>	<input type="checkbox"/>	<input type="checkbox"/>	<input type="checkbox"/>	<input type="checkbox"/>	4
5	<input type="checkbox"/>	<input type="checkbox"/>	<input type="checkbox"/>	<input type="checkbox"/>	<input checked="" type="checkbox"/>	<input type="checkbox"/>	<input type="checkbox"/>	<input type="checkbox"/>	<input type="checkbox"/>	<input type="checkbox"/>	<input type="checkbox"/>	<input type="checkbox"/>	<input type="checkbox"/>	<input type="checkbox"/>	<input type="checkbox"/>	<input type="checkbox"/>	<input type="checkbox"/>	<input type="checkbox"/>	<input type="checkbox"/>	<input type="checkbox"/>	<input type="checkbox"/>	<input type="checkbox"/>	<input type="checkbox"/>	<input type="checkbox"/>	<input type="checkbox"/>	<input type="checkbox"/>	<input type="checkbox"/>	<input type="checkbox"/>	5
6	<input type="checkbox"/>	<input type="checkbox"/>	<input type="checkbox"/>	<input type="checkbox"/>	<input type="checkbox"/>	<input checked="" type="checkbox"/>	<input type="checkbox"/>	<input type="checkbox"/>	<input type="checkbox"/>	<input type="checkbox"/>	<input type="checkbox"/>	<input type="checkbox"/>	<input type="checkbox"/>	<input type="checkbox"/>	<input type="checkbox"/>	<input type="checkbox"/>	<input type="checkbox"/>	<input type="checkbox"/>	<input type="checkbox"/>	<input type="checkbox"/>	<input type="checkbox"/>	<input type="checkbox"/>	<input type="checkbox"/>	<input type="checkbox"/>	<input type="checkbox"/>	<input type="checkbox"/>	<input type="checkbox"/>	<input type="checkbox"/>	6
7	<input type="checkbox"/>	<input type="checkbox"/>	<input type="checkbox"/>	<input type="checkbox"/>	<input type="checkbox"/>	<input type="checkbox"/>	<input checked="" type="checkbox"/>	<input type="checkbox"/>	<input type="checkbox"/>	<input type="checkbox"/>	<input type="checkbox"/>	<input type="checkbox"/>	<input type="checkbox"/>	<input type="checkbox"/>	<input type="checkbox"/>	<input type="checkbox"/>	<input type="checkbox"/>	<input type="checkbox"/>	<input type="checkbox"/>	<input type="checkbox"/>	<input type="checkbox"/>	<input type="checkbox"/>	<input type="checkbox"/>	<input type="checkbox"/>	<input type="checkbox"/>	<input type="checkbox"/>	<input type="checkbox"/>	<input type="checkbox"/>	7
8	<input type="checkbox"/>	<input type="checkbox"/>	<input type="checkbox"/>	<input type="checkbox"/>	<input type="checkbox"/>	<input type="checkbox"/>	<input type="checkbox"/>	<input checked="" type="checkbox"/>	<input type="checkbox"/>	<input type="checkbox"/>	<input type="checkbox"/>	<input type="checkbox"/>	<input type="checkbox"/>	<input type="checkbox"/>	<input type="checkbox"/>	<input type="checkbox"/>	<input type="checkbox"/>	<input type="checkbox"/>	<input type="checkbox"/>	<input type="checkbox"/>	<input type="checkbox"/>	<input type="checkbox"/>	<input type="checkbox"/>	<input type="checkbox"/>	<input type="checkbox"/>	<input type="checkbox"/>	<input type="checkbox"/>	<input type="checkbox"/>	8
9	<input type="checkbox"/>	<input type="checkbox"/>	<input type="checkbox"/>	<input type="checkbox"/>	<input type="checkbox"/>	<input type="checkbox"/>	<input type="checkbox"/>	<input type="checkbox"/>	<input checked="" type="checkbox"/>	<input type="checkbox"/>	<input type="checkbox"/>	<input type="checkbox"/>	<input type="checkbox"/>	<input type="checkbox"/>	<input type="checkbox"/>	<input type="checkbox"/>	<input type="checkbox"/>	<input type="checkbox"/>	<input type="checkbox"/>	<input type="checkbox"/>	<input type="checkbox"/>	<input type="checkbox"/>	<input type="checkbox"/>	<input type="checkbox"/>	<input type="checkbox"/>	<input type="checkbox"/>	<input type="checkbox"/>	<input type="checkbox"/>	9
10	<input type="checkbox"/>	<input type="checkbox"/>	<input type="checkbox"/>	<input type="checkbox"/>	<input type="checkbox"/>	<input type="checkbox"/>	<input type="checkbox"/>	<input type="checkbox"/>	<input type="checkbox"/>	<input checked="" type="checkbox"/>	<input type="checkbox"/>	<input type="checkbox"/>	<input type="checkbox"/>	<input type="checkbox"/>	<input type="checkbox"/>	<input type="checkbox"/>	<input type="checkbox"/>	<input type="checkbox"/>	<input type="checkbox"/>	<input type="checkbox"/>	<input type="checkbox"/>	<input type="checkbox"/>	<input type="checkbox"/>	<input type="checkbox"/>	<input type="checkbox"/>	<input type="checkbox"/>	<input type="checkbox"/>	<input type="checkbox"/>	10
11	<input type="checkbox"/>	<input type="checkbox"/>	<input type="checkbox"/>	<input type="checkbox"/>	<input type="checkbox"/>	<input type="checkbox"/>	<input type="checkbox"/>	<input type="checkbox"/>	<input type="checkbox"/>	<input type="checkbox"/>	<input checked="" type="checkbox"/>	<input type="checkbox"/>	<input type="checkbox"/>	<input type="checkbox"/>	<input type="checkbox"/>	<input type="checkbox"/>	<input type="checkbox"/>	<input type="checkbox"/>	<input type="checkbox"/>	<input type="checkbox"/>	<input type="checkbox"/>	<input type="checkbox"/>	<input type="checkbox"/>	<input type="checkbox"/>	<input type="checkbox"/>	<input type="checkbox"/>	<input type="checkbox"/>	<input type="checkbox"/>	11
12	<input type="checkbox"/>	<input type="checkbox"/>	<input type="checkbox"/>	<input type="checkbox"/>	<input type="checkbox"/>	<input type="checkbox"/>	<input type="checkbox"/>	<input type="checkbox"/>	<input type="checkbox"/>	<input type="checkbox"/>	<input type="checkbox"/>	<input checked="" type="checkbox"/>	<input type="checkbox"/>	<input type="checkbox"/>	<input type="checkbox"/>	<input type="checkbox"/>	<input type="checkbox"/>	<input type="checkbox"/>	<input type="checkbox"/>	<input type="checkbox"/>	<input type="checkbox"/>	<input type="checkbox"/>	<input type="checkbox"/>	<input type="checkbox"/>	<input type="checkbox"/>	<input type="checkbox"/>	<input type="checkbox"/>	<input type="checkbox"/>	12
13	<input type="checkbox"/>	<input type="checkbox"/>	<input type="checkbox"/>	<input type="checkbox"/>	<input type="checkbox"/>	<input type="checkbox"/>	<input type="checkbox"/>	<input type="checkbox"/>	<input type="checkbox"/>	<input type="checkbox"/>	<input type="checkbox"/>	<input type="checkbox"/>	<input checked="" type="checkbox"/>	<input type="checkbox"/>	<input type="checkbox"/>	<input type="checkbox"/>	<input type="checkbox"/>	<input type="checkbox"/>	<input type="checkbox"/>	<input type="checkbox"/>	<input type="checkbox"/>	<input type="checkbox"/>	<input type="checkbox"/>	<input type="checkbox"/>	<input type="checkbox"/>	<input type="checkbox"/>	<input type="checkbox"/>	<input type="checkbox"/>	13
14	<input type="checkbox"/>	<input type="checkbox"/>	<input type="checkbox"/>	<input type="checkbox"/>	<input type="checkbox"/>	<input type="checkbox"/>	<input type="checkbox"/>	<input type="checkbox"/>	<input type="checkbox"/>	<input type="checkbox"/>	<input type="checkbox"/>	<input type="checkbox"/>	<input type="checkbox"/>	<input checked="" type="checkbox"/>	<input type="checkbox"/>	<input type="checkbox"/>	<input type="checkbox"/>	<input type="checkbox"/>	<input type="checkbox"/>	<input type="checkbox"/>	<input type="checkbox"/>	<input type="checkbox"/>	<input type="checkbox"/>	<input type="checkbox"/>	<input type="checkbox"/>	<input type="checkbox"/>	<input type="checkbox"/>	<input type="checkbox"/>	14
15	<input type="checkbox"/>	<input type="checkbox"/>	<input type="checkbox"/>	<input type="checkbox"/>	<input type="checkbox"/>	<input type="checkbox"/>	<input type="checkbox"/>	<input type="checkbox"/>	<input type="checkbox"/>	<input type="checkbox"/>	<input type="checkbox"/>	<input type="checkbox"/>	<input type="checkbox"/>	<input type="checkbox"/>	<input checked="" type="checkbox"/>	<input type="checkbox"/>	<input type="checkbox"/>	<input type="checkbox"/>	<input type="checkbox"/>	<input type="checkbox"/>	<input type="checkbox"/>	<input type="checkbox"/>	<input type="checkbox"/>	<input type="checkbox"/>	<input type="checkbox"/>	<input type="checkbox"/>	<input type="checkbox"/>	<input type="checkbox"/>	15
16	<input type="checkbox"/>	<input type="checkbox"/>	<input type="checkbox"/>	<input type="checkbox"/>	<input type="checkbox"/>	<input type="checkbox"/>	<input type="checkbox"/>	<input type="checkbox"/>	<input type="checkbox"/>	<input type="checkbox"/>	<input type="checkbox"/>	<input type="checkbox"/>	<input type="checkbox"/>	<input type="checkbox"/>	<input type="checkbox"/>	<input checked="" type="checkbox"/>	<input type="checkbox"/>	<input type="checkbox"/>	<input type="checkbox"/>	<input type="checkbox"/>	<input type="checkbox"/>	<input type="checkbox"/>	<input type="checkbox"/>	<input type="checkbox"/>	<input type="checkbox"/>	<input type="checkbox"/>	<input type="checkbox"/>	<input type="checkbox"/>	16
17	<input type="checkbox"/>	<input type="checkbox"/>	<input type="checkbox"/>	<input type="checkbox"/>	<input type="checkbox"/>	<input type="checkbox"/>	<input type="checkbox"/>	<input type="checkbox"/>	<input type="checkbox"/>	<input type="checkbox"/>	<input type="checkbox"/>	<input type="checkbox"/>	<input type="checkbox"/>	<input type="checkbox"/>	<input type="checkbox"/>	<input type="checkbox"/>	<input checked="" type="checkbox"/>	<input type="checkbox"/>	<input type="checkbox"/>	<input type="checkbox"/>	<input type="checkbox"/>	<input type="checkbox"/>	<input type="checkbox"/>	<input type="checkbox"/>	<input type="checkbox"/>	<input type="checkbox"/>	<input type="checkbox"/>	<input type="checkbox"/>	17
18	<input type="checkbox"/>	<input type="checkbox"/>	<input type="checkbox"/>	<input type="checkbox"/>	<input type="checkbox"/>	<input type="checkbox"/>	<input type="checkbox"/>	<input type="checkbox"/>	<input type="checkbox"/>	<input type="checkbox"/>	<input type="checkbox"/>	<input type="checkbox"/>	<input type="checkbox"/>	<input type="checkbox"/>	<input type="checkbox"/>	<input type="checkbox"/>	<input type="checkbox"/>	<input checked="" type="checkbox"/>	<input type="checkbox"/>	<input type="checkbox"/>	<input type="checkbox"/>	<input type="checkbox"/>	<input type="checkbox"/>	<input type="checkbox"/>	<input type="checkbox"/>	<input type="checkbox"/>	<input type="checkbox"/>	<input type="checkbox"/>	18
19	<input type="checkbox"/>	<input type="checkbox"/>	<input type="checkbox"/>	<input type="checkbox"/>	<input type="checkbox"/>	<input type="checkbox"/>	<input type="checkbox"/>	<input type="checkbox"/>	<input type="checkbox"/>	<input type="checkbox"/>	<input type="checkbox"/>	<input type="checkbox"/>	<input type="checkbox"/>	<input type="checkbox"/>	<input type="checkbox"/>	<input type="checkbox"/>	<input type="checkbox"/>	<input type="checkbox"/>	<input checked="" type="checkbox"/>	<input type="checkbox"/>	<input type="checkbox"/>	<input type="checkbox"/>	<input type="checkbox"/>	<input type="checkbox"/>	<input type="checkbox"/>	<input type="checkbox"/>	<input type="checkbox"/>	<input type="checkbox"/>	19
20	<input type="checkbox"/>	<input type="checkbox"/>	<input type="checkbox"/>	<input type="checkbox"/>	<input type="checkbox"/>	<input type="checkbox"/>	<input type="checkbox"/>	<input type="checkbox"/>	<input type="checkbox"/>	<input type="checkbox"/>	<input type="checkbox"/>	<input type="checkbox"/>	<input type="checkbox"/>	<input type="checkbox"/>	<input type="checkbox"/>	<input type="checkbox"/>	<input type="checkbox"/>	<input type="checkbox"/>	<input type="checkbox"/>	<input checked="" type="checkbox"/>	<input type="checkbox"/>	<input type="checkbox"/>	<input type="checkbox"/>	<input type="checkbox"/>	<input type="checkbox"/>	<input type="checkbox"/>	<input type="checkbox"/>	<input type="checkbox"/>	20
21	<input type="checkbox"/>	<input type="checkbox"/>	<input type="checkbox"/>	<input type="checkbox"/>	<input type="checkbox"/>	<input type="checkbox"/>	<input type="checkbox"/>	<input type="checkbox"/>	<input type="checkbox"/>	<input type="checkbox"/>	<input type="checkbox"/>	<input type="checkbox"/>	<input type="checkbox"/>	<input type="checkbox"/>	<input type="checkbox"/>	<input type="checkbox"/>	<input type="checkbox"/>	<input type="checkbox"/>	<input type="checkbox"/>	<input type="checkbox"/>	<input checked="" type="checkbox"/>	<input type="checkbox"/>	<input type="checkbox"/>	<input type="checkbox"/>	<input type="checkbox"/>	<input type="checkbox"/>	<input type="checkbox"/>	<input type="checkbox"/>	21
22	<input type="checkbox"/>	<input type="checkbox"/>	<input type="checkbox"/>	<input type="checkbox"/>	<input type="checkbox"/>	<input type="checkbox"/>	<input type="checkbox"/>	<input type="checkbox"/>	<input type="checkbox"/>	<input type="checkbox"/>	<input type="checkbox"/>	<input type="checkbox"/>	<input type="checkbox"/>	<input type="checkbox"/>	<input type="checkbox"/>	<input type="checkbox"/>	<input type="checkbox"/>	<input type="checkbox"/>	<input type="checkbox"/>	<input type="checkbox"/>	<input type="checkbox"/>	<input checked="" type="checkbox"/>	<input type="checkbox"/>	<input type="checkbox"/>	<input type="checkbox"/>	<input type="checkbox"/>	<input type="checkbox"/>	<input type="checkbox"/>	22
23	<input type="checkbox"/>	<input type="checkbox"/>	<input type="checkbox"/>	<input type="checkbox"/>	<input type="checkbox"/>	<input type="checkbox"/>	<input type="checkbox"/>	<input type="checkbox"/>	<input type="checkbox"/>	<input type="checkbox"/>	<input type="checkbox"/>	<input type="checkbox"/>	<input type="checkbox"/>	<input type="checkbox"/>	<input type="checkbox"/>	<input type="checkbox"/>	<input type="checkbox"/>	<input type="checkbox"/>	<input type="checkbox"/>	<input type="checkbox"/>	<input type="checkbox"/>	<input type="checkbox"/>	<input checked="" type="checkbox"/>	<input type="checkbox"/>	<input type="checkbox"/>	<input type="checkbox"/>	<input type="checkbox"/>	<input type="checkbox"/>	23
24	<input type="checkbox"/>	<input type="checkbox"/>	<input type="checkbox"/>	<input type="checkbox"/>	<input type="checkbox"/>	<input type="checkbox"/>	<input type="checkbox"/>	<input type="checkbox"/>	<input type="checkbox"/>	<input type="checkbox"/>	<input type="checkbox"/>	<input type="checkbox"/>	<input type="checkbox"/>	<input type="checkbox"/>	<input type="checkbox"/>	<input type="checkbox"/>	<input type="checkbox"/>	<input type="checkbox"/>	<input type="checkbox"/>	<input type="checkbox"/>	<input type="checkbox"/>	<input type="checkbox"/>	<input type="checkbox"/>	<input checked="" type="checkbox"/>	<input type="checkbox"/>	<input type="checkbox"/>	<input type="checkbox"/>	<input type="checkbox"/>	24
25	<input type="checkbox"/>	<input type="checkbox"/>	<input type="checkbox"/>	<input type="checkbox"/>	<input type="checkbox"/>	<input type="checkbox"/>	<input type="checkbox"/>	<input type="checkbox"/>	<input type="checkbox"/>	<input type="checkbox"/>	<input type="checkbox"/>	<input type="checkbox"/>	<input type="checkbox"/>	<input type="checkbox"/>	<input type="checkbox"/>	<input type="checkbox"/>	<input type="checkbox"/>	<input type="checkbox"/>	<input type="checkbox"/>	<input type="checkbox"/>	<input type="checkbox"/>	<input type="checkbox"/>	<input type="checkbox"/>	<input type="checkbox"/>	<input checked="" type="checkbox"/>	<input type="checkbox"/>	<input type="checkbox"/>	<input type="checkbox"/>	25
26	<input type="checkbox"/>	<input type="checkbox"/>	<input type="checkbox"/>	<input type="checkbox"/>	<input type="checkbox"/>	<input type="checkbox"/>	<input type="checkbox"/>	<input type="checkbox"/>	<input type="checkbox"/>	<input type="checkbox"/>	<input type="checkbox"/>	<input type="checkbox"/>	<input type="checkbox"/>	<input type="checkbox"/>	<input type="checkbox"/>	<input type="checkbox"/>	<input type="checkbox"/>	<input type="checkbox"/>	<input type="checkbox"/>	<input type="checkbox"/>	<input type="checkbox"/>	<input type="checkbox"/>	<input type="checkbox"/>	<input type="checkbox"/>	<input type="checkbox"/>	<input checked="" type="checkbox"/>	<input type="checkbox"/>	<input type="checkbox"/>	26
27	<input type="checkbox"/>	<input type="checkbox"/>	<input type="checkbox"/>	<input type="checkbox"/>	<input type="checkbox"/>	<input type="checkbox"/>	<input type="checkbox"/>	<input type="checkbox"/>	<input type="checkbox"/>	<input type="checkbox"/>	<input type="checkbox"/>	<input type="checkbox"/>	<input type="checkbox"/>	<input type="checkbox"/>	<input type="checkbox"/>	<input type="checkbox"/>	<input type="checkbox"/>	<input type="checkbox"/>	<input type="checkbox"/>	<input type="checkbox"/>	<input type="checkbox"/>	<input type="checkbox"/>	<input type="checkbox"/>	<input type="checkbox"/>	<input type="checkbox"/>	<input type="checkbox"/>	<input checked="" type="checkbox"/>	<input type="checkbox"/>	27
28	<input type="checkbox"/>	<input type="checkbox"/>	<input type="checkbox"/>	<input type="checkbox"/>	<input type="checkbox"/>	<input type="checkbox"/>	<input type="checkbox"/>	<input type="checkbox"/>	<input type="checkbox"/>	<input type="checkbox"/>	<input type="checkbox"/>	<input type="checkbox"/>	<input type="checkbox"/>	<input type="checkbox"/>	<input type="checkbox"/>	<input type="checkbox"/>	<input type="checkbox"/>	<input type="checkbox"/>	<input type="checkbox"/>	<input type="checkbox"/>	<input type="checkbox"/>	<input type="checkbox"/>	<input type="checkbox"/>	<input type="checkbox"/>	<input type="checkbox"/>	<input type="checkbox"/>	<input checked="" type="checkbox"/>	<input type="checkbox"/>	28
CPU	<input checked="" type="checkbox"/>	<input checked="" type="checkbox"/>	<input checked="" type="checkbox"/>	<input checked="" type="checkbox"/>	<input checked="" type="checkbox"/>	<input checked="" type="checkbox"/>	<input checked="" type="checkbox"/>	<input checked="" type="checkbox"/>	<input checked="" type="checkbox"/>	<input checked="" type="checkbox"/>	<input checked="" type="checkbox"/>	<input checked="" type="checkbox"/>	<input checked="" type="checkbox"/>	<input checked="" type="checkbox"/>	<input checked="" type="checkbox"/>	<input checked="" type="checkbox"/>	<input checked="" type="checkbox"/>	<input checked="" type="checkbox"/>	<input checked="" type="checkbox"/>	<input checked="" type="checkbox"/>	<input checked="" type="checkbox"/>	<input checked="" type="checkbox"/>	<input checked="" type="checkbox"/>	<input checked="" type="checkbox"/>	<input checked="" type="checkbox"/>	<input checked="" type="checkbox"/>	<input checked="" type="checkbox"/>	<input checked="" type="checkbox"/>	CPU

Outgoing

Apply Cancel

Figure 7-9 Port Based VLAN Setup (Port isolation)

The following table describes the labels in this screen.

Table 7-6 Port Based VLAN Setup

LABEL	DESCRIPTION
Setting Wizard	<p>Choose from All connected or Port isolation.</p> <p>All connected means all ports can communicate with each other, that is, there are no virtual LANs. All incoming and outgoing ports are selected (<i>Figure 7-8</i>). This option is the most flexible but also the least secure.</p> <p>Port isolation means that each port can only communicate with the CPU management port and cannot communicate with each other. All incoming ports are selected while only the CPU outgoing port is selected (<i>Figure 7-9</i>). This option is the most limiting but also the most secure.</p> <p>After you make your selection, click Apply (top right of screen) to display the screens as mentioned above. You can still customize these settings by adding/deleting incoming or outgoing ports, but you must also click Apply at the bottom of the screen.</p>
Incoming	<p>These are the ingress ports; an ingress port is an incoming port, that is, a port through which a data packet enters. If you wish to allow two subscriber ports to talk to each other, you must define the ingress port for both ports. The numbers in the top row denote the incoming port for the corresponding port listed on the left (its outgoing port). CPU refers to the switch management port. By default it forms a VLAN with all Ethernet ports. If it does not form a VLAN with a particular port then the switch cannot be managed from that port.</p>
Outgoing	<p>These are the egress ports; an egress port is an outgoing port, that is, a port through which a data packet leaves. If you wish to allow two subscriber ports to talk to each other, you must define the egress port for both ports. CPU refers to the switch management port. By default it forms a VLAN with all Ethernet ports. If it does not form a VLAN with a particular port then the switch cannot be managed from that port.</p>
Apply	Click Apply to save the changes, including the “wizard settings”.
Cancel	Click Cancel to start configuring the screen again.

Chapter 8

Static MAC Forward Setup

Use these screens to configure static MAC address forwarding.

8.1 Introduction to Static MAC Forward Setup

A static MAC address entry is an address that has been manually entered in the MAC address learning table. Static MAC addresses do not age out. When you set up static MAC address rules, you are setting static MAC addresses for a port. Devices that match static MAC address rules on a port can *only* receive traffic on that port and cannot receive traffic on other ports. This may reduce unicast flooding.

8.2 Configuring Static MAC Forwarding

Click **Static MAC Forwarding** to display the configuration screen as shown.

Figure 8-1 Static MAC Forwarding

The following table describes the labels in this screen.

Table 8-1 Static MAC Forwarding

LABEL	DESCRIPTION
Active	Select this check box to activate your rule. You may temporarily deactivate a rule without deleting it by clearing this check box.
Name	Enter a descriptive name for identification purposes for this static MAC address forwarding rule.

Table 8-1 Static MAC Forwarding

LABEL	DESCRIPTION
MAC Address	Enter the MAC address in valid MAC address format, that is, six hexadecimal character pairs. Static MAC addresses do not age out.
VID	Enter the VLAN identification number.
Port	Select a port where the MAC address entered in the previous field will be automatically forwarded.
Add	Click Add to save the new rule to the switch. It then displays in the summary table at the bottom of the screen.
Cancel	Click Cancel to reset the fields to your previous configuration.
Clear	Click Clear to clear the fields to the factory defaults.

8.3 Viewing and Editing Static MAC Forwarding Rules

To view a summary of the rule configuration, scroll down to the summary table at the bottom of the **Static MAC Forwarding** screen.

To change the settings of a rule, click a number in the **Index** field.

Index	Active	Name	MAC Address	Port	Delete
1	Yes	test	0a:b2:a0:81:f3:7e / 1	1	<input type="checkbox"/>

Figure 8-2 Static MAC Forwarding: Summary Table

The following table describes the labels in this screen.

Table 8-2 Static MAC Forwarding: Summary Table

LABEL	DESCRIPTION
Index	Click an index number to modify a static MAC address rule for a port.
Active	This field displays whether this static MAC address forwarding rule is active (Yes) or not (No). You may temporarily deactivate a rule without deleting it.
Name	This field displays the descriptive name for identification purposes for this static MAC address-forwarding rule.
MAC Address	This field displays the MAC address that will be forwarded and the VLAN identification number to which the MAC address belongs.
Port	This field displays the port where the MAC address shown in the next field will be forwarded.
Delete	Check the rule(s) that you want to remove in the Delete column, then click the Delete button.
Cancel	Click Cancel to clear the selected checkboxes in the Delete column.

Chapter 9

Filtering

This chapter discusses static IP and MAC address port filtering.

9.1 Introduction to Filtering

Filtering means sifting traffic going through the switch based on the source and/or destination MAC addresses and VLAN group (ID).

9.2 Configuring a Filtering Rule

Click **Filtering** to display the screen as shown next.

Figure 9-1 Filtering

The following table describes the related labels in this screen.

Table 9-1 Filtering

LABEL	DESCRIPTION
Active	Make sure to select this check box to activate your rule. You may temporarily deactivate a rule without deleting it by deselecting this check box.
Name	Type a descriptive name for this filter rule. This is for identification purpose only.

Table 9-1 Filtering

LABEL	DESCRIPTION
Action	Select Discard source to drop frame from the source MAC address (specified in the MAC field). The switch can still send frames to the MAC address. Select Discard destination to drop frames to the destination MAC address (specified in the MAC address). The switch can still receive frames originating from the MAC address. Select Discard source and Discard destination to block traffic to/from the MAC address specified in the MAC field.
MAC	Type a MAC address in valid MAC address format, that is, six hexadecimal character pairs to apply the filter rule to the specified MAC address and VLAN group.
VID	Type the VLAN group identification number.
Add	Click Add to save the new rule to the switch. It then displays in the summary table at the bottom of the screen.
Cancel	Click Cancel to reset the fields to your previous configuration.
Clear	Click Clear to clear the fields to the factory defaults.

9.3 Viewing and Editing Filter Rules

To view a summary of the rule configuration, scroll down to the summary table at the bottom of the **Filtering** screen.

To change the settings of a rule, click a number in the **Index** field.

Index	Active	Name	MAC Address	Action	Delete
1	Yes	test	00:a0:c5:00:01:27/1	Discard both	<input type="checkbox"/>

Figure 9-2 Filtering: Summary Table

The following table describes the labels in the summary table.

Table 9-2 Filtering: Summary Table

LABEL	DESCRIPTION
Index	This field displays the index number of the rule. Click an index number to edit the rule.
Active	This field displays Yes when the rule is activated and No when is it deactivated.
Name	This field displays the descriptive name for this rule. This is for identification purpose only.
MAC Address	This field displays the MAC address with the VLAN identification number to which the MAC address belongs or a combination of the two.
Action	This field displays the filtering action (Discard both , Discard source or Discard dest.).

Table 9-2 Filtering: Summary Table

LABEL	DESCRIPTION
Delete	Check the rule(s) that you want to remove in the Delete column and then click the Delete button.
Cancel	Click Cancel to clear the selected checkboxes in the Delete column.

Chapter 10 Spanning Tree Protocol

This chapter introduces the Spanning Tree Protocol (STP).

10.1 Introduction to Spanning Tree Protocol (STP)

STP detects and breaks network loops and provides backup links between switches, bridges or routers. It allows a switch to interact with other STP-compliant switches in your network to ensure that only one route exists between any two stations on the network.

10.1.1 STP Terminology

The root bridge is the base of the spanning tree; it is the bridge with the lowest identifier value (MAC address).

Path cost is the cost of transmitting a frame onto a LAN through that port. It is assigned according to the speed of the link to which a port is attached. The slower the media, the higher the cost - see the next table.

Table 10-1 STP Path Costs

	LINK SPEED	RECOMMENDED VALUE	RECOMMENDED RANGE	ALLOWED RANGE
Path Cost	4Mbps	250	100 to 1000	1 to 65535
Path Cost	10Mbps	100	50 to 600	1 to 65535
Path Cost	16Mbps	62	40 to 400	1 to 65535
Path Cost	100Mbps	19	10 to 60	1 to 65535
Path Cost	1Gbps	4	3 to 10	1 to 65535
Path Cost	10Gbps	2	1 to 5	1 to 65535

On each bridge, the root port is the port through which this bridge communicates with the root. It is the port on this switch with the lowest path cost to the root (the root path cost). If there is no root port, then this switch has been accepted as the root bridge of the spanning tree network.

For each LAN segment, a designated bridge is selected. This bridge has the lowest cost to the root among the bridges connected to the LAN.

10.1.2 How STP Works

After a bridge determines the lowest cost-spanning tree with STP, it enables the root port and the ports that are the designated ports for connected LANs, and disables all other ports that participate in STP. Network packets are therefore only forwarded between enabled ports, eliminating any possible network loops.

STP-aware switches exchange Bridge Protocol Data Units (BPDUs) periodically. When the bridged LAN topology changes, a new spanning tree is constructed.

Once a stable network topology has been established, all bridges listen for Hello BPDUs (Bridge Protocol Data Units) transmitted from the root bridge. If a bridge does not get a Hello BPDU after a predefined interval (Max Age), the bridge assumes that the link to the root bridge is down. This bridge then initiates negotiations with other bridges to reconfigure the network to re-establish a valid network topology.

10.1.3 STP Port States

STP assigns five port states (see next table) to eliminate packet looping. A bridge port is not allowed to go directly from blocking state to forwarding state so as to eliminate transient loops.

Table 10-2 STP Port States

PORT STATE	DESCRIPTION
Disabled	STP is disabled (default).
Blocking	Only configuration and management BPDUs are received and processed.
Listening	All BPDUs are received and processed.
Learning	All BPDUs are received and processed. Information frames are submitted to the learning process but not forwarded.
Forwarding	All BPDUs are received and processed. All information frames are received and forwarded.

10.2 STP Status

Click **Advanced Application** and then **Spanning Tree Protocol** in the navigation panel to display the STP status as shown in the screen next.

Spanning Tree Protocol Status [Configuration](#)

Spanning Tree Protocol : Down

Bridge	Root	Our Bridge
Bridge ID	0000-000000000000	0000-000000000000
Hello Time (second)	0	0
Max Age (second)	0	0
Forwarding Delay (second)	0	0
Cost to Bridge	0	
Port ID	0X0000	
Topology Changed Times		0
Time Since Last Change		0:00:00

Polling Interval

Figure 10-1 Spanning Tree Protocol: Status

The following table describes the labels in this screen.

Table 10-3 Spanning Tree Protocol: Status

LABEL	DESCRIPTION
Spanning Tree Protocol	This field displays Running if STP is activated. Otherwise, it displays Down .
Bridge	Root refers to the base of the spanning tree (the root bridge). Our Bridge is this switch. This switch may also be the root bridge.
Bridge ID	This is the unique identifier for this bridge, consisting of bridge priority plus MAC address. This ID is the same for Root and Our Bridge if the switch is the root switch.
Hello Time (second)	This is the time interval (in seconds) at which the root switch transmits a configuration message. The root bridge determines Hello Time , Max Age and Forwarding Delay
Max Age (second)	This is the maximum time (in seconds) a switch can wait without receiving a configuration message before attempting to reconfigure.

Table 10-3 Spanning Tree Protocol: Status

LABEL	DESCRIPTION
Forwarding Delay (second)	This is the time (in seconds) the root switch will wait before changing states (that is, listening to learning to forwarding).
Cost to Bridge	This is the path cost from the root port on this switch to the root switch.
Port ID	This is the priority and number of the port on the switch through which this switch must communicate with the root of the Spanning Tree.
Topology Changed Times	This is the number of times the spanning tree has been reconfigured.
Time Since Last Change	This is the time since the spanning tree was last reconfigured.
Poll Interval(s)	The text box displays how often (in seconds) this screen refreshes. You may change the refresh interval by typing a new number in the text box and then clicking Set Interval .
Stop	Click Stop to halt STP statistic polling.

10.2.1 Configuring STP

To configure STP, click the **Configuration** link in the **Spanning Tree Protocol** screen as shown next.

Spanning Tree Protocol
Status

Active

Bridge Priority

Hello Time Seconds

Max Age Seconds

Forwarding Delay Seconds

Port	Active	Priority	Path Cost
1	<input type="checkbox"/>	<input type="text" value="128"/>	<input type="text" value="19"/>
2	<input type="checkbox"/>	<input type="text" value="128"/>	<input type="text" value="19"/>
3	<input type="checkbox"/>	<input type="text" value="128"/>	<input type="text" value="19"/>
4	<input type="checkbox"/>	<input type="text" value="128"/>	<input type="text" value="19"/>
5	<input type="checkbox"/>	<input type="text" value="128"/>	<input type="text" value="19"/>
6	<input type="checkbox"/>	<input type="text" value="128"/>	<input type="text" value="19"/>
7	<input type="checkbox"/>	<input type="text" value="128"/>	<input type="text" value="19"/>
8	<input type="checkbox"/>	<input type="text" value="128"/>	<input type="text" value="19"/>
9	<input type="checkbox"/>	<input type="text" value="128"/>	<input type="text" value="19"/>
10	<input type="checkbox"/>	<input type="text" value="128"/>	<input type="text" value="19"/>
11	<input type="checkbox"/>	<input type="text" value="128"/>	<input type="text" value="19"/>
12	<input type="checkbox"/>	<input type="text" value="128"/>	<input type="text" value="19"/>
13	<input type="checkbox"/>	<input type="text" value="128"/>	<input type="text" value="19"/>
14	<input type="checkbox"/>	<input type="text" value="128"/>	<input type="text" value="19"/>
15	<input type="checkbox"/>	<input type="text" value="128"/>	<input type="text" value="19"/>
16	<input type="checkbox"/>	<input type="text" value="128"/>	<input type="text" value="19"/>
17	<input type="checkbox"/>	<input type="text" value="128"/>	<input type="text" value="19"/>
18	<input type="checkbox"/>	<input type="text" value="128"/>	<input type="text" value="19"/>
19	<input type="checkbox"/>	<input type="text" value="128"/>	<input type="text" value="19"/>
20	<input type="checkbox"/>	<input type="text" value="128"/>	<input type="text" value="19"/>
21	<input type="checkbox"/>	<input type="text" value="128"/>	<input type="text" value="19"/>
22	<input type="checkbox"/>	<input type="text" value="128"/>	<input type="text" value="19"/>
23	<input type="checkbox"/>	<input type="text" value="128"/>	<input type="text" value="19"/>
24	<input type="checkbox"/>	<input type="text" value="128"/>	<input type="text" value="19"/>
25	<input type="checkbox"/>	<input type="text" value="128"/>	<input type="text" value="4"/>
26	<input type="checkbox"/>	<input type="text" value="128"/>	<input type="text" value="4"/>
27	<input type="checkbox"/>	<input type="text" value="128"/>	<input type="text" value="4"/>
28	<input type="checkbox"/>	<input type="text" value="128"/>	<input type="text" value="4"/>

Figure 10-2 Spanning Tree Protocol: Configuring

The following table describes the labels in this screen.

Table 10-4 Spanning Tree Protocol: Configuring

LABEL	DESCRIPTION
Active	Select this check box to activate STP.
Bridge Priority	<p>Bridge priority is used in determining the root switch, root port and designated port. The switch with the highest priority (lowest numeric value) becomes the STP root switch. If all switches have the same priority, the switch with the lowest MAC address will then become the root switch. The allowed range is 0 to 65535.</p> <p>The lower the numeric value you assign, the higher the priority for this bridge.</p> <p>Bridge Priority determines the root bridge, which in turn determines Hello Time, Max Age and Forwarding Delay.</p>
Hello Time	This is the time interval in seconds between BPDU (Bridge Protocol Data Units) configuration message generations by the root switch. The allowed range is 1 to 10 seconds.
Max Age	This is the maximum time (in seconds) a switch can wait without receiving a BPDU before attempting to reconfigure. All switch ports (except for designated ports) should receive BPDUs at regular intervals. Any port that ages out STP information (provided in the last BPDU) becomes the designated port for the attached LAN. If it is a root port, a new root port is selected from among the switch ports attached to the network. The allowed range is 6 to 40 seconds.
Forwarding Delay	<p>This is the maximum time (in seconds) a switch will wait before changing states. This delay is required because every switch must receive information about topology changes before it starts to forward frames. In addition, each port needs time to listen for conflicting information that would make it return to a blocking state; otherwise, temporary data loops might result. The allowed range is 4 to 30 seconds.</p> <p>As a general rule:</p>
	$2 * (\text{Forward Delay} - 1) \geq \text{Max Age} \geq 2 * (\text{Hello Time} + 1)$
Port	This field displays the port number.
Active	Select this check box to activate STP on this port.
Priority	<p>Configure the priority for each port here.</p> <p>Priority decides which port should be disabled when more than one port forms a loop in a switch. Ports with a higher priority numeric value are disabled first. The allowed range is between 0 and 255 and default value is 128.</p>
Path Cost	Path cost is the cost of transmitting a frame on to a LAN through that port. It is assigned according to the speed of the bridge. The slower the media, the higher the cost - see <i>Table 10-1</i> for more information.
Apply	Click Apply to save your changes back to the switch.
Cancel	Click Cancel to begin configuring this screen afresh.

Chapter 11

Bandwidth Control

This chapter shows you how you can set the maximum bandwidth allowed for traffic flows on a port using the Bandwidth Control setup screens.

11.1 Introduction to Bandwidth Control

Bandwidth control means defining a maximum allowable bandwidth for incoming and/or out-going traffic flows on a port. Click **Advanced Application** and then **Bandwidth Control** in the navigation panel to bring up the screen as shown next.

Port	Active	Ingress Rate	Egress Rate
1	<input type="checkbox"/>	1 Mbps	1 Mbps
2	<input type="checkbox"/>	1 Mbps	1 Mbps
3	<input type="checkbox"/>	1 Mbps	1 Mbps
4	<input type="checkbox"/>	1 Mbps	1 Mbps
5	<input type="checkbox"/>	1 Mbps	1 Mbps
6	<input type="checkbox"/>	1 Mbps	1 Mbps
7	<input type="checkbox"/>	1 Mbps	1 Mbps
8	<input type="checkbox"/>	1 Mbps	1 Mbps
9	<input type="checkbox"/>	1 Mbps	1 Mbps
10	<input type="checkbox"/>	1 Mbps	1 Mbps
11	<input type="checkbox"/>	1 Mbps	1 Mbps
12	<input type="checkbox"/>	1 Mbps	1 Mbps
13	<input type="checkbox"/>	1 Mbps	1 Mbps
14	<input type="checkbox"/>	1 Mbps	1 Mbps
15	<input type="checkbox"/>	1 Mbps	1 Mbps
16	<input type="checkbox"/>	1 Mbps	1 Mbps
17	<input type="checkbox"/>	1 Mbps	1 Mbps
18	<input type="checkbox"/>	1 Mbps	1 Mbps
19	<input type="checkbox"/>	1 Mbps	1 Mbps
20	<input type="checkbox"/>	1 Mbps	1 Mbps
21	<input type="checkbox"/>	1 Mbps	1 Mbps
22	<input type="checkbox"/>	1 Mbps	1 Mbps
23	<input type="checkbox"/>	1 Mbps	1 Mbps
24	<input type="checkbox"/>	1 Mbps	1 Mbps
25	<input type="checkbox"/>	1 Mbps	1 Mbps
26	<input type="checkbox"/>	1 Mbps	1 Mbps
27	<input type="checkbox"/>	1 Mbps	1 Mbps
28	<input type="checkbox"/>	1 Mbps	1 Mbps

Apply Cancel

Figure 11-1 Bandwidth Control

The following table describes the labels in this screen.

Table 11-1 Bandwidth Control

LABEL	DESCRIPTION
Active	Select this check box to enable bandwidth control.
Port	This field displays the port number.
Active	Make sure to select this check box to activate your rule. You may temporarily deactivate a rule without deleting it by clearing this check box.
Ingress Rate	Type the maximum bandwidth allowed in megabits per second (Mbps) for traffic coming into this port.
Egress Rate	Type the maximum bandwidth allowed in megabits per second (Mbps) for traffic going out of this port.
Apply	Click Apply to save your changes back to the switch.
Cancel	Click Cancel to reset the fields to your previous configuration.

Part V

Advanced Application 2

This part shows you how to configure the Broadcast Storm Control, Mirroring, Link Aggregation, Port Authentication, Port Security, Access Control, Queuing Method, Classifier, Policy Rule and VLAN Stacking Advanced Application screens.

Chapter 12

Broadcast Storm Control

12.1 Introducing Broadcast Storm Control

Broadcast storm control limits the number of broadcast, multicast and destination lookup failure (DLF) packets the switch receives per second on the ports. When the maximum number of allowable broadcast, multicast and/or DLF packets is reached per second, the subsequent packets are discarded. Enable this feature to reduce broadcast, multicast and/or DLF packets in your network. You can specify limits for each packet type on each port.

12.2 Configuring Broadcast Storm Control

Click **Advanced Application, Broadcast Storm Control** in the navigation panel to display the screen as shown next.

Figure 12-1 Broadcast Storm Control

The following table describes the labels in this screen.

Table 12-1 Broadcast Storm Control

LABEL	DESCRIPTION
Active	Select this check box to enable broadcast storm control on the switch.

Table 12-1 Broadcast Storm Control

LABEL	DESCRIPTION
Port	This field displays a port number.
Broadcast (pkt/s)	Select this option and specify how many broadcast packets the port receives per second.
Multicast (pkt/s)	Select this option and specify how many multicast packets the port receives per second.
DLF (pkt/s)	Select this option and specify how many destination lookup failure (DLF) packets the port receives per second.
Apply	Click Apply to save your changes back to the switch.
Cancel	Click Cancel to begin configuring this screen afresh.

Chapter 13

Mirroring

This chapter discusses the Mirror setup screens.

13.1 Introduction to Port Mirroring

Port mirroring allows you to copy traffic going from one or all ports to another or all ports in order that you can examine the traffic from the mirror port (the port you copy the traffic to) without interference.

13.2 Port Mirroring Configuration

Click **Advanced Application, Mirroring** in the navigation panel to display the **Mirroring** screen.

You must first select a monitor port. A monitor port is a port that copies the traffic of another port. After you select a monitor port, configure a mirroring rule in the related fields.

● Mirroring

Active

Monitor Port Port 1 ▼

Port	Mirrored	Direction
1	<input type="checkbox"/>	Ingress ▼
2	<input type="checkbox"/>	Ingress ▼
3	<input type="checkbox"/>	Ingress ▼
4	<input type="checkbox"/>	Ingress ▼
5	<input type="checkbox"/>	Ingress ▼
6	<input type="checkbox"/>	Ingress ▼
7	<input type="checkbox"/>	Ingress ▼
8	<input type="checkbox"/>	Ingress ▼
9	<input type="checkbox"/>	Ingress ▼
10	<input type="checkbox"/>	Ingress ▼
11	<input type="checkbox"/>	Ingress ▼
12	<input type="checkbox"/>	Ingress ▼
13	<input type="checkbox"/>	Ingress ▼
14	<input type="checkbox"/>	Ingress ▼
15	<input type="checkbox"/>	Ingress ▼
16	<input type="checkbox"/>	Ingress ▼
17	<input type="checkbox"/>	Ingress ▼
18	<input type="checkbox"/>	Ingress ▼
19	<input type="checkbox"/>	Ingress ▼
20	<input type="checkbox"/>	Ingress ▼
21	<input type="checkbox"/>	Ingress ▼
22	<input type="checkbox"/>	Ingress ▼
23	<input type="checkbox"/>	Ingress ▼
24	<input type="checkbox"/>	Ingress ▼
25	<input type="checkbox"/>	Ingress ▼
26	<input type="checkbox"/>	Ingress ▼
27	<input type="checkbox"/>	Ingress ▼
28	<input type="checkbox"/>	Ingress ▼

Apply
Cancel

Figure 13-1 Mirroring

The following table describes the related labels in this screen.

Table 13-1 Mirroring

LABEL	DESCRIPTION
Active	Clear this check box to deactivate port mirroring on the switch.
Monitor Port	The monitor port is the port you copy the traffic to in order to examine it in more detail without interfering with the traffic flow on the original port(s). Select this port from this drop-down list box.
Port	This field displays the port number.
Mirrored	Select this option to mirror the traffic on a port.
Direction	Specify the direction of the traffic to mirror. Choices are Egress (outgoing), Ingress (incoming) and Both .
Apply	Click Apply to save the settings.
Cancel	Click Cancel to reset the fields.

Chapter 14

Link Aggregation

This chapter shows you how to logically aggregate physical links to form one logical, higher-bandwidth link.

14.1 Introduction to Link Aggregation

Link aggregation (trunking) is the grouping of physical ports into one logical higher-capacity link. You may want to trunk ports if for example, it is cheaper to use multiple lower-speed links than to under-utilize a high-speed, but more costly, single-port link.

However, the more ports you aggregate then the fewer available ports you have. A link aggregation group is one logical link containing multiple ports.

The first port must be physically connected when forming a trunk group.

14.1.1 Dynamic Link Aggregation

The ES-3124 adheres to the 802.3ad standard for static and dynamic (LACP) port trunking.

The ES-3124 supports the link aggregation IEEE802.3ad standard. This standard describes the Link Aggregate Control Protocol (LACP), which is a protocol that dynamically creates and manages trunk groups.

When you enable LACP link aggregation on a port, the port can automatically negotiate with the ports at the remote end of a link to establish trunk groups. LACP also allows port redundancy, that is, if an operational port fails, then one of the “standby” ports become operational without user intervention

Please note that:

- You must connect all ports point-to-point to the same Ethernet switch and configure the ports for LACP trunking.
- LACP only works on full-duplex links.
- All ports in the same trunk group must have the same media type, speed, duplex mode and flow control settings.

Configure trunk groups or LACP before you connect the Ethernet switch to avoid causing network topology loops.

14.1.2 Link Aggregation ID

LACP aggregation ID consists of the following information:

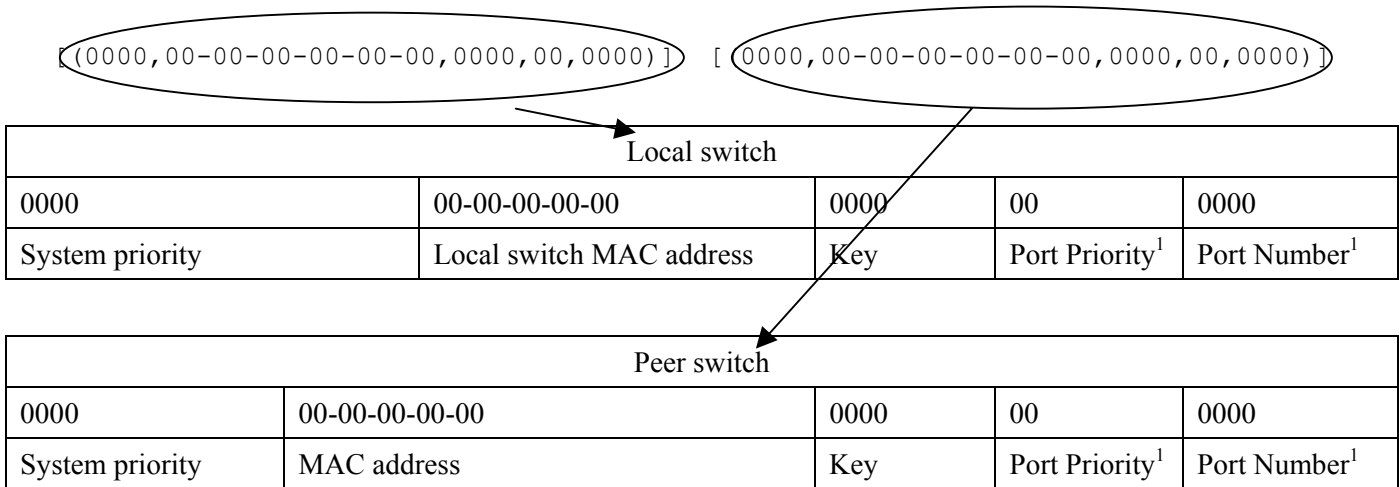

Figure 14-1 Aggregation ID

14.2 Link Aggregation Protocol Status

Click **Link Aggregation** in the navigation panel to display the **Link Aggregation Protocol Status** screen.

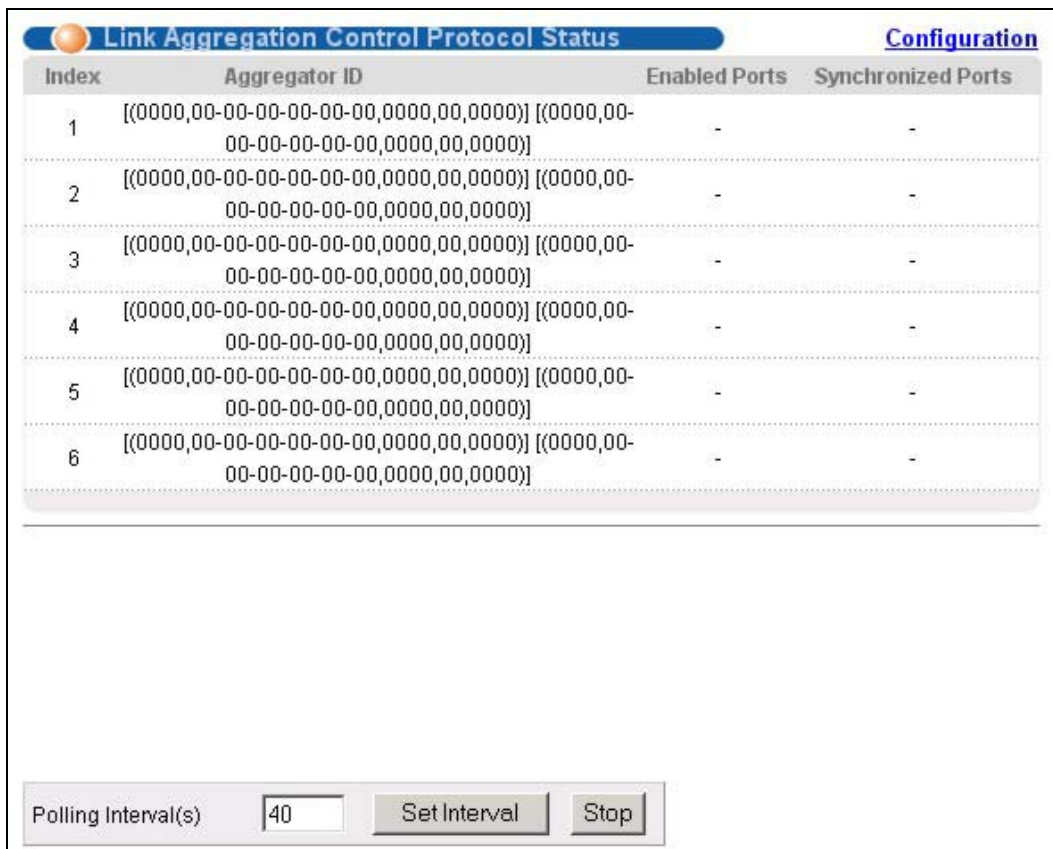

Figure 14-2 Link Aggregation: Link Aggregation Protocol Status

¹ This is “0” as it is the aggregator ID for the link aggregation group, not the individual port.

The following table describes the labels in this screen.

Table 14-1 Link Aggregation: Link Aggregation Protocol Status

LABEL	DESCRIPTION
Index	This field displays the trunk ID to identify a trunk group, that is, one logical link containing multiple ports.
Aggregator ID	Refer to <i>Figure 14-1</i> for more information on this field.
Enabled Ports	These are the ports you have configured in the Link Aggregation screen to be in the trunk group.
Synchronized Ports	These are the ports that are currently transmitting data as one logical link in this trunk group.
Poll Interval(s)	The text box displays how often (in seconds) this screen refreshes. You may change the refresh interval by typing a new number in the text box and then clicking Set Interval .
Stop	Click Stop to halt statistic polling.

14.3 Link Aggregation Setup

Click **Configuration** in the **Link Aggregation Protocol Status** screen to display the screen shown next.

You can configure up to six link aggregation groups and each group can aggregate up to eight ports.

Link Aggregation
Status

Link Aggregation Control Protocol

Active

System Priority

Group ID	Active	Dynamic(LACP)
T1	<input type="checkbox"/>	<input type="checkbox"/>
T2	<input type="checkbox"/>	<input type="checkbox"/>
T3	<input type="checkbox"/>	<input type="checkbox"/>
T4	<input type="checkbox"/>	<input type="checkbox"/>
T5	<input type="checkbox"/>	<input type="checkbox"/>
T6	<input type="checkbox"/>	<input type="checkbox"/>

Port	Group	LACP Timeout
1	None	30 seconds
2	None	30 seconds
3	None	30 seconds
4	None	30 seconds
5	None	30 seconds
6	None	30 seconds
7	T5	30 seconds
8	None	30 seconds
9	None	30 seconds
10	None	30 seconds
11	None	30 seconds
12	None	30 seconds
13	None	30 seconds
14	None	30 seconds
15	None	30 seconds
16	None	30 seconds
17	None	30 seconds
18	None	30 seconds
19	None	30 seconds
20	None	30 seconds
21	None	30 seconds
22	None	30 seconds
23	None	30 seconds
24	None	30 seconds
25	None	30 seconds
26	None	30 seconds
27	None	30 seconds
28	None	30 seconds

Figure 14-3 Link Aggregation: Configuration

The following table describes the labels in this screen.

Table 14-2 Link Aggregation: Configuration

LABEL	DESCRIPTION
Link Aggregation Control Protocol	
Active	Select this checkbox to enable Link Aggregation Control Protocol (LACP).
System Priority	LACP system priority is a number between 1 and 65,355. The switch with the lowest system priority (and lowest port number if system priority is the same) becomes the LACP “server”. The LACP “server” controls the operation of LACP setup. Enter a number to set the priority of an active port using Link Aggregate Control Protocol (LACP). The smaller the number, the higher the priority level.
Group ID	The field identifies the link aggregation group, that is, one logical link containing multiple ports
Active	Select this option to activate a trunk group.
Dynamic (LACP)	Select this check box to enable LACP for a trunk.
Port	This field displays the port number.
Group	Select the trunk group to which a port belongs.
LACP Timeout	Timeout is the time interval between the individual port exchanges of LACP packets in order to check that the peer port in the trunk group is still up. If a port does not respond after three tries, then it is deemed to be “down” and is removed from the trunk. Set a short timeout (one second) for busy trunked links to ensure that disabled ports are removed from the trunk group as soon as possible. Select either 1 second or 30 seconds.
Apply	Click Apply to save your changes back to the switch.
Cancel	Click Cancel to begin configuring this screen afresh.

Chapter 15

Port Authentication

This chapter describes the 802.1x authentication method and RADIUS server connection setup.

15.1 Introduction to Authentication

IEEE 802.1x is an extended authentication protocol² that allows support of RADIUS (Remote Authentication Dial In User Service, RFC 2138, 2139) for centralized user profile management on a network RADIUS server.

15.1.1 RADIUS

RADIUS (Remote Authentication Dial-In User Service) authentication is a popular protocol used to authenticate users by means of an external server instead of (or in addition to) an internal device user database that is limited to the memory capacity of the device. In essence, RADIUS authentication allows you to validate an unlimited number of users from a central location.



Figure 15-1 RADIUS Server

15.2 Configuring Port Authentication

To enable port authentication, first activate IEEE802.1x security (both on the ES-3124 and the port(s)) then configure the RADIUS server settings.

Click **Port Authentication** under **Advanced Application** in the navigation panel to display the screen as shown.

² Not all Windows operating systems support IEEE 802.1X (see the Microsoft web site for details). For other operating systems, see its documentation. If your operating system does not support IEEE 802.1X, then you may need to install IEEE 802.1X client software.



Figure 15-2 Port Authentication

15.2.1 Configuring RADIUS Server Settings

From the **Port Authentication** screen, click **RADIUS** to display the configuration screen as shown.

Figure 15-3 Port Authentication: RADIUS

The following table describes the labels in this screen.

Table 15-1 Port Authentication: RADIUS

LABEL	DESCRIPTION
Authentication Server	
IP Address	Enter the IP address of the external RADIUS server in dotted decimal notation.
UDP Port	The default port of the RADIUS server for authentication is 1812 . You need not change this value unless your network administrator instructs you to do so.
Shared Secret	Specify a password (up to 31 alphanumeric characters) as the key to be shared between the external RADIUS server and the switch. This key is not sent over the network. This key must be the same on the external RADIUS server and the switch.
Apply	Click Apply to save your changes back to the switch.
Cancel	Click Cancel to begin configuring this screen afresh.

15.2.2 Configuring IEEE802.1x

From the **Port Authentication** screen, click **802.1x** to display the configuration screen as shown.

802.1x
Port Authentication

Active

Port	Active	Reauthentication	Reauthentication Timer
1	<input type="checkbox"/>	On ▼	3600 seconds
2	<input type="checkbox"/>	On ▼	3600 seconds
3	<input type="checkbox"/>	On ▼	3600 seconds
4	<input type="checkbox"/>	On ▼	3600 seconds
5	<input type="checkbox"/>	On ▼	3600 seconds
6	<input type="checkbox"/>	On ▼	3600 seconds
7	<input type="checkbox"/>	On ▼	3600 seconds
8	<input type="checkbox"/>	On ▼	3600 seconds
9	<input type="checkbox"/>	On ▼	3600 seconds
10	<input type="checkbox"/>	On ▼	3600 seconds
11	<input type="checkbox"/>	On ▼	3600 seconds
12	<input type="checkbox"/>	On ▼	3600 seconds
13	<input type="checkbox"/>	On ▼	3600 seconds
14	<input type="checkbox"/>	On ▼	3600 seconds
15	<input type="checkbox"/>	On ▼	3600 seconds
16	<input type="checkbox"/>	On ▼	3600 seconds
17	<input type="checkbox"/>	On ▼	3600 seconds
18	<input type="checkbox"/>	On ▼	3600 seconds
19	<input type="checkbox"/>	On ▼	3600 seconds
20	<input type="checkbox"/>	On ▼	3600 seconds
21	<input type="checkbox"/>	On ▼	3600 seconds
22	<input type="checkbox"/>	On ▼	3600 seconds
23	<input type="checkbox"/>	On ▼	3600 seconds
24	<input type="checkbox"/>	On ▼	3600 seconds
25	<input type="checkbox"/>	On ▼	3600 seconds
26	<input type="checkbox"/>	On ▼	3600 seconds
27	<input type="checkbox"/>	On ▼	3600 seconds
28	<input type="checkbox"/>	On ▼	3600 seconds

Figure 15-4 Port Authentication: 802.1x

The following table describes the labels in this screen.

Table 15-2 Port Authentication: 802.1x

LABEL	DESCRIPTION
Active	Select this check box to permit 802.1x authentication on the switch.
	You must first allow 802.1x authentication on the switch before configuring it on each port.
Port	This field displays a port number.
Active	Select this checkbox to permit 802.1x authentication on this port. You must first allow 802.1x authentication on the switch before configuring it on each port.
Reauthentication	Specify if a subscriber has to periodically re-enter his or her username and password to stay connected to the port.
Reauthentication Timer	Specify how often a client has to re-enter his or her username and password to stay connected to the port.
Apply	Click Apply to save your changes back to the switch.
Cancel	Click Cancel to begin configuring this screen afresh.

Chapter 16

Port Security

This chapter shows you how to set up port security.

16.1 About Port Security

Port security allows only packets with dynamically learned MAC addresses and/or configured static MAC addresses to pass through a port on the switch. The switch can learn up to 16K MAC addresses in total with no limit on individual ports other than the sum cannot exceed 16K.

For maximum port security, enable this feature, disable MAC address learning and configure static MAC address(es) for a port. It is not recommended you disable **Port Security** together with MAC address learning as this will result in many broadcasts. By default, MAC address learning is still enabled even though the port security is not activated.

16.2 Port Security Setup

Click **Port Security** in the navigation panel to display the screen as shown.

Port Security

Active

Port	Active	Address Learning	Limited Number of Learned MAC Address
1	<input type="checkbox"/>	<input checked="" type="checkbox"/>	0
2	<input type="checkbox"/>	<input checked="" type="checkbox"/>	0
3	<input type="checkbox"/>	<input checked="" type="checkbox"/>	0
4	<input type="checkbox"/>	<input checked="" type="checkbox"/>	0
5	<input type="checkbox"/>	<input checked="" type="checkbox"/>	0
6	<input type="checkbox"/>	<input checked="" type="checkbox"/>	0
7	<input type="checkbox"/>	<input checked="" type="checkbox"/>	0
8	<input type="checkbox"/>	<input checked="" type="checkbox"/>	0
9	<input type="checkbox"/>	<input checked="" type="checkbox"/>	0
10	<input type="checkbox"/>	<input checked="" type="checkbox"/>	0
11	<input type="checkbox"/>	<input checked="" type="checkbox"/>	0
12	<input type="checkbox"/>	<input checked="" type="checkbox"/>	0
13	<input type="checkbox"/>	<input checked="" type="checkbox"/>	0
14	<input type="checkbox"/>	<input checked="" type="checkbox"/>	0
15	<input type="checkbox"/>	<input checked="" type="checkbox"/>	0
16	<input type="checkbox"/>	<input checked="" type="checkbox"/>	0
17	<input type="checkbox"/>	<input checked="" type="checkbox"/>	0
18	<input type="checkbox"/>	<input checked="" type="checkbox"/>	0
19	<input type="checkbox"/>	<input checked="" type="checkbox"/>	0
20	<input type="checkbox"/>	<input checked="" type="checkbox"/>	0
21	<input type="checkbox"/>	<input checked="" type="checkbox"/>	0
22	<input type="checkbox"/>	<input checked="" type="checkbox"/>	0
23	<input type="checkbox"/>	<input checked="" type="checkbox"/>	0
24	<input type="checkbox"/>	<input checked="" type="checkbox"/>	0
25	<input type="checkbox"/>	<input checked="" type="checkbox"/>	0
26	<input type="checkbox"/>	<input checked="" type="checkbox"/>	0
27	<input type="checkbox"/>	<input checked="" type="checkbox"/>	0
28	<input type="checkbox"/>	<input checked="" type="checkbox"/>	0

Apply Cancel

Figure 16-1 Port Security

The following table describes the labels in this screen.

Table 16-1 Port Security

LABEL	DESCRIPTION
Active	Select this check box to enable the port security feature on the switch.
Port	This field displays a port number.
Active	<p>Select this check box to enable the port security feature on this port. The switch forwards packet(s) whose MAC address(es) is in the MAC address table on this port. Packet(s) with no matching MAC address(es) are dropped.</p> <p>Clear this check box to disable the port security feature. The switch forwards all packets on this port.</p>
Address Learning	MAC address learning reduces outgoing broadcast traffic. For MAC address learning to occur on a port, the port itself must be active with address learning enabled.
Limited Number of Learned MAC Address	Use this field to limit the number of (dynamic) MAC addresses that may be learned on a port. For example, if you set this field to "5" on port 2, then only the devices with these five learned MAC addresses may access port 2 at any one time. A sixth device would have to wait until one of the five learned MAC addresses aged out. MAC-address aging out time can be set in the Switch Setup screen. The valid range is from 0 to 16K. 0 means this feature is disabled, so the switch will learn MAC addresses up to the global limit of 16K.
Apply	Click Apply to save your changes back to the switch.
Cancel	Click Cancel to begin configuring this screen afresh.

Chapter 17

Access Control

This chapter describes how to control access to the switch.

17.1 About Access Control

Click **Access Control** from the navigation panel to display the screen as shown. From this screen you can configure SNMP, up to four web configurator administrators, enable/disable remote service access and configure trusted computers for remote access.



Figure 17-1 Access Control

17.2 Access Control Overview

A console port access control session and Telnet access control session cannot coexist. The console port has higher priority. If you telnet to the switch and someone is already logged in from the console port, then you will see the following message.

```
"Local administrator is configuring this device now!!!  
Connection to host lost."
```

Figure 17-2 Console Port Priority

A console port or Telnet session can coexist with one FTP session, up to five Web sessions (five different usernames and passwords) and/or limitless SNMP access control sessions.

Table 17-1 Access Control Summary

	Console port	Telnet	FTP	Web	SNMP
Number of sessions allowed	1	1	1	5	No limit
Number of concurrent sessions allowed	1 console port or Telnet. Console port has priority.		1	5	No limit

17.3 About SNMP

Simple Network Management Protocol is a protocol used for exchanging management information between network switches. SNMP is a member of TCP/IP protocol suite. A manager station can manage and monitor the ES-3124 through the network via SNMP version one (SNMPv1) and/or SNMP version 2c. The next figure illustrates an SNMP management operation. SNMP is only available if TCP/IP is configured.

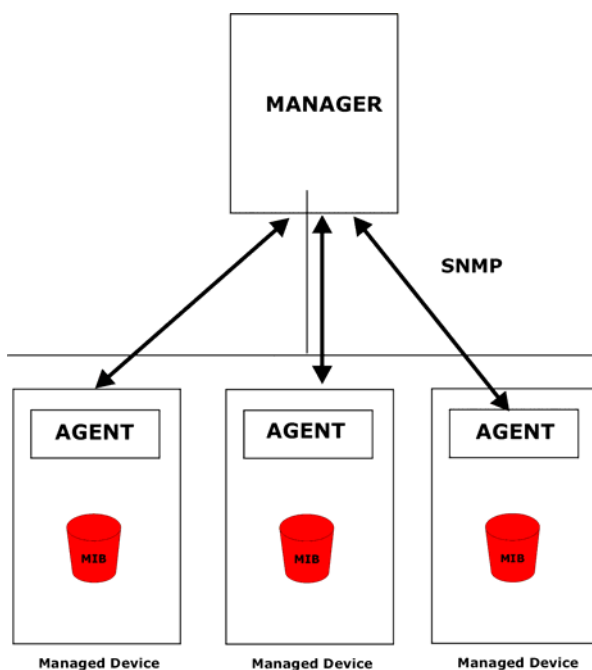
**Figure 17-3 SNMP Management Model**

An SNMP managed network consists of two main components: agents and a manager.

An agent is a management software module that resides in a managed switch (the ES-3124). An agent translates the local management information from the managed switch into a form compatible with SNMP. The manager is the console through which network administrators perform network management functions. It executes applications that control and monitor managed devices.

The managed devices contain object variables/managed objects that define each piece of information to be collected about a switch. Examples of variables include such as number of packets received, node port status etc. A Management Information Base (MIB) is a collection of managed objects. SNMP allows a manager and agents to communicate for the purpose of accessing these objects.

SNMP itself is a simple request/response protocol based on the manager/agent model. The manager issues a request and the agent returns responses using the following protocol operations:

Table 17-2 SNMP Commands

COMMAND	DESCRIPTION
Get	Allows the manager to retrieve an object variable from the agent.
GetNext	Allows the manager to retrieve the next object variable from a table or list within an agent. In SNMPv1, when a manager wants to retrieve all elements of a table from an agent, it initiates a Get operation, followed by a series of GetNext operations.
Set	Allows the manager to set values for object variables within an agent.
Trap	Used by the agent to inform the manager of some events.

17.3.1 Supported MIBs

MIBs let administrators collect statistics and monitor status and performance.

The ES-3124 supports the following MIBs:

- SNMP MIB II (RFC 1213)
- RFC 1157 SNMP v1
- RFC 1493 Bridge MIBs
- RFC 1643 Ethernet MIBs
- RFC 1155 SMI
- RFC 2674 SNMPv2, SNMPv2c
- RFC 1757 RMON
- SNMPv2, SNMPv2c or later version, compliant with RFC 2011 SNMPv2 MIB for IP, RFC 2012 SNMPv2 MIB for TCP, RFC 2013 SNMPv2 MIB for UDP

17.3.2 SNMP Traps

The ES-3124 sends traps to an SNMP manager when an event occurs. SNMP traps supported are outlined in the following table.

Table 17-3 SNMP Traps

GENERIC TRAP	SPECIFIC TRAP	DESCRIPTION
0 (Cold Start)	0	This trap is sent when the ES-3124 is turned on.
1 (WarmStart)	0	This trap is sent when the ES-3124 restarts.
2 (linkDown)	0	This trap is sent when the Ethernet link is down.
3 (linkUp)	0	This trap is sent when the Ethernet link is up.
4 (authenticationFailure)	0	This trap is sent when an SNMP request comes from non-authenticated hosts.

17.3.3 Configuring SNMP

From the **Access Control** screen, display the **SNMP** screen. You can click **Access Control** to go back to the **Access Control** screen.

Figure 17-4 Access Control: SNMP

The following table describes the labels in this screen.

Table 17-4 Access Control: SNMP

LABEL	DESCRIPTION
Get Community	Enter the get community, which is the password for the incoming Get- and GetNext- requests from the management station.
Set Community	Enter the set community, which is the password for incoming Set- requests from the management station.
Trap Community	Enter the trap community, which is the password sent with each trap to the SNMP manager.
Trap Destination	Enter the IP addresses of up to four stations to send your SNMP traps to.
Apply	Click Apply to save your changes back to the switch.
Cancel	Click Cancel to begin configuring this screen afresh.

17.3.4 Setting Up Login Accounts

Up to five people (one administrator and four non-administrators) may access the switch via web configurator at any one time.

1. An administrator is someone who can both view and configure switch changes. The username for the administrator is always **admin**. The default administrator password is **1234**.

It is highly recommended that you change the default administrator password ("1234").

2. A non-administrator (username is something other than **admin**) is someone who can view but not configure switch changes.

Click **Access Control** from the navigation panel and then click Logins from this screen.

Logins Administrator **Access Control**

Old Password

New Password

Retype to confirm

Please record your new password whenever you change it. The system will lock you out if you have forgotten your password.

Edit Logins

Login	User Name	Password	Retype to confirm
1	<input type="text"/>	<input type="text"/>	<input type="text"/>
2	<input type="text"/>	<input type="text"/>	<input type="text"/>
3	<input type="text"/>	<input type="text"/>	<input type="text"/>
4	<input type="text"/>	<input type="text"/>	<input type="text"/>

Apply Cancel

Figure 17-5 Access Control: Logins

The following table describes the labels in this screen.

Table 17-5 Access Control: Logins

LABEL	DESCRIPTION
Administrator	This is the default administrator account with the “admin” user name. You cannot change the default administrator user name. Only the administrator has read/write access.
Old Password	Type the existing system password (“1234” is the default password when shipped).
New Password	Enter your new system password.
Retype to confirm	Retype your new system password for confirmation
Edit Logins	You may configure passwords for up to four users. These people have read-only access.
User Name	Set a user name (up to 30 characters long).
Password	Enter a password for the user name above.
Retype to confirm	Type the password again for confirmation

Table 17-5 Access Control: Logins

LABEL	DESCRIPTION
Apply	Click Apply to save your changes back to the switch.
Cancel	Click Cancel to begin configuring this screen afresh.

17.4 Service Access Control

Service Access Control allows you to decide what services you may use to access the ES-3124. You may also change the default service port and configure “trusted computer(s)” for each service in the **Remote Management** screen (discussed later). Click **Access Control** to go back to the **Access Control** screen.

Services	Active	Service Port
Telnet	<input checked="" type="checkbox"/>	23
FTP	<input checked="" type="checkbox"/>	21
Web	<input checked="" type="checkbox"/>	80
ICMP	<input checked="" type="checkbox"/>	
SNMP	<input checked="" type="checkbox"/>	

Apply Cancel

Figure 17-6 Access Control: Service Access Control

The following table describes the fields in this screen.

Table 17-6 Access Control: Service Access Control

LABEL	DESCRIPTION
Services	Services you may use to access the ES-3124 are listed here.
Active	Select the Active check boxes for the corresponding services that you want to allow to access the ES-3124.
Service Port	For Telnet, FTP or web services, you may change the default service port by typing the new port number in the Service Port field. If you change the default port number then you will have to let people (who wish to use the service) know the new port number for that service.
Apply	Click Apply to save your changes back to the switch.
Cancel	Click Cancel to begin configuring this screen afresh.

17.5 Remote Management

From the **Access Control** screen, display the **Remote Management** screen as shown next.

You can specify a group of one or more “trusted computers” from which an administrator may use a service to manage the switch. Click **Access Control** to return to the **Access Control** screen.

Entry	Active	Start Address	End Address	Telnet	FTP	Web	ICMP	SNMP
1	<input checked="" type="checkbox"/>	0.0.0.0	0.0.0.0	<input checked="" type="checkbox"/>	<input checked="" type="checkbox"/>	<input checked="" type="checkbox"/>	<input checked="" type="checkbox"/>	<input checked="" type="checkbox"/>
2	<input type="checkbox"/>	0.0.0.0	0.0.0.0	<input type="checkbox"/>	<input type="checkbox"/>	<input type="checkbox"/>	<input type="checkbox"/>	<input type="checkbox"/>
3	<input type="checkbox"/>	0.0.0.0	0.0.0.0	<input type="checkbox"/>	<input type="checkbox"/>	<input type="checkbox"/>	<input type="checkbox"/>	<input type="checkbox"/>
4	<input type="checkbox"/>	0.0.0.0	0.0.0.0	<input type="checkbox"/>	<input type="checkbox"/>	<input type="checkbox"/>	<input type="checkbox"/>	<input type="checkbox"/>

Figure 17-7 Access Control: Remote Management

The following table describes the labels in this screen.

Table 17-7 Access Control: Remote Management

LABEL	DESCRIPTION
Entry	This is the client set index number. A “client set” is a group of one or more “trusted computers” from which an administrator may use a service to manage the switch.
Active	Select this check box to activate this secured client set. Clear the check box if you wish to temporarily disable the set without deleting it.
Start Address End Address	Configure the IP address range of trusted computers from which you can manage this switch. The switch checks if the client IP address of a computer requesting a service or protocol matches the range set here. The switch immediately disconnects the session if it does not match.
Telnet/FTP/Web/ICMP/SNMP	Select services that may be used for managing the switch from the specified trusted computers.
Apply	Click Apply to save your changes back to the switch.
Cancel	Click Cancel to begin configuring this screen afresh.

Chapter 18

Queuing Method

This chapter introduces SP (Strictly Priority) and WFS (Weighted Fair Scheduling).

18.1 Introduction to Queuing

Queuing is used to help solve performance degradation when there is network congestion. Use the **Queuing Method** screen to configure queuing algorithms for outgoing traffic. See also **Priority Queue Assignment** in **Switch Setup** and **802.1p Priority** in **Port Setup** for related information.

Queuing algorithms allow switches to maintain separate queues for packets from each individual source or flow and prevent a source from monopolizing the bandwidth.

18.1.1 Strictly Priority

Strictly Priority (SP) services queues based on priority only. As traffic comes into the switch, traffic on the highest priority queue, Q7 is transmitted first. When that queue empties, traffic on the next highest-priority queue, Q6 is transmitted until Q6 empties, and then traffic is transmitted on Q5 and so on. If higher priority queues never empty, then traffic on lower priority queues never gets sent. SP does not automatically adapt to changing network requirements.

18.1.2 Weighted Fair Scheduling

Weighted Fair Scheduling is used to guarantee each queue's minimum bandwidth based on their bandwidth weight (portion) (the number you configure in the **Weight** field – see *Figure 18-1*) when there is traffic congestion. WFS is activated only when a port has more traffic than it can handle. Queues with larger weights get more guaranteed bandwidth than queues with smaller weights. This queuing mechanism is highly efficient in that it divides any available bandwidth across the different traffic queues. By default, the weight for Q0 is 1, for Q1 is 2, for Q2 is 3, and so on. Guaranteed bandwidth is calculated as follows:

$$\frac{\text{Queue Weight}}{\text{Total Queue Weight}} \times \text{Port Speed}$$

For example, using the default setting, Q0 on Port 1 gets a guaranteed bandwidth of:

$$\frac{1}{1+2+3+4+5+6+7+8} \times 100 \text{ Mbps} = 3 \text{ Mbps}$$

18.2 Configuring Queuing

Click **Queuing Method** under **Advanced Application** in the navigation panel.

● Queuing Method

Method

Strictly Priority
 Weighted Fair Scheduling

Port	Weight							
	Q0	Q1	Q2	Q3	Q4	Q5	Q6	Q7
1	1	2	3	4	5	6	7	8
2	1	2	3	4	5	6	7	8
3	1	2	3	4	5	6	7	8
4	1	2	3	4	5	6	7	8
5	1	2	3	4	5	6	7	8
6	1	2	3	4	5	6	7	8
7	1	2	3	4	5	6	7	8
8	1	2	3	4	5	6	7	8
9	1	2	3	4	5	6	7	8
10	1	2	3	4	5	6	7	8
11	1	2	3	4	5	6	7	8
12	1	2	3	4	5	6	7	8
13	1	2	3	4	5	6	7	8
14	1	2	3	4	5	6	7	8
15	1	2	3	4	5	6	7	8
16	1	2	3	4	5	6	7	8
17	1	2	3	4	5	6	7	8
18	1	2	3	4	5	6	7	8
19	1	2	3	4	5	6	7	8
20	1	2	3	4	5	6	7	8
21	1	2	3	4	5	6	7	8
22	1	2	3	4	5	6	7	8
23	1	2	3	4	5	6	7	8
24	1	2	3	4	5	6	7	8
25	1	2	3	4	5	6	7	8
26	1	2	3	4	5	6	7	8
27	1	2	3	4	5	6	7	8
28	1	2	3	4	5	6	7	8

Figure 18-1 Queuing Method

The following table describes the labels in this screen.

Table 18-1 Queuing Method

LABEL	DESCRIPTION
Method	<p>Select Strictly Priority or Weighted Fair Scheduling.</p> <p>Strictly Priority services queues based on priority only. When the highest priority queue empties, traffic on the next highest-priority queue begins. Q7 has the highest priority and Q0 the lowest.</p> <p>Weighted Fair Scheduling is used to guarantee each queue's minimum bandwidth based on their bandwidth portion (weight) (the number you configure in the Weight field). Queues with larger weights get more guaranteed bandwidth than queues with smaller weights.</p>
Port	This label shows the port you are configuring.
Weight	<p>When you select Weighted Fair Scheduling, enter the queue weight here. Bandwidth is divided across the different traffic queues according to their weights.</p> <p>For Gigabit ports, if you enter 0 for the queue weight, the switch uses Strictly Priority to service the queue.</p>
Apply	Click Apply to save your changes back to the switch.
Cancel	Click Cancel to begin configuring this screen afresh.

Chapter 19

Classifier

This chapter introduces and shows you how to configure the packet classifier on the ES-3124.

19.1 About the Classifier and QoS

Quality of Service (QoS) refers to both a network's ability to deliver data with minimum delay, and the networking methods used to control the use of bandwidth. Without QoS, all traffic data is equally likely to be dropped when the network is congested. This can cause a reduction in network performance and make the network inadequate for time-critical application such as video-on-demand.

A classifier groups traffic into data flows according to specific criteria such as the source address, destination address, source port number, destination port number or incoming port number. For example, you can configure a classifier to select traffic from the same protocol port (such as Telnet) to form a flow.

Configure QoS on the switch to group and prioritize application traffic and fine-tune network performance. Setting up QoS involves two separate steps:

1. Configure classifiers to sort traffic into different flows.
2. Configure policy rules to define actions to be performed for a classified traffic flow (refer to *Chapter 20* to configure policy rules).

19.2 Configuring the Classifier

Use the **Classifier** screen to define the classifiers. After you define the classifier, you can specify actions (or policy) to act upon the traffic that match the rules. To configure policy rules, refer to *Chapter 20*.

Click **Advanced Application** and **Classifier** in the navigation panel to display the configuration screen as shown.

● **Classifier**

Active

Name

Packet Format All ▾

VLAN Any

Ethernet Type All ▾ Others (Hex)

Layer 2

Source **MAC Address** Any MAC : : : : :

Port All Port ▾

Destination **MAC Address** Any MAC : : : : :

IP Protocol All ▾ Establish Only Others (Dec)

Layer 3

Source **IP Address / Address Prefix** 0.0.0.0 /

Socket Number Any

Destination **IP Address / Address Prefix** 0.0.0.0 /

Socket Number Any

Index	Active	Name	Rule	Delete
<input type="button" value="Delete"/> <input type="button" value="Cancel"/>				

Figure 19-1 Classifier

The following table describes the labels in this screen.

Table 19-1 Classifier

LABEL	DESCRIPTION
Active	Select this option to enable this rule.
Name	Enter a descriptive name for this rule for identifying purposes.

Table 19-1 Classifier

LABEL	DESCRIPTION
Packet Format	<p>Specify the format of the packet. Choices are All, 802.3 tagged, 802.3 untagged, Ethernet II tagged and Ethernet II untagged.</p> <p>A value of 802.3 indicates that the packets are formatted according to the IEEE 802.3 standards.</p> <p>A value of Ethernet II indicates that the packets are formatted according to RFC 894, Ethernet II encapsulation.</p>
VLAN	Select Any to classify traffic from any VLAN or select the second option and specify the source VLAN ID in the field provided.
<p>Layer 2</p> <p>Specify the fields below to configure a layer 2 classifier.</p>	
Ethernet Type	Select an Ethernet type or select Other and enter the Ethernet type number in hexadecimal value. Refer to <i>Table 19-3</i> for information.
Source	
MAC Address	<p>Select Any to apply the rule to all MAC addresses.</p> <p>To specify a source, select the second choice and type a MAC address in valid MAC address format (six hexadecimal character pairs).</p>
Port	Select the port to which the rule should be applied. You may choose one port only or all ports (All Ports).
Destination	
MAC Address	<p>Select Any to apply the rule to all MAC addresses.</p> <p>To specify a destination, select the second choice and type a MAC address in valid MAC address format (six hexadecimal character pairs).</p>
<p>Layer 3</p> <p>Specify the fields below to configure a layer 3 classifier.</p>	
IP Protocol	<p>Select an IP protocol type or select Other and enter the protocol number in decimal value. Refer to <i>Table 19-4</i> for more information.</p> <p>You may select Establish Only for TCP protocol type. This means that the switch will pick out the packets that are sent to establish TCP connections.</p>
Source	
IP Address/Address Prefix	<p>Enter a source IP address in dotted decimal notation.</p> <p>Specify the address prefix by entering the number of ones in the subnet mask.</p>
Socket Number	<p>You must select either UDP or TCP in the IP Protocol field before you configure the socket numbers.</p> <hr/> <p>Select Any to apply the rule to all TCP/UDP protocol port numbers or select the second option and enter a TCP/UDP protocol port number.</p>
Destination	
IP Address/Address Prefix	<p>Enter a destination IP address in dotted decimal notation.</p> <p>Specify the address prefix by entering the number of ones in the subnet mask.</p>

Table 19-1 Classifier

LABEL	DESCRIPTION
Socket Number	You must select either UDP or TCP in the IP Protocol field before you configure the socket numbers. Select Any to apply the rule to all TCP/UDP protocol port numbers or select the second option and enter a TCP/UDP protocol port number.
Add	Click Add to insert the entry in the summary table below.
Cancel	Click Cancel to reset the fields back to your previous configuration.
Clear	Click Clear to set the above fields back to the factory defaults.

19.3 Viewing and Editing Classifier Configuration

To view a summary of the classifier configuration, scroll down to the summary table at the bottom of the **Classifier** screen. To change the settings of a rule, click a number in the **Index** field.

When two rules conflict with each other, a higher layer rule has priority over lower layer rule.

Index	Active	Name	Rule	Delete
1	Yes	Example	EtherType = IP; SrcMac = 00:50:ba:ad:41:81; SrcPort = port 2;	<input type="checkbox"/>

Delete Cancel

Figure 19-2 Classifier: Summary Table

The following table describes the labels in this screen.

Table 19-2 Classifier: Summary Table

LABEL	DESCRIPTION
Index	This field displays the index number of the rule. Click an index number to edit the rule.
Active	This field displays Yes when the rule is activated and No when is it deactivated.
Name	This field displays the descriptive name for this rule. This is for identification purpose only.
Rule	This field displays a summary of the classifier rule's settings.
Delete	Click Delete to remove the selected entry from the summary table.
Cancel	Click Cancel to clear the Delete check boxes.

The following table shows some other common Ethernet types and the corresponding protocol number.

Table 19-3 Common Ethernet Types and Protocol Number

ETHERNET TYPE	PROTOCOL NUMBER
IP ETHII	0800
X.75 Internet	0801

Table 19-3 Common Ethernet Types and Protocol Number

ETHERNET TYPE	PROTOCOL NUMBER
NBS Internet	0802
ECMA Internet	0803
Chaosnet	0804
X.25 Level 3	0805
XNS Compat	0807
Banyan Systems	0BAD
BBN Simnet	5208
IBM SNA	80D5
AppleTalk AARP	80F3

Some of the most common IP ports are:

Table 19-4 Common IP Ports

PORT NUMBER	PORT NAME
21	FTP
23	Telnet
25	SMTP
53	DNS
80	HTTP
110	POP3

19.4 Classifier Example

The following figure shows an example where you configure a classifier that identifies all traffic from MAC address 00:50:ba:ad:4f:81 on port 2.

● **Classifier**

Active	<input checked="" type="checkbox"/>		
Name	<input type="text" value="Example"/>		
Packet Format	<input type="text" value="All"/>		
VLAN	<input checked="" type="radio"/> Any <input type="radio"/> <input type="text"/>		
Layer 2	Ethernet Type	<input checked="" type="radio"/> IP <input type="text"/> <input type="radio"/> Others <input type="text"/> (Hex)	
	Source MAC Address	<input type="radio"/> Any <input checked="" type="radio"/> MAC <input type="text" value="00"/> : <input type="text" value="50"/> : <input type="text" value="ba"/> : <input type="text" value="ad"/> : <input type="text" value="4f"/> : <input type="text" value="81"/>	
	Port	<input type="text" value="Port 2"/>	
	Destination MAC Address	<input checked="" type="radio"/> Any <input type="radio"/> MAC <input type="text"/> : <input type="text"/> : <input type="text"/> : <input type="text"/> : <input type="text"/> : <input type="text"/>	
Layer 3	IP Protocol	<input checked="" type="radio"/> All <input type="text"/> <input type="checkbox"/> Establish Only <input type="radio"/> Others <input type="text"/> (Dec)	
	Source IP Address / Address Prefix	<input type="text" value="0.0.0.0"/> / <input type="text"/>	
	Socket Number	<input checked="" type="radio"/> Any <input type="radio"/> <input type="text"/>	
	Destination IP Address / Address Prefix	<input type="text" value="0.0.0.0"/> / <input type="text"/>	
	Socket Number	<input checked="" type="radio"/> Any <input type="radio"/> <input type="text"/>	

Figure 19-3 Classifier: Example

Chapter 20

Policy Rule

This chapter shows you how to configure policy rules.

20.1 About Policy Rules

A classifier distinguishes traffic into flows based on the configured criteria (refer to *Chapter 19* for more information). A policy rule ensures that a traffic flow gets the requested treatment in the network.

20.1.1 DiffServ

DiffServ (Differentiated Services) is a class of service (CoS) model that marks packets so that they receive specific per-hop treatment at DiffServ-compliant network devices along the route based on the application types and traffic flow. Packets are marked with DiffServ Code Points (DSCPs) indicating the level of service desired. This allows the intermediary DiffServ-compliant network devices to handle the packets differently depending on the code points without the need to negotiate paths or remember state information for every flow. In addition, applications do not have to request a particular service or give advanced notice of where the traffic is going.

20.1.2 DSCP and Per-Hop Behavior

DiffServ defines a new DS (Differentiated Services) field to replace the Type of Service (TOS) field in the IP header. The DS field contains a 2-bit unused field and a 6-bit DSCP field which can define up to 64 service levels. The following figure illustrates the DS field.

DSCP is backward compatible with the three precedence bits in the ToS octet so that non-DiffServ compliant, ToS-enabled network device will not conflict with the DSCP mapping.

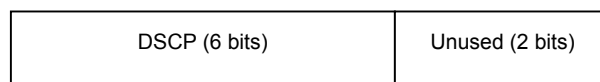

The DSCP value determines the forwarding behavior, the PHB (Per-Hop Behavior), that each packet gets across the DiffServ network. Based on the marking rule, different kinds of traffic can be marked for different kinds of forwarding. Resources can then be allocated according to the DSCP values and the configured policies.

20.2 Configuring Policy Rules

You must first configure a classifier in the **Classifier** screen. Refer to *Chapter 19* for more information.

Click **Advanced Applications** and then **Policy Rule** in the navigation panel to display the screen as shown.

● Policy

Active

Name

Classifier(s)

Parameters

VLAN ID

EgressPort

Outgoing packet format for Egress port Tag Untag

Priority

DSCP

TOS

General

Bandwidth Mbps

Out-of-Profile DSCP

Action

Forwarding

No change

Discard the packet

Do not drop the matching frame previously marked for dropping

Priority

No change

Set the packet's 802.1 priority

Send the packet to priority queue

Replace the 802.1 priority field with the IP TOS value

Diffserv

No change

Set the packet's TOS field

Replace the IP TOS field with the 802.1 priority value

Set the Diffserv Codepoint field in the frame

Outgoing

Send the packet to the mirror port

Send the packet to the egress port

Send the matching frames(broadcast or DLF, multicast, marked for dropping or to be sent to the CPU) to the egress port

Set the packet's VLAN ID

Metering

Enable

Out-of-profile action

Drop the packet

Change the DSCP value

Do not drop the matching frame previously marked for dropping

Index	Active	Name	Classifier(s)	Delete
<input type="button" value="Delete"/> <input type="button" value="Cancel"/>				

Figure 20-1 Policy

The following table describes the labels in this screen.

Table 20-1 Policy

LABEL	DESCRIPTION
Active	Select this option to enable the policy.
Name	Enter a descriptive name for identification purposes.
Classifier(s)	<p>This field displays the active classifier(s) you configure in the Classifier screen (refer to <i>Chapter 19</i>).</p> <p>Select the classifier(s) to which this policy rule applies. To select more than one classifier, press [SHIFT] and select the choices at the same time.</p>
<p>Parameters</p> <p>Set the fields below for this policy. You only have to set the field(s) that is related to the action(s) you configure in the Action field.</p>	
General	
VLAN ID	Specify a VLAN ID number.
Egress Port	Select an outgoing port.
Outgoing packet format for Egress port	Use the radio button to specify whether the packet is sent out with the tag or not.
Priority	Specify a priority level.
DSCP	Specify a DSCP (DiffServ Code Point) number between 0 and 63.
TOS	Specify the type of service (TOS) priority level.
Metering	
Bandwidth	Specify the bandwidth in mega bits per second (Mbps). Enter a number between 1 and 1023.
Out-of-Profile DSCP	Specify a new DSCP number (between 0 and 63) if you want to replace or remark the DSCP number for out-of-profile traffic.
Action	
Specify the action(s) the switch takes on the associated classified traffic flow.	
Forwarding	<p>Select No change to forward the packets.</p> <p>Select Discard packet to drop the packets.</p> <p>Select Do not drop the matching frame previously marked for dropping to retain the frames that were marked to be dropped before.</p>
Priority	<p>Select No change to keep the priority setting of the frames.</p> <p>Select Set the packet's 802.1 priority to replace the packet's 802.1 priority field with the value you set in the Priority field.</p> <p>Select Send the packet to priority queue to put the packets in the designated queue.</p> <p>Select Replace the 802.1 priority field with IP TOS value to replace the packet's 802.1 priority field with the value you set in the TOS field.</p>

Table 20-1 Policy

LABEL	DESCRIPTION
Diffserv	Select No change to keep the TOS and/or DSCP fields in the packets. Select Set the packet's TOS field to set the TOS field with the value you configure in the TOS field. Select Replace the IP TOS with the 802.1 priority value to replace the TOS field with the value you configure in the Priority field. Select Set the Diffserv Codepoint field in the frame to set the DSCP field with the value you configure in the DSCP field.
Outgoing	Select Send the packet to the mirror port to send the packet to the mirror port. Select Send the packet to the egress port to send the packet to the egress port. Select Send the matching frames (broadcast or DLF, multicast, marked for dropping or to be sent to the CPU) to the egress port to send the broadcast, multicast, DLF, marked-to-drop or CPU frames to the egress port. Select Set the packet's VLANID to set the VLAN ID of the packet with the value you configure in the VLANID field.
Metering	Select Enable to activate bandwidth limitation on the traffic flow(s) then set the actions to be taken on out-of-profile packets.
Out-of-profile action	Select the action(s) to be performed for out-of-profile traffic. Select Drop the packet to discard the out-of-profile traffic. Select Change the DSCP Value to replace the DSCP field with the value specified in the Out of profile DSCP field. Select Do not drop the matching frame previously marked for dropping to queue the frames that are marked to be dropped.
Add	Click Add to inset the entry to the summary table below.
Cancel	Click Cancel to reset the fields back to your previous configuration.
Clear	Click Clear to set the above fields back to the factory defaults.

20.3 Viewing and Editing Policy Configuration

To view a summary of the classifier configuration, scroll down to the summary table at the bottom of the Policy screen. To change the settings of a rule, click a number in the Index field.

Index	Active	Name	Classifier(s)	Delete
1	Yes	test	Example;	<input type="checkbox"/>

Figure 20-2 Policy: Summary Table

The following table describes the labels in this screen.

Table 20-2 Policy: Summary Table

LABEL	DESCRIPTION
Index	This field displays the policy index number. Click an index number to edit the policy.
Active	This field displays Yes when policy is activated and No when is it deactivated.
Name	This field displays the descriptive name for this policy. This is for identification purposes only.
Classifier(s)	This field displays the name(s) of the classifier to which this policy applies.
Delete	Click Delete to remove the selected entry from the summary table.
Cancel	Click Cancel to clear the Delete check boxes.

20.4 Policy Example

The figure below shows an example Policy screen where you configure a policy to limit bandwidth and discard out-of-band traffic on a traffic flow classified using the Example classifier (refer to *Section 19.4*).

Policy

Active	<input checked="" type="checkbox"/>
Name	<input type="text" value="Test"/>
Classifier(s)	<input type="text" value="Example"/>

Parameters	VLAN ID <input type="text"/> EgressPort <input type="text" value="Port 1"/>	Metering	Bandwidth <input type="text" value="10"/> Mbps Out-of-Profile DSCP <input type="text" value="0"/>
	Outgoing packet format for Egress port <input checked="" type="radio"/> Tag <input type="radio"/> Untag Priority <input type="text" value="0"/> DSCP <input type="text"/> TOS <input type="text" value="0"/>		

Action	Forwarding <input checked="" type="radio"/> No change <input type="radio"/> Discard the packet <input type="radio"/> Do not drop the matching frame previously marked for dropping
	Priority <input checked="" type="radio"/> No change <input type="radio"/> Set the packet's 802.1 priority <input type="radio"/> Send the packet to priority queue <input type="radio"/> Replace the 802.1 priority field with the IP TOS value
	Diffserv <input checked="" type="radio"/> No change <input type="radio"/> Set the packet's TOS field <input type="radio"/> Replace the IP TOS field with the 802.1 priority value <input type="radio"/> Set the Diffserv Codepoint field in the frame
	Outgoing <input type="checkbox"/> Send the packet to the mirror port <input type="checkbox"/> Send the packet to the egress port <input type="checkbox"/> Send the matching frames(broadcast or DLF, multicast, marked for dropping or to be sent to the CPU) to the egress port <input type="checkbox"/> Set the packet's VLAN ID
	Metering <input checked="" type="checkbox"/> Enable
	Out-of-profile action <input checked="" type="checkbox"/> Drop the packet <input type="checkbox"/> Change the DSCP value <input type="checkbox"/> Do not drop the matching frame previously marked for dropping

Figure 20-3 Policy Example

Chapter 21

VLAN Stacking

This chapter shows you how to configure VLAN stacking on your ES-3124. See the chapter on VLANs for more background information on Virtual LAN

21.1 Introduction

A service provider can use VLAN stacking to allow it to distinguish multiple customers VLANs, even those with the same (customer-assigned) VLAN ID, within its network.

Use VLAN stacking to add an outer VLAN tag to the inner IEEE 802.1Q tagged frames that enter the network. By tagging the tagged frames (“double-tagged” frames), the service provider can manage up to 4,094 VLAN groups with each group containing up to 4,094 customer VLANs. This allows a service provider to provide different service, based on specific VLANs, for many different customers.

A service provider’s customers may require a range of VLANs to handle multiple applications. A service provider’s customers can assign their own inner VLAN tags on ports for these applications. The service provider can assign an outer VLAN tag for each customer. Therefore, there is no VLAN tag overlap among customers, so traffic from different customers is kept separate.

21.1.1 VLAN Stacking Example

In the following example figure, both A and B are Service Provider’s Network (SPN) customers with VPN tunnels between their head offices and branch offices respectively. Both have an identical VLAN tag for their VLAN group. The service provider can separate these two VLANs within its network by adding tag 37 to distinguish customer A and tag 48 to distinguish customer B at edge device 1 and then stripping those tags at edge device 2 as the data frames leave the network.

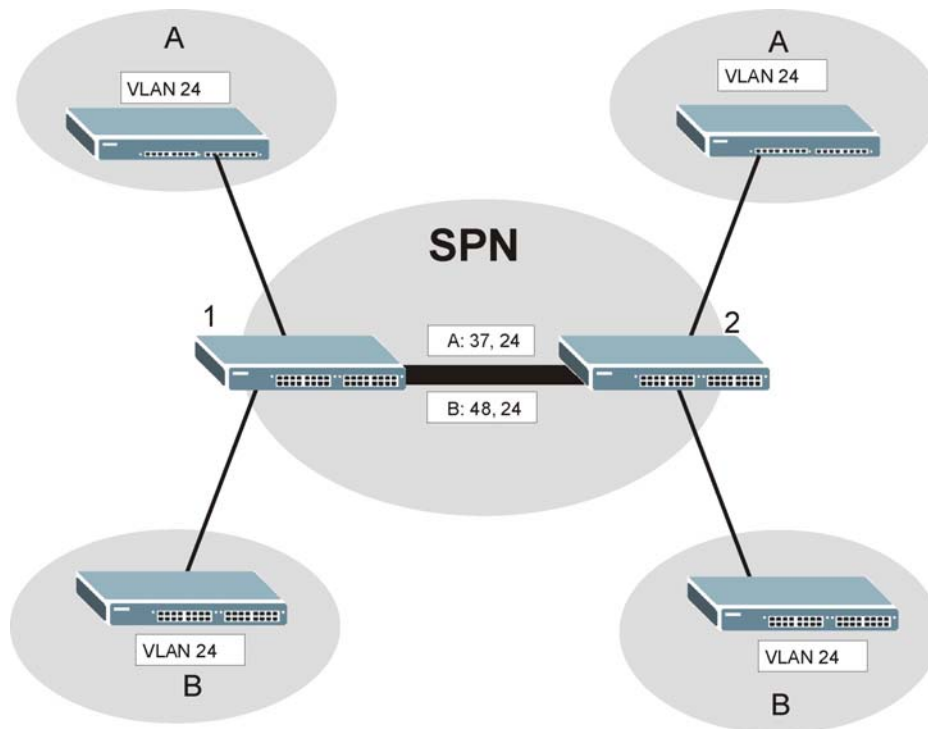

Figure 21-1 VLAN Stacking Example

21.2 VLAN Stacking Roles

Each port can have three VLAN stacking “roles”, **Normal**, **Access Port** and **Tunnel Port** (the latter is for Gigabit ports only).

- Select **Normal** for “regular” (non-VLAN stacking) IEEE 802.1Q frame switching.
- Select **Access Port** for ingress ports on the service provider's edge devices (1 and 2 in the VLAN stacking example figure). The incoming frame is treated as "untagged", so a second VLAN tag (outer VLAN tag) can be added.

Static VLAN Tx Tagging MUST be disabled on a port where you choose Normal or Access Port.

- Select **Tunnel** (available for Gigabit ports only) for egress ports at the edge of the service provider's network. All VLANs belonging to a customer can be aggregated into a single service provider's VLAN (using the outer VLAN tag defined by SP VID).

Static VLAN Tx Tagging MUST be enabled on a port where you choose Tunnel Port.

21.3 VLAN Tag Format

A VLAN tag (service provider VLAN stacking or customer IEEE 802.1Q) consists of the following three fields.

Type	Priority	VID
------	----------	-----

Type is a standard Ethernet type code identifying the frame and indicates that whether the frame carries IEEE 802.1Q tag information. **SP TPID** (Service Provider Tag Protocol Identifier) is the service provider VLAN stacking tag type. Many vendors use 0x8100 or 0x9100.

TPID (Tag Protocol Identifier) is the customer IEEE 802.1Q tag.

- If the VLAN stacking port role is **Access Port**, then the ES-3124 adds the **SP TPID** tag to all incoming frames on the service provider's edge devices (1 and 2 in the VLAN stacking example figure).
- If the VLAN stacking port role is **Tunnel**, then the ES-3124 only adds the **SP TPID** tag to all incoming frames on the service provider's edge devices (1 and 2 in the VLAN stacking example figure) that have an **SP TPID** different to the one configured on the ES-3124. (If an incoming frame's **SP TPID** is the same as the one configured on the ES-3124, then the ES-3124 will not add the tag.)

VID is the VLAN ID. **SP VID** is the VID for the second (service provider's) VLAN tag.

Priority refers to the IEEE 802.1p standard that allows the service provider to prioritize traffic based on the class of service (CoS) the customer has paid for.

On the ES-3124, configure priority level of inner IEEE 802.1Q tag in the **Port Setup** screen.

"0" is the lowest priority level and "7" is the highest.

21.3.1 Frame Format

The frame format for an untagged Ethernet frame, a single-tagged 802.1Q frame (customer) and a "double-tagged" 802.1Q frame (service provider) is shown next.

Configure the fields as circled in the ES-3124 **VLAN Stacking** screen.

						DA	SA	Len/Etype	Data	FCS	Untagged Ethernet frame
			DA	SA	TPID	Priority	VID	Len/Etype	Data	FCS	IEEE 802.1Q customer tagged frame
DA	SA	SPTPID	Priority	VID	TPID	Priority	VID	Len/Etype	Data	FCS	Double-tagged frame

DA	Destination Address	Priority	802.1p Priority
SA	Source Address	Len/Etype	Length and type of Ethernet frame
(SP)TPID	(Service Provider) Tag Protocol Identifier	Data	Frame data
VID	VLAN ID	FCS	Frame Check Sequence

21.4 Configuring VLAN Stacking

Click **Advanced Applications** and then **VLAN Stacking** in the navigation panel to display the screen as shown.

VLAN Stacking

Active

SP TPID 0x8100 Others (Hex)

Port	Role	SPVID	Priority
1	Normal	1	0
2	Normal	1	0
3	Normal	1	0
4	Normal	1	0
5	Normal	1	0
6	Normal	1	0
7	Normal	1	0
8	Normal	1	0
9	Normal	1	0
10	Normal	1	0
11	Normal	1	0
12	Normal	1	0
13	Normal	1	0
14	Normal	1	0
15	Normal	1	0
16	Normal	1	0
17	Normal	1	0
18	Normal	1	0
19	Normal	1	0
20	Normal	1	0
21	Normal	1	0
22	Normal	1	0
23	Normal	1	0
24	Normal	1	0
25	Normal	1	0
26	Normal	1	0
27	Normal	1	0
28	Normal	1	0

Apply Cancel

Figure 21-2 VLAN Stacking

The following table describes the labels in this screen.

Table 21-1 VLAN Stacking

LABEL	DESCRIPTION
Active	Select this checkbox to enable VLAN stacking on the switch.

Table 21-1 VLAN Stacking

LABEL	DESCRIPTION
SP TPID	SP TPID is a standard Ethernet type code identifying the frame and indicates whether the frame carries IEEE 802.1Q tag information. Choose 0x8100 or 0x9100 from the drop-down list box or select Others and then enter a four-digit hexadecimal number from 0x0000 to 0xFFFF. 0x denotes a hexadecimal number. It does not have to be typed in the Others text field.
Port	The port number identifies the port you are configuring.
Role	<p>Select Normal to have the switch ignore frames received (or transmitted) on this port with VLAN stacking tags. Anything you configure in SPVID and Priority are ignored.</p> <p>Select Access Port to have the ES-3124 add the SP TPID tag to all incoming frames received on this port. Select Access Port for ingress ports at the edge of the service provider's network.</p> <p>Select Tunnel Port (available for Gigabit ports only) for egress ports at the edge of the service provider's network.</p> <p>In order to support VLAN stacking on a port, the port must be able to allow frames of 1526 Bytes (1522 Bytes + 4 Bytes for the second tag) to pass through it.</p>
SPVID	SPVID is the service provider's VLAN ID (the outer VLAN tag). Enter the service provider ID (from 1 to 4094) for frames received on this port. See the chapter on VLANs for more background information on VLAN ID.
Priority	On the ES-3124, configure priority level of inner IEEE 802.1Q tag in the Port Setup screen. "0" is the lowest priority level and "7" is the highest.
Apply	Click Apply to save your changes back to the switch.
Cancel	Click Cancel to begin configuring this screen afresh.

Part VI

Routing Protocol and Management

This part describes the **Routing Protocol** and **Management** screens.

Chapter 22

Routing Protocol

This chapter shows you how to configure the routing functions.

22.1 Static Route

Static routes tell the ES-3124 how to forward IP traffic when you configure the TCP/IP parameters manually.

Click **Routing Protocol** in the navigation panel and then **Static Routing** to display the screen as shown.

Index	Active	Name	Destination Address	Subnet Mask	Gateway Address	Metric	Delete
1	Yes	ju	172.16.1.2	255.255.0.0	192.168.1.2	2	<input type="checkbox"/>

Figure 22-1 Static Routing

The following table describes the related labels you use to create a static route.

Table 22-1 Static Routing

LABEL	DESCRIPTION
Active	This field allows you to activate/deactivate this static route.
Name	Enter a descriptive name for this route. This is for identification purpose only.
Destination IP Address	This parameter specifies the IP network address of the final destination. Routing is always based on network number. If you need to specify a route to a single host, use a subnet mask of 255.255.255.255 in the subnet mask field to force the network number to be identical to the host ID.

Table 22-1 Static Routing

LABEL	DESCRIPTION
IP Subnet Mask	Enter the subnet mask for this destination.
Gateway IP Address	Enter the IP address of the gateway. The gateway is an immediate neighbor of your switch that will forward the packet to the destination. The gateway must be a router on the same segment as your switch.
Metric	The metric represents the “cost” of transmission for routing purposes. IP routing uses hop count as the measurement of cost, with a minimum of 1 for directly connected networks. Enter a number that approximates the cost for this link. The number need not be precise, but it must be between 1 and 15. In practice, 2 or 3 is usually a good number.
Add	Click Add to save the new rule to the switch. It then displays in the summary table at the bottom of the screen.
Cancel	Click Cancel to reset the fields to your previous configuration.
Clear	Click Clear to clear the fields to the factory defaults.

View the current static routes on the switch in the summary table at the bottom of the screen.

Index	Active	Name	Destination Address	Subnet Mask	Gateway Address	Metric	Delete
1	Yes	ju	172.16.1.2	255.255.0.0	192.168.1.2	2	<input type="checkbox"/>

Delete Cancel

Figure 22-2 Static Routing: Summary Table

The following table describes the labels in the summary table.

Table 22-2 Static Routing: Summary Table

LABEL	DESCRIPTION
Index	This field displays the index number of the route. Click a number to edit the static route entry.
Active	This field displays Yes when the static route is activated and NO when is it deactivated.
Name	This field displays the descriptive name for this route. This is for identification purpose only.
Destination Address	This field displays the IP network address of the final destination.
Subnet Mask	This field displays the subnet mask for this destination.
Gateway Address	This field displays the IP address of the gateway. The gateway is an immediate neighbor of your switch that will forward the packet to the destination.
Metric	This field displays the cost of transmission for routing purposes.

Table 22-2 Static Routing: Summary Table

LABEL	DESCRIPTION
Delete	Check the rule(s) that you want to remove in the Delete column, and then click the Delete button.
Cancel	Click Cancel to clear the selected checkboxes in the Delete column.

Chapter 23

Maintenance

This chapter explains how to configure the maintenance screens. The links on the upper right of the Maintenance screen lead to different screens that let you maintain the firmware and configuration files.

23.1 Maintenance

Click **Management** and then **Maintenance** in the navigation panel to open the following screen.



Figure 23-1 Maintenance

23.2 Firmware Upgrade

Click **Firmware Upgrade** in the **Maintenance** screen if you want to upgrade your switch firmware. See the **System Info** screen to verify your current firmware version number. Make sure you have downloaded (and unzipped) the correct model firmware and version to your computer before uploading to the device.

Be sure to upload the correct model firmware as uploading the wrong model firmware may damage your device.

From the **Maintenance** screen, display the **Firmware Upgrade** screen as shown next.

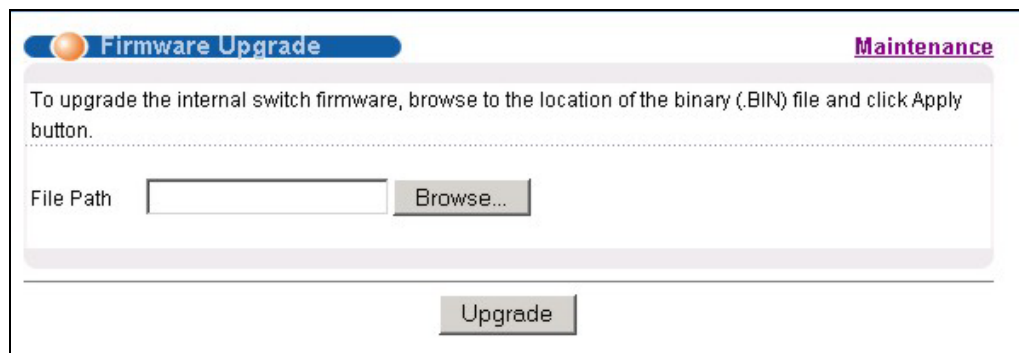
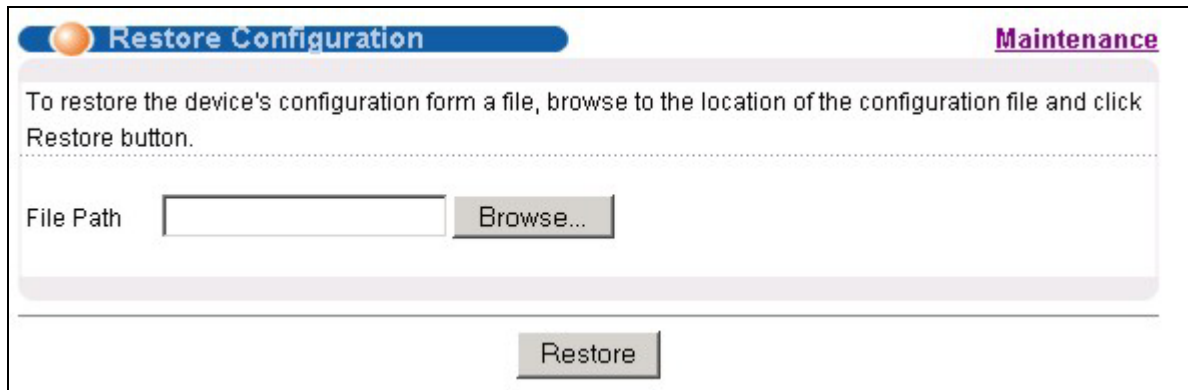

Figure 23-2 Firmware Upgrade

Type the path and file name of the firmware file you wish to upload to the switch in the **File Path** text box or click **Browse** to locate it. After you have specified the file, click **Upgrade**.

23.3 Restore a Configuration File

Restore a previously saved configuration from your computer to the switch using the **Restore Configuration** screen.



The screenshot shows a web interface for restoring a configuration. At the top, there is a blue header with an orange circle icon, the text 'Restore Configuration', and a purple 'Maintenance' link. Below the header, a light gray box contains the instruction: 'To restore the device's configuration form a file, browse to the location of the configuration file and click Restore button.' Underneath this instruction is a 'File Path' label followed by an empty text input field and a 'Browse...' button. At the bottom center of the main content area is a 'Restore' button.

Figure 23-3 Restore Configuration

Type the path and file name of the configuration file you wish to restore in the **File Path** text box or click **Browse** to display a **Choose File** screen from which you can locate it. After you have specified the file, click **Restore**. "rom-0" is the name of the configuration file on the switch, so your backup configuration file is automatically renamed when you restore using this screen.

23.4 Backing Up a Configuration File

Backing up your switch configurations allows you to create various “snap shots” of your device from which you may restore at a later date.

Back up your current switch configuration to a computer using the **Configuration Backup** screen.

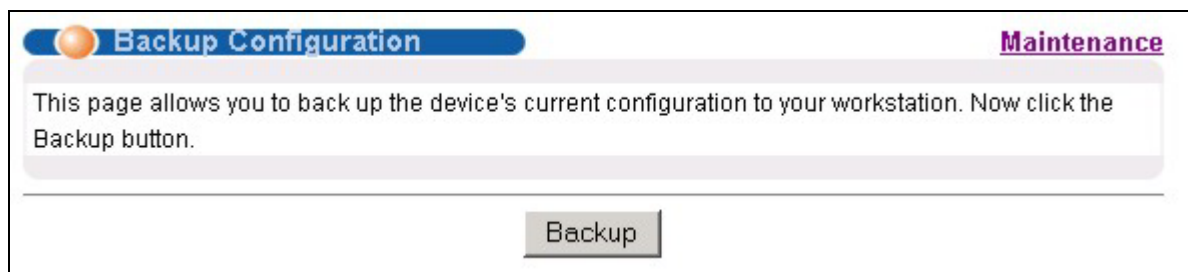

The screenshot shows a web interface for backing up a configuration. At the top, there is a blue header with an orange circle icon, the text 'Backup Configuration', and a purple 'Maintenance' link. Below the header, a light gray box contains the instruction: 'This page allows you to back up the device's current configuration to your workstation. Now click the Backup button.' At the bottom center of the main content area is a 'Backup' button.

Figure 23-4 Backup Configuration

Follow the steps below to back up the current switch configuration to your computer in this screen.

Step 1. Click **Backup**.

Step 2. Click **Save** to display the **Save As** screen.

Step 3. Choose a location to save the file on your computer from the **Save in** drop-down list box and type a descriptive name for it in the **File name** list box. Click **Save** to save the configuration file to your computer.

23.5 Load Factory Defaults

Press the **Click Here** button next to **Load Factory Defaults** to clear all switch configuration information you configured and return to the factory defaults. The following message appears.

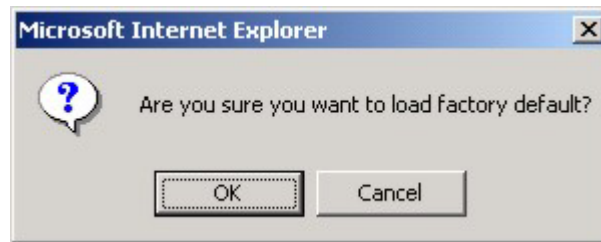

Figure 23-5 Confirm Load factory Defaults

Click **OK** to go to the next screen.

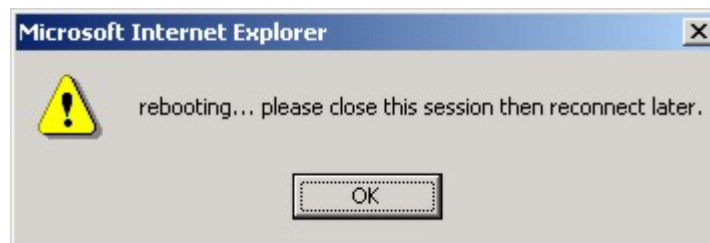

Figure 23-6 Restart Switch After Load Factory Defaults

Click **OK** to begin resetting all switch configurations to the factory defaults and then wait for the switch to restart. This takes up to two minutes. If you want to access the switch web configurator again, you may need to change the IP address of your computer to be in the same subnet as that of the default switch IP address (192.168.1.1).

23.6 Reboot System

Reboot System allows you to restart the switch without physically turning the power off. Press the **Click Here** button next to **Reboot System** to display the next screen.



Figure 23-7 Confirm Restart The Switch

Click **OK** to see the screen as shown in *Figure 23-6*. Click **OK** again and then wait for the switch to restart. This takes up to two minutes. This does not affect the switch's configuration.

23.7 Command Line FTP

This section shows some examples of uploading to or downloading files from the switch using FTP commands. First, understand the filename conventions.

23.7.1 Filename Conventions

The configuration file (often called the romfile or rom-0) contains the factory default settings in the screens such as password, switch setup, IP Setup, etc. It arrives from ZyXEL with a "rom" filename extension. Once you have customized the switch's settings, they can be saved back to your computer under a filename of your choosing.

ZyNOS (ZyXEL Network Operating System sometimes referred to as the "ras" file) is the system firmware and has a "bin" filename extension.

Table 23-1 Filename Conventions

FILE TYPE	INTERNAL NAME	EXTERNAL NAME	DESCRIPTION
Configuration File	Rom-0	*.rom	This is the configuration filename on the switch. Uploading the rom-0 file replaces the entire ROM file system, including your switch configurations, system-related data (including the default password), the error log and the trace log.
Firmware	Ras	*.bin	This is the generic name for the OS firmware on the switch.

Example FTP Commands

```
ftp> put firmware.bin ras
```

This is a sample FTP session showing the transfer of the computer file " firmware.bin" to the switch .

```
ftp> get rom-0 config.cfg
```

This is a sample FTP session saving the current configuration to a file called "config.cfg" on your computer.

If your (T)FTP client does not allow you to have a destination filename different than the source, you will need to rename them as the switch only recognizes "rom-0" and "ras". Be sure you keep unaltered copies of both files for later use.

Be sure to upload the correct model firmware as uploading the wrong model firmware may damage your device.

23.7.2 FTP Command Line Procedure

Step 1. Launch the FTP client on your computer.

Step 2. Enter "open", followed by a space and the IP address of your switch.

Step 3. Press [ENTER] when prompted for a username.

Step 4. Enter your password as requested (the default is “1234”).

Step 5. Enter “bin” to set transfer mode to binary.

Step 6. Use “put” to transfer files from the computer to the switch, for example, “put firmware.bin ras” transfers the firmware on your computer (firmware.bin) to the switch and renames it “ras”. Similarly, “put config.rom rom-0” transfers the configuration file on your computer (config.rom) to the switch and renames it “rom-0”. Likewise “get rom-0 config.rom” transfers the configuration file on the switch to your computer and renames it “config.rom.” See earlier in this chapter for more information on filename conventions.

Step 7. Enter “quit” to exit the ftp prompt.

23.7.3 GUI-based FTP Clients

The following table describes some of the commands that you may see in GUI-based FTP clients.

Table 23-2 General Commands for GUI-based FTP Clients

COMMAND	DESCRIPTION
Host Address	Enter the address of the host server.
Login Type	Anonymous. This is when a user I.D. and password is automatically supplied to the server for anonymous access. Anonymous logins will work only if your ISP or service administrator has enabled this option. Normal. The server requires a unique User ID and Password to login.
Transfer Type	Transfer files in either ASCII (plain text format) or in binary mode. Configuration and firmware files should be transferred in binary mode.
Initial Remote Directory	Specify the default remote directory (path).
Initial Local Directory	Specify the default local directory (path).

23.7.4 FTP over WAN Restrictions

FTP over WAN will not work when:

- Telnet service is disabled in **Secured Client Sets**.
- The IP address(es) in the **Secured Client Sets** menu does not match the client IP address. If it does not match, the switch will disconnect the Telnet session immediately.

Chapter 24

Diagnostic

This chapter explains the Diagnostic screens.

24.1 Diagnostic

Click **Management** and then **Diagnostic** in the navigation panel to display this screen. Use this screen to check system logs, ping IP addresses or perform loopback tests on a port.

The screenshot shows the 'Diagnostic' screen with a blue header bar containing an orange circle icon and the word 'Diagnostic'. Below the header is a large multi-line text box with a vertical scrollbar on the right, containing the text '- Info -'. Below the text box is a horizontal line. Underneath the line are three sections for diagnostic tests:

- System Log:** Includes a 'Display' button and a 'Clear' button.
- IP Ping:** Includes a text input field for 'IP Address' and a 'Ping' button.
- Ethernet Port Test:** Includes a 'Port' dropdown menu currently showing '1' and a 'Port Test' button.

Figure 24-1 Diagnostic

The following table describes the labels in this screen.

Table 24-1 Diagnostic

LABEL	DESCRIPTION
System Log	Click Display to display a log of events in the multi-line text box. Click Clear to empty the text box and reset the syslog entry.

Table 24-1 Diagnostic

LABEL	DESCRIPTION
IP Ping	Type the IP address of a device that you want to ping in order to test a connection. Click Ping to have the switch ping the IP address (in the field to the left).
Ethernet Port Test	From the Port drop-down list box, select a port number and click Port Test to perform internal loopback test.

Chapter 25

Cluster Management

This chapter introduces cluster management.

25.1 Introduction to Cluster Management

Cluster Management allows you to manage switches through one switch, called the cluster manager. The switches must be directly connected and be in the same VLAN group so as to be able to communicate with one another.

Table 25-1 Clustering Management Specifications

Maximum number of cluster members	24
Cluster Member Models	Must be compatible with ZyXEL cluster management implementation.
Cluster Manager	The switch through which you manage the cluster member switches.
Cluster Members	The switches being managed by the cluster manager switch.

In the following example, switch A in the basement is the cluster manager and the other switches on the upper floors of the building are cluster members.

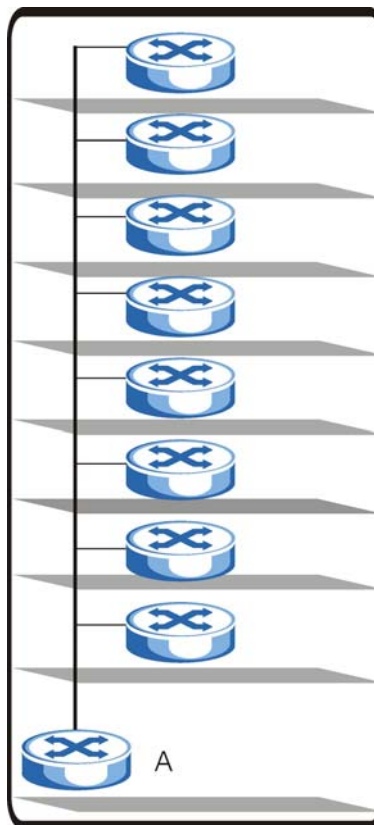

Figure 25-1 Clustering Application Example

25.2 Cluster Management Status

Click **Management** in the navigation panel and then **Cluster Management** to display the following screen.

Clustering Management Status		Configuration		
Status	Manager			
Manager	00:a0:c5:00:00:01			
The Number Of Member = 1				
Index	MacAddr	Name	Model	Status
1	00:a0:c5:01:23:46	ES-3124	ES-3124	Online

Figure 25-2 Cluster Management Status

The following table describes the labels in this screen.

Table 25-2 Cluster Management Status

LABEL	DESCRIPTION
A cluster can only have one manager.	
Status	This field displays the role of this switch within the cluster. <ul style="list-style-type: none"> o Manager o Member (you see this if you access this screen in the cluster member switch directly and not via the cluster manager) o None (neither a manager nor a member of a cluster)
Manager	This field displays the cluster manager switch's hardware MAC Address.
The Number of Member	This field displays the number of switches that make up this cluster. The following fields describe the cluster member switches.
Index	You can manage cluster member switches via the cluster manager switch. Each number in the Index column is a hyperlink leading to the cluster member switch's web configurator (see <i>Figure 25-3</i>).
MacAddr	This is the cluster member switch's hardware MAC Address.
Name	This is the cluster member switch's System Name .
Model	This field displays the model name.

Table 25-2 Cluster Management Status

LABEL	DESCRIPTION
Status	This field displays: <ul style="list-style-type: none"> o Online (the cluster member switch is accessible) o Error (for example the cluster member switch password was changed or the switch was set as the manager and so left the member list, etc.) o Offline (the switch is disconnected - Offline shows approximately 1.5 minutes after the link between cluster member and manager goes down).

25.2.1 Cluster Member Switch Management

Go to the **Clustering Management Status** screen of the cluster manager switch and then select an **Index** hyperlink from the list of members to go to that cluster member switch's web configurator home page. This cluster member web configurator home page and the home page that you'd see if you accessed it directly are different (see *Figure 25-3*).

**Figure 25-3 Cluster Member Web Configurator Screen**

Uploading Firmware to a Cluster Member Switch

You can use FTP to upload firmware to a cluster member switch through the cluster manager switch as shown in the following example.

```

C:\> ftp <Cluster Manager IP address>
Connected to 192.168.1.1.
220 ES-3124 FTP version 1.0 ready at Thu Jan 1 00:06:58 1970
User (192.168.1.1:(none)): admin
331 Enter PASS command
Password:
230 Logged in
ftp> ls
200 Port command okay
150 Opening data connection for LIST
--w--w--w- 1 owner  group      2092320 Jul 01 12:00 ras
-rw-rw-rw- 1 owner  group      393216 Jul 01 12:00 rom-0
--w--w--w- 1 owner  group           0 Jul 01 12:00 fw-00-a0-c5-01-23-46
-rw-rw-rw- 1 owner  group           0 Jul 01 12:00 config-00-a0-c5-01-23-46
226 File sent OK
ftp: 296 bytes received in 0.01Seconds 19.73Kbytes/sec.
ftp> put 350TP0b1.bin fw-00-a0-c5-01-23-46
ftp> bye

```

Figure 25-4 Example: Uploading Firmware to a Cluster Member Switch

The following table explains some of the FTP parameters.

Table 25-3 FTP Upload to Cluster member Example

FTP PARAMETER	DESCRIPTION
User name	The default user name is admin .
Password	The web configurator password default is 1234 .
ls	Enter this command to list the name of cluster member switch's firmware and configuration file.
fw-00-a0-c5-01-23-46	The cluster member switch's firmware name as seen in the cluster manager switch.
config-00-a0-c5-01-23-46	The cluster member switch's configuration file name as seen in the cluster manager switch.
350TP0b1.bin	The name of the firmware file you want to upload to the cluster member switch.

25.3 Configuring Cluster Management

Click **Configuration** from the **Cluster Management** screen to display the next screen.

Clustering Management Configuration
Status

Clustering Manager:

Active	<input checked="" type="checkbox"/>
Name	<input type="text" value="cluster"/>
VID	1

Clustering Candidate:

List	00:a0:c5:01:23:46/ES-3124/ES-3124
Password	<input type="password" value="****"/>

Index	MacAddr	Name	Model	Remove

Figure 25-5 Configuring Cluster Management

The following table describes the labels in this screen.

Table 25-4 Configuring Cluster Management

LABEL	DESCRIPTION
Active	Select Active to have this switch become the cluster manager switch. A cluster can only have one manager. Other (directly connected) switches that are set to be cluster managers will not be visible in the Clustering Candidates list. If a switch that was previously a cluster member is later set to become a cluster manager, then its Status is displayed as Error in the Cluster Management Status screen and a warning icon () appears in the member summary list below.
Name	Type a name to identify the Clustering Manager . You may use up to 32 printable characters (no spaces are allowed).

Table 25-4 Configuring Cluster Management

LABEL	DESCRIPTION
VID	This is the Management VLAN ID and is only applicable if the switch is set to 802.1Q VLAN. All switches must be in the same management VLAN group to belong to the same cluster. Switches that are not in the same management VLAN group are not visible in the Clustering Candidates list. This field is ignored if the Clustering Manager is using Port-based VLAN.
Apply	Click Apply to save these changes to the switch.
Cancel	Click Cancel to begin configuring this part of the screen afresh.
Clustering Candidate	The following fields relate to the switches that are potential cluster members.
List	A list of suitable candidates found by auto-discovery is shown here. The switches must be directly connected. Directly connected switches that are set to be cluster managers will not be visible in the Clustering Candidate list. Switches that are not in the same management VLAN group will not be visible in the Clustering Candidate list.
Password	<p>Each cluster member's password is its web configurator password. Select a member in the Clustering Candidate list and then enter its web configurator password. If that switch administrator changes the web configurator password afterwards, then it cannot be managed from the Cluster Manager. Its Status is displayed as Error in the Cluster Management Status screen and a warning icon () appears in the member summary list below.</p> <p>If multiple devices have the same password then hold [SHIFT] and click those switches to select them. Then enter their common web configurator password.</p>
Add	Click Add to save these changes to the switch.
Cancel	Click Cancel to begin configuring this part of the screen afresh.
Refresh	Click Refresh to perform auto-discovery again to list potential cluster members.
The next summary table shows the devices selected for clustering.	
Index	This is the index number of a cluster member switch.
MacAddr	This is the cluster member switch's hardware MAC address.
Name	This is the cluster member switch's System Name .
Model	This is the cluster member switch's model name.
Remove	Select this checkbox and then click the Remove button to remove a cluster member switch from the cluster.
Cancel	Click Cancel to begin configuring this part of the screen afresh.

Chapter 26

MAC Table

This chapter introduces MAC Table.

26.1 Introduction to MAC Table

The MAC table shows how frames are forwarded or filtered across the switch's ports. It shows what device MAC address, belonging to what VLAN group (if any) is forwarded to which port(s) and whether the MAC address is dynamic (learned by the switch) or static (manually entered in **Static MAC Forwarding**).

The switch uses the Filtering Database to determine how to forward frames. See the following figure.

1. The switch examines a received frame and learns the port on which this source MAC address came.
2. The switch checks to see if the frame's destination MAC address matches a source MAC address already learned in the Filtering Database.
 - If the switch has already learned the port for this MAC address, then it forwards the frame to that port.
 - If the switch has not already learned the port for this MAC address, then the frame is flooded to all ports. Too much port flooding leads to network congestion.
 - If the switch has already learned the port for this MAC address, but the destination port is the same as the port it came in on, then it filters the frame.

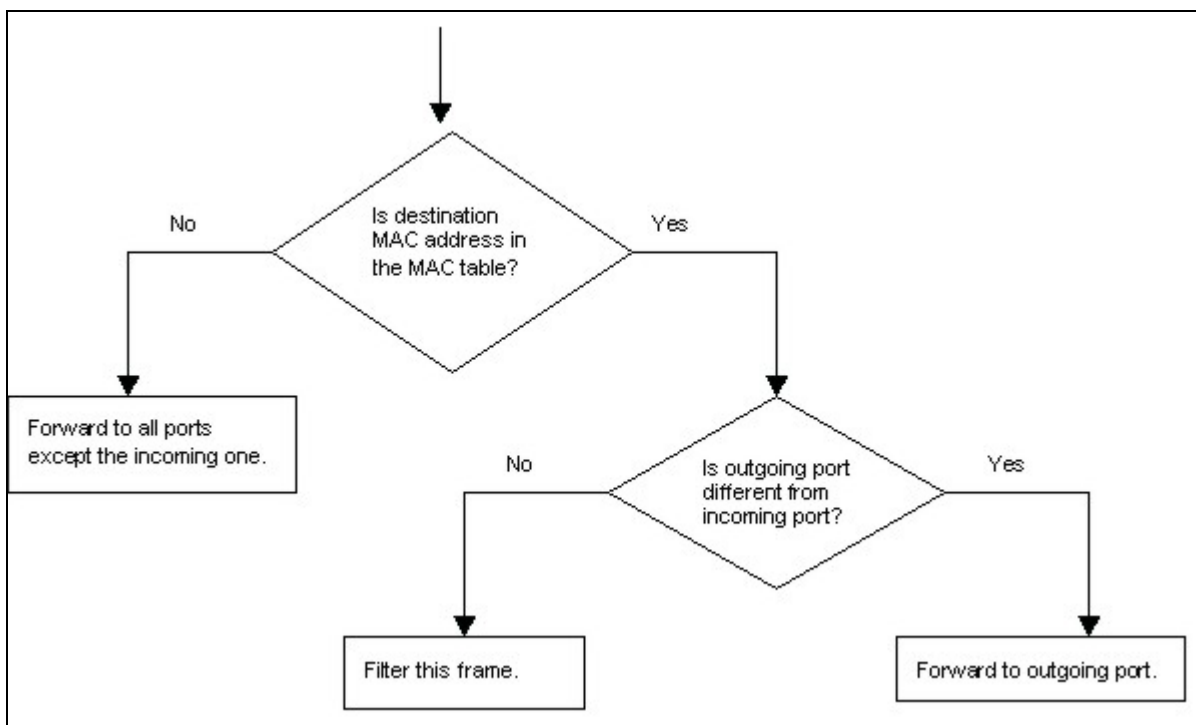

Figure 26-1 MAC Table Flowchart

26.2 Viewing MAC Table

Click **Management** in the navigation panel and then **MAC Table** to display the following screen. The MAC Table can hold up to 16K entries.

The screenshot shows a web interface titled "MAC Table". At the top, there is a "Sort by" section with three buttons: "MAC", "VID", and "Port". Below this is a table with the following data:

Index	MAC Address	VID	Port	Type
1	00:a0:c5:00:01:27	1	1	dynamic
2	00:a0:c5:01:23:45	2	1	dynamic
3	00:a0:c5:02:35:7e	3	1	dynamic
4	0a:b2:a0:81:f3:7e	1	1	static
5	00:00:e8:7c:14:80	1	28	dynamic

Figure 26-2 MAC Table

The following table describes the labels in this screen.

Table 26-1 MAC Table

LABEL	DESCRIPTION
Sort by	Click one of the following buttons to display and arrange the data according to that button type. The information is then displayed in the summary table below.
MAC	Click this button to display and arrange the data according to MAC address.
VID	Click this button to display and arrange the data according to VLAN group.
Port	Click this button to display and arrange the data according to port number.
Index	This is the incoming frame index number.
MAC Address	This is the MAC address of the device from which this incoming frame came.
VID	This is the VLAN group to which this frame belongs.
Port	This is the port from which the above MAC address was learned.
Type	This shows whether the MAC address is dynamic (learned by the switch) or static (manually entered in Static MAC Forwarding).

Chapter 27

ARP Table

This chapter introduces ARP Table.

27.1 Introduction to ARP Table

Address Resolution Protocol (ARP) is a protocol for mapping an Internet Protocol address (IP address) to a physical machine address, also known as a Media Access Control or MAC address, on the local area network.

An IP (version 4) address is 32 bits long. In an Ethernet LAN, MAC addresses are 48 bits long. The ARP Table maintains an association between each MAC address and its corresponding IP address.

27.1.1 How ARP Works

When an incoming packet destined for a host device on a local area network arrives at the switch, the switch's ARP program looks in the ARP Table and, if it finds the address, sends it to the device.

If no entry is found for the IP address, ARP broadcasts the request to all the devices on the LAN. The switch fills in its own MAC and IP address in the sender address fields, and puts the known IP address of the target in the target IP address field. In addition, the switch puts all ones in the target MAC field (FF.FF.FF.FF.FF.FF is the Ethernet broadcast address). The replying device (which is either the IP address of the device being sought or the router that knows the way) replaces the broadcast address with the target's MAC address, swaps the sender and target pairs, and unicasts the answer directly back to the requesting machine. ARP updates the ARP Table for future reference and then sends the packet to the MAC address that replied.

27.2 Viewing ARP Table

Click **Management** in the navigation panel and then **ARP Table** to open the following screen. The ARP table can hold up to 500 entries.

ARP Table			
Index	IP Address	MAC Address	Type
1	127.0.0.101	00:a0:c5:32:71:95	dynamic
2	127.0.0.102	00:a0:c5:32:71:97	dynamic
3	127.0.0.103	00:a0:c5:61:28:92	dynamic
4	127.0.0.104	00:a0:c5:ff:12:6c	dynamic
5	127.0.0.105	00:a0:c5:4b:d6:67	dynamic
6	169.254.170.66	00:0b:cd:94:85:00	dynamic
7	172.17.2.1	00:60:b0:d6:e1:ad	dynamic
8	172.17.2.4	00:01:e6:61:26:d4	dynamic
9	172.17.2.6	00:10:83:95:30:a1	dynamic
10	172.17.2.254	00:01:30:b8:16:40	dynamic
11	172.21.0.2	00:05:5d:04:30:f1	dynamic
12	172.21.0.254	00:01:30:b8:16:40	dynamic
13	172.21.1.166	00:02:b3:2c:79:93	dynamic
14	172.21.2.229	00:50:8d:36:37:e2	dynamic
15	172.21.3.6	00:50:8d:36:3c:3b	dynamic
16	172.21.3.7	00:50:ba:ad:75:dd	dynamic
17	172.21.3.11	00:50:8d:af:13:31	dynamic
18	172.21.3.15	00:00:e8:89:88:06	dynamic
19	172.21.3.18	00:50:8d:af:2f:28	dynamic
20	172.21.3.19	00:a0:c5:01:23:46	dynamic
21	172.21.3.20	08:00:46:68:10:58	dynamic
22	172.21.3.21	00:0b:cd:94:89:32	dynamic
23	172.21.3.23	00:00:e2:93:68:06	dynamic
24	172.21.3.25	00:05:5d:e1:6c:cb	dynamic

Figure 27-1 ARP Table

The following table describes the labels in this screen.

Table 27-1 ARP Table

LABEL	DESCRIPTION
Index	This is the ARP Table entry number.
IP Address	This is the learned IP address of a device connected to a switch port with corresponding MAC address below.
MAC Address	This is the MAC address of the device with corresponding IP address above.
Type	This shows whether the MAC address is dynamic (learned by the switch) or static (manually entered in Static MAC Forwarding).

Part VII

Commands

This part gives information on Command Line Interface (CLI) commands for the ES-3124.

Chapter 28

Introduction to CLI

This chapter introduces line commands and gives a summary of commands available.

28.1 Command Line Interface Overview

In addition to the web configurator, you can use line commands to configure the switch. It is recommended that you use the web configurator for everyday management of the switch and that you use line commands for advanced switch diagnosis and troubleshooting. If you have problems with your switch, customer support may request that you issue some of these commands to assist them in troubleshooting.

You can use the “config save” command to save 802.1Q, STP, VLAN Stacking, Cluster and IP configuration changes to non-volatile memory (Flash). These changes are effective after you restart the switch.

However you cannot use “config save” for all other line command configurations. These are saved in volatile memory (DRAM), so are not effective after you restart the switch.

28.1.1 Accessing the Command Line Interface

There are two ways to access the command line interface on the ES-3124:

- Telnet to the switch
- Connect a computer to the console port and use terminal emulation software configured to the following parameters:
 - VT100 terminal emulation
 - 9600 bps
 - No parity, 8 data bits, 1 stop bit
 - No flow control

28.1.2 Command Conventions

The system uses a one-level command structure. You must type the full command every time, as follows.

```
ES-3124> <command>
```

For instance, the following example shows how to enable GVRP.

```
ES-3124> sys sw gvrp enable
```

The conventions for typing in most CI commands are shown next.

```
command <interface|device> subcommand [parameter]
```

```
command subcommand [parameter]
```

Type all commands as displayed on the screen.

28.1.3 Command Syntax Conventions

1. Command keywords are in `courier new` font.
2. The `|` symbol means “or”.
3. Required fields in a command are enclosed in angle brackets `<>`. Use the following command to turn the system monitor on or off.

```
sys monitor enable <on/off>
```

4. Optional fields in a command are enclosed in square brackets `[]`, for example, year, month and day are optional in the following command. This command just displays the date if you don’t specify the year, month and day parameters.

```
sys date [year month day]
```

5. Commands can be abbreviated to the smallest unique string that differentiates the command. For example the “system date” command could be abbreviated to “s d”.

28.1.4 Getting Help

Type “help” or “?” to display a list of valid commands or type a command followed by “help” or “?” to display a list of associated subcommands.

The following figure shows a sample help information.

```
Copyright (c) 1994 - 2004 ZyXEL Communications Corp.
ES-3124> ?
Valid commands are:
sys          exit          ether        config
ip
ES-3124> sys view
Usage: view <filename>
```

Figure 28-1 CLI Help: Sample Output

28.2 Command Summary

The following tables are summaries of the commands available in the ES-3124 together with a brief description of each command. See the related section in the *User’s Guide* for more background information.

28.2.1 sys Commands

Table 28-1 Command Summary: sys

COMMAND		DESCRIPTION
sys		

Table 28-1 Command Summary: sys

COMMAND		DESCRIPTION
adjtime		Retrieves the date and time from the time server specified in the web configurator.
countrycode	<country code>	Sets or displays the firmware country code.
cpu	display	Displays the CPU's utilization.
date	[year month day]	Sets or displays the system's current date.
domainname	[domain name]	Sets or displays the system domain name.
edit		Edits the system preset text file such as autoexec.net.
feature		Displays a list of the device's major features.
hostname	[hostname]	Sets or displays the system name.
log		
	clear	Clears the error log.
	disp	Shows the error log.
	online [on off]	Enables/disables the error log to be displayed on screen.
stdio	[minute]	Sets or displays the management terminal idle timeout value.
syslog	server	Set syslog server IP address
	facility	Set syslog facility
	type	Set/display syslog type flag
	mode	Set syslog mode
time	[hour [min [sec]]]	Sets or displays the system time.
trcdisp	parse, brief, disp	Sets the level of detail that should be displayed. Use "parse" to display the most detail and "disp" to display the least.
trclog		
	switch [on off]	Enables/disables the system trace log or shows whether it's on or off.
	online [on off]	Enables/disables the trace log onscreen display (for example in the telnet management window).
	level [level]	Sets the level (1-10) of trace logs (1 shows the least) to display.

Table 28-1 Command Summary: sys

COMMAND		DESCRIPTION
	type <bitmap>	Uses hexadecimal characters to set the type of trace logs to record.
	disp	Shows the trace log.
	clear	Erases the trace log.
	call	Shows call events.
	encapmask [mask]	Shows which type of encapsulation the trace log records or sets it if you specify the encapsulation's hexadecimal character.
	trcpacket	
	create <entry> <size>	Creates a packet trace buffer.
	destroy	Removes the packet trace buffer.
	channel <name> [none incoming outgoing bothway]	Sets the packet trace direction for a given channel.
	string [on off]	Enables/disables the sending of a log to the trace packet buffer when configuration changes are made or displays the current setting.
	switch [on off]	Enables/disables packet trace or displays the current setting.
	disp	Displays the trace packets.
	udp	Sends the trace packets to another system using UDP.
	udp switch [on off]	Enables/disables the sending of the trace packets to another system using UDP or displays the current setting.
	udp addr <addr>	Sets the target IP address for sending trace packets using UDP.
	udp port <port>	Sets the UDP port (should match that of the target IP address) for sending trace packets using UDP.
	parse [[start_idx], end_idx]	Displays detailed packet details of the packet range specified.
	brief	Displays a brief listing of packet contents.
	version	Displays the RAS code and driver versions.
	view <filename>	Displays the specified text file.
	wdog	
	switch [on off]	Turns the watchdog firmware protection feature on or off.

Table 28-1 Command Summary: sys

COMMAND			DESCRIPTION
		cnt [value]	Sets (0-34463) or displays the current watchdog count (in 1.6 sec units).
	monitor	status	Displays the status of the hardware monitor.
		show	Displays the hardware monitor's statistics.
		vlimit <idx> <high> <low>	Sets the maximum (<high>) or minimum (<low>) voltage at the specified point (<idx>).
		tlimit <idx> <limit>	Sets the maximum (<limit>) temperature at the specified point (<idx>).
		flimit <bank> <idx> [<limit>]	Sets the maximum (<limit>) fan revs per minute (RPM) at the specified fan (<idx>) in the specified bank (<bank>). A "bank" delineates a set of fans.
		fanmask <bank> [<mask>]	Sets the fan detection mask in the specified bank (<bank>). Use the mask to disable monitoring of a fan.
		vclear	Clears the voltage statistics.
		tclear	Clears the temperature statistics.
		fclear	Clears the fan statistics.
		clear	Clears the hardware monitor statistics.
		enable [<on/off>]	Enables or disables the hardware monitor.
		test	Tests the hardware monitor chip.
		addr	Displays the W83782D ISA bus address.
		hw-ver	Displays the hardware version ID.
	socket		Displays the system socket's ID #, type, control block address (PCB), IP address and port number of peer device connected to the socket (Remote Socket) and task control block (Owner).
	snmp	getCommunity <index> [<community>]	Sets or displays the SNMP GetRequest community.
		setCommunity <index> [<community>]	Sets or displays the SNMP SetRequest community.

Table 28-1 Command Summary: sys

COMMAND		DESCRIPTION
	trustedHost <index>[<hostt>]	Sets or displays the SNMP trusted host.
	trapCommunity <index> [<community>]	Sets or displays the SNMP Trap community.
	trapDest <index>[<destination>]	Sets or displays the SNMP trap server.
	disp <index all>	Shows SNMP settings.
cluster	active <name>	Assign a cluster name and enable clustering it.
	inactive <name>	Disable the cluster named.
	add <MAC addr> <password>	Add a member switch into the cluster using its web configurator password.
	remove <MAC addr>	Remove a member switch from the cluster.
	showMember	Shows details of member switches in this cluster.
	showCandidate	Shows a list of auto-discovered potential cluster members.
	status	Shows whether this switch is a cluster member, cluster manager or neither and information about members in the cluster.
	trace	Sets cluster management debug level.
	telnet <MAC>	Telnets to the specified host.

28.2.2 sys sw Commands

The following commands are system switch commands; all are preceded with `sys sw`.

Table 28-2 Command Summary: sys sw

COMMAND		DESCRIPTION
garp	status	Shows the GARP timer status.
	timer <join timer(ms)><leave timer(ms)><leave all timer<ms>	Sets the GARP timer's Join Timer, Leave Timer and Leave All Timer.
gvrp	trace	Sets GVRP trace level.
	enable	Enables GVRP.
	disable	Disables GVRP.
	status	Shows the GVRP status.

Table 28-2 Command Summary: sys sw

COMMAND			DESCRIPTION
qos	defpri	<port> [<0..7>]	Sets the default ingress User Priority for a port.
	map	<0..7> [<queue>]	Maps a user priority to a traffic class.
	method	<strict wfq>	Sets QoS method.
	weight	<port> wt1 wt2 wt3 wt4 wt5 wt6 wt7 wt8 (0<weight<16)	Shows the queue weight on the specified port.
vlan1q			All “sys sw vlan1q” commands relate to IEEE 802.1Q Tagged VLAN configuration. Use “config save” to save your configuration changes.
	port	status <port>	Shows a port’s VLAN information.
		defaultVID <port><vid>	Sets the default VLAN ID of a port.
		accept <port> <all tagged untagged>	Sets the type of frames that a port accepts.
		gvrp <port> <enable disable>	Enables/disables GVRP on the specified port.
		vlanTrunking <port> <enable disable>	Enables/disables VLAN trunking on the specified port.
	svlan	cpu <vlan id>	Sets the VLAN ID of the management VLAN (CPU).
		setentry<name><vid><port><adctl> <tagctl>	Applies a static VLAN (name, admin control tag, tag control) to a port.
		delentry <vid>	Deletes the specified (VID) static VLAN.
		active <vid>	Turns on the specified static VLAN.
		inactive <vid>	Turns off the specified static VLAN.
		list	Displays a table of static VLANs.
	vlan	list <all vid start_vid end_vid>	Shows the specified IEEE 802.1Q Tagged VLAN table.
	status		Shows the IEEE 802.1Q tagged status.
driver	config		Shows the switch’s settings.
	count	disp	Shows the switch Network Driver Interface Specifications (NDIS) level counters (CPU interface).

Table 28-2 Command Summary: sys sw

COMMAND			DESCRIPTION
		clear	Clears the switch NDIS level counters (CPU interface).
rstp			All "sys sw rstp" commands relate to rapid STP configuration. Refer to IEEE Std 802.1w. Use "config save" to save your configuration changes.
	bridge		
		enable	Enables RSTP.
		disable	Disables RSTP.
		priority <priority>	Sets the system priority.
		maxage <Max_Age>	Sets the max age timer
		hellotime <Hello_Time>	Sets the hello timer.
		forwardDelay <Forward_Delay_Time>	Sets the forward delay time
		version <STP:0 RSTP:2>	Displays/enables the STP mode; STP or RSTP. RSTP is the default used when configuring STP via web configurator.
	port		
		enable <port_no>	Enables RSTP on this port.
		disable <port_no>	Disables RSTP on this port.
		pathCost <Port_NO> <Cost 0:Auto>	Sets the specified port's path cost.
		priority <Port_NO> <Priority>	Sets the specified port's priority.
		edgeport <port_no>	Displays if this port is an edge port.
		p2pLink <Port_NO> <Auto:2 True:1 False:0>	Sets whether the specified port can connect to one bridge or multiple bridges.
		mcheck <Port_NO>	Enables the Port Protocol Migration state machine (Disabled, Blocking, Listening, Learning, Forwarding) on the specified port.
	disp		Displays RSTP status.
	trace		Sets RSTP debug level.
lACP			Refer to IEEE 802.3ad for more information on link aggregation control protocol.
	agg		Displays ports trunked using LACP.
	port		

Table 28-2 Command Summary: sys sw

COMMAND			DESCRIPTION
		enable <port_no>	Enables LACP on the specified port.
		disable <port_no>	Disables LACP on the specified port.
		status <port_no>	Displays whether LACP is enabled on the specified port.
		actorAdm activity [port_no] [0:passive 1:active]	Allows/disallows the specified local port to engage in trunking.
		actorAdm display [port_no]	Shows whether the specified local port is engaged in trunking.
		actorAdm key [port_no][key]	Shows the specified local port LACP key.
		actorAdm priority [port_no] [priority]	Sets the specified local port LACP priority.
		actorAdm timeout [port_no] [0:long_timeout 1:short_timeout]	Enables a short or long timeout on the specified local port.
	status	<Port_NO>	Displays LACP status on a port.
	keymgnt	[on off]	Turns LACP key management on or off.
	syspriority	<priority>	Sets the LACP system priority. The switch with the lowest priority becomes the LACP "server".
	trace		Sets the LACP debug level.
dot1x			"sys sw dot1x" commands relate to IEEE 802.1X security.
	enable		Enables 802.1X security on the switch.
	disable		Disables 802.1X security on the switch.
	status		Shows switch 802.1X security status.
	port		
		enable <port_no>	Enables 802.1X security on the specified port.
		disable <port_no>	Disables 802.1X security on the specified port.
		reauth <port_no> <on off>	Turns re-authentication on or off on the specified port.
		period <port_no><value>	Configures how often the specified port should be re-authenticated.

Table 28-2 Command Summary: sys sw

COMMAND		DESCRIPTION	
		status <port_no>	Displays 802.1X security status on the specified port.
	set		
		auth <profile radius>	Sets whether an external RADIUS server or the internal switch user database performs authentication.
		control<port-no><auto auth unauth>	Sets how the specified port should be authenticated.
		radius server <ip>	Sets the external RADIUS server IP address.
		radius secret <secret>	Sets the external RADIUS server password.
		radius port <port>	Sets the external RADIUS server port number.
		radius show	Displays the external RADIUS server settings.
		profile	Internal switch user database. Information in this database is flushed on restarting the switch.
		profile add <username> <passwd>	Creates a username and password profile in the internal switch user database.
		profile delete <idx>	Deletes a username and password profile in the internal switch user database.
		profile list	Lists all profiles in the internal switch user database.
classifier	add	<classifier name> [port <portnum>] [pktfmt <802.3 802.3tag etherII etherIItag>] [vid<vid>] [ethertype <ip ipx arp rarp appletalk decent sna netbios dlc ethernet>] [srcmac <macaddr>] [dstmac <macaddr>] [ipprotocol<tcp udp icmp egp ospf rsvp igmp igp pim ipsec ipprotocolnum>] [srcip <ipaddr> <maskbit>] [dstip <ipaddr> <maskbit>] [srcskt <socketnum>] [dstskt <socketnum>]	Add a new classifier.
	display		Displays the classifier summary table.
	del	<classifier name>	Removes a classifier.
	view	<classifier name>	Displays detail information of a classifier.

Table 28-2 Command Summary: sys sw

COMMAND			DESCRIPTION
bmstorm			These commands relate to broadcast storm control.
	disable		Turns off broadcast storm control.
	enable		Turns on broadcast storm control.
	port	<port> <type> <active(on off)> <threshold(pps)>	Sets broadcast storm control on a port for a specific packet type in packet per second (pps).
	display		Displays broadcast storm control ports' settings.
mac	static		Displays static MAC addresses.
		disable	Clears current run-time static MAC address settings
		display [<mac> <vid>]	Displays current run-time static MAC addresses on the ports.
		set <port> <MAC> <vid>	Configures a static MAC address on the specified port.
		del <port> <MAC> <vid>	Deletes a static MAC address on the specified port.
	ageSet	<timeout>	Sets aging timeout.
	ageView		Displays the aging timeout period.
	list		Displays the forwarding table entries.
	count		Displays the number of MAC addresses in the forwarding table.
	flush	Port <port>	Deletes learned MAC addresses on the specified port in the forwarding table.
		all	Deletes all learned MAC addresses in the forwarding table.
filter	l2addr	<enable> <mac><vid> <discardSrc> <discardDst>	The following command relates to port filters. Port filtering means sifting traffic based on the source and/or destination MAC addresses and VLAN group.
mirror			The following commands relate to port mirrors. Port mirroring is copying traffic from one or all ports to another or all ports for external analysis.

Table 28-2 Command Summary: sys sw

COMMAND			DESCRIPTION
	enable		Turns on port mirroring
	remove	<port=all portNo>	Removes mirrored port from the mirroring group.
	add	<port=all portNo> <direction=ingress egress both>	Sets the mirrored port and direction.
	disable		Turns off port mirroring.
	display		Displays current run-time port mirror settings.
	port	<port>	Sets the mirror port (the port traffic is copied to for analysis).
bw			The following commands relate to bandwidth control rules. Bandwidth control means defining a maximum allowable bandwidth for traffic flows from specified source(s) to specified destination(s).
	display		Displays current run-time bandwidth control rules.
	set	<port> <enable disable> <ingress rate[Mbps]> <egress rate[Mbps]>	Enables or disables bandwidth control of ingress and/or egress rates on individual ports.
trunk			The following commands relate to trunking. Trunking is the grouping of physical ports into one logical higher-capacity link.
	del	<id>	Delete a trunk group.
	display		Displays current run-time trunk settings.
	listview		Displays member list of trunk.
	set	<id> <# of port>	Adds ports to a trunk group.
ingress			
	set	<port> <enable disable>	Sets ingress check on a port.
	get	<port>	Gets ingress check state on a port.
	viewAll		Gets ingress check state on all ports.
learn			
	enable		Enables address learning on the switch.
	disable		Disables address learning on the switch.

Table 28-2 Command Summary: sys sw

COMMAND			DESCRIPTION
	display		Displays address learning status.
isolate			
	disable		Disables port isolation.(All connected)
	port	<port> <Port-List (in Hex)>	Sets the port-list which can connected to the specific port.
	enable		Enables port isolation.
mc			
	set	<addr> <port>...	Sets ports to a specific multicast address.
	del	<addr>	Deletes a specific multicast address.
	get	<addr>	Shows settings of the multicast address.
vlan			
	status		Displays VLAN status.
	type	<802.1q port-based>	Sets VLAN mode.
ffp	table		Shows a summary of rule settings.
	dump	<idx>	Removes the specified rule.
port		<portID> <enable disable> <auto, 10H, 10F, 100H, 100F, 1000> <FlowControl=0/1>	Port setup.
portstatus			Displays current port status and settings.
pktcnt	<port>		Displays port statistic counter.
pktcntclear	<port>		Resets port statistic counter.
policy	add	<policy name> <classifier name> [deny] [forward] [setpriority <priority>] [sendcos <priority>] [movepriortotos] [settos <tos>] [movetostoprio] [setdscp <dscp>] [sendmirror] [sendport <port>] [sendnonunicasttoport <port>] [setvid <vid>] [meter <bandwidth>] [meterout <drop setdscp forward> <dscp>]	Adds a new policy rule.
	del	<policy name>	Removes a policy rule.
	display		Displays the policy rule summary table.
	view	<policy name>	Displays detail information of a policy rule.

Table 28-2 Command Summary: sys sw

COMMAND			DESCRIPTION
vlanstack	set	[enable disable]	Enables or disables VLAN stacking on the switch.
	display		Displays whether VLAN stacking is active.
	tpid	[value (Hex)]	Sets a tag protocol identifier (TPID).
	mode	<port portNo> <mode=normal access tunnel> <spvid> <pri (0-7)>	Sets VLAN stacking.
sfp	disp		Shows sfp (mini GBIC port) connection status.
	info	<index> <offset> <len>	Shows sfp (mini GBIC port) connection information.
	diag	<index> <offset> <len>	This command is for testing.

28.2.3 exit Command

Table 28-3 Command Summary: exit

COMMAND	DESCRIPTION
exit	Ends the console or telnet session.

28.2.4 ip Commands

Table 28-4 Command Summary: ip

COMMAND			DESCRIPTION
ip			
	address	[addr]	Displays the host IP address.
	alias	<iface>	Sets an alias for the specified interface.
	aliasdis	<0 1>	Disables/enables the alias for the specified interface.
	arp	status	Displays all interfaces' IP Address Resolution Protocol status.
		add <hostid> ether <ether addr>	Add an IP address of a device with corresponding MAC address.
		drop	Removes an entry from the ARP table.
		flush	Deletes all entries from the ARP table.

Table 28-4 Command Summary: ip

COMMAND		DESCRIPTION
set	<if_name> <static dhcp> [<ip_addr>[/<bits>] [<gateway>]]	Sets the IP settings on an interface.
dns	query	Queries the DNS server to resolve domain names.
	dns server [dns IP address]	Set the IP address of a DNS server.
	stat	Shows DNS statistics.
httpd	debug [on off]	Enables or disables the HTTP debug flag.
icmp		
	status	Displays the ICMP statistics counter.
	discovery <iface> [on off]	Sets the ICMP router discovery flag.
ifconfig		Configures a network interface.
ping	<hostid>	Pings a remote host.
route		
	status	Displays the routing table.
	count	Displays the number of routing.
	add <dest addr>[/<bits>] <gateway> [<metric>]	Adds a route.
	addiface <dest addr>[/<bits>] <iface> [<metric>]	Adds an entry to the routing table for the specified interface.
	addprivate <dest addr>[/<bits>] <gateway> [<metric>]	Adds a private route.
	drop <host addr> [/<bits>]	Drops a route.
status		Displays IP statistic counters.
udp	status	Displays the UDP status.
tcp		
	ceiling [value]	Sets the TCP maximum round trip time.
	floor [value]	Sets the TCP minimum round trip time.
	irtt [value]	Sets the TCP default initial round trip time.
	kick <tcbl>	Drops the TCP connection of the specified TCP Control Block.

Table 28-4 Command Summary: ip

COMMAND		DESCRIPTION
	limit [value]	Sets a TCP output window limit.
	mss [value]	Inputs the TCP Maximum Segment Size.
	reset <tcb>	Resets the TCP connection of the specified TCP Control Block.
	rtt <tcb> <value>	Sets the round trip time for the TCP control block.
	Status [tcb] [<interval>]	Displays the TCP statistic counters.
	syndata [on off]	Turns on/off the option to send data with the SYN packet.
	trace [on off]	Turns on/off the trace for debugging.
telnet	<host> [port]	Telnets to the specified host.
tftp		TFTP to the specified host.
tredir	failcount	Sets how many times after failed.
	partner	Sets the IP address of a partner gateway.
	target	Sets the target IP address.
	timeout	Sets the time that elapses before disconnection.
	checktime	Sets the time interval between checks.
	active	Enables traffic redirect.
	save	Saves the changes.
	disp	Shows the connection settings and status.
mvid	[vid]	Sets the management VLAN ID.
	traceroute <host> [ttl] [wait] [queries]	Sends ICMP packets to trace the route of a remote host.
	igmpsnoop status	Displays the IGMP group table.
	querier	Displays the port number of the incoming port that received the latest IGMP querier.
	enable	Turns on IGMP snooping.
	disable	Turns off IGMP snooping.
dhcp <iface>	mode <none client>	Sets an interface to accept information from a DHCP server.

Table 28-4 Command Summary: ip

COMMAND			DESCRIPTION
	dhcp <iface>	status	Shows whether an interface can accept information from a DHCP server.
	dhcp <iface>	client release	Releases DHCP information such as the IP address from an interface
	dhcp <iface>	client renew	Renews the IP address on the interface.

28.2.5 ether Command

Table 28-5 Command Summary: ether

COMMAND			DESCRIPTION
config			Shows Ethernet configuration.
driver	cnt	disp <name>	Displays the channel of Ethernet driver.
	ioctl	<ch-name> <command> [arguments]	
	status	<ch-name>	Displays the channel status of Ethernet driver.
	length	<ch-name> [length]	Displays the channel length of Ethernet driver.
version			Displays the Ethernet version.

28.2.6 config Command

Table 28-6 Command Summary: config

COMMAND		DESCRIPTION
config	save	You can use the “config save” command to save 802.1Q, STP, VLAN Stacking, Cluster and IP configuration changes to non-volatile memory (Flash). These changes are effective after you restart the switch. However you cannot use “config save” for all other line command configurations. These are saved in volatile memory (DRAM), so are not effective after you restart the switch.

Chapter 29

Command Examples

This chapter describes some commands in more detail.

29.1 Commonly Used Commands Overview

These are commands that you may use frequently in configuring and maintaining your switch. See the following chapter for IEEE 802.1Q Tagged VLAN commands.

29.2 sys Commands

These are the commonly used commands that belong to the sys (system) group of commands.

29.2.1 sys log disp

Syntax:

```
sys log disp
```

This command displays the system error log. An example is shown next.

```
ES-3124> sys log disp
60 Thu Jan 1 00:00:04 1970 PINI -WARN SNMP TRAP 0: cold start
61 Thu Jan 1 00:00:04 1970 PINI INFO main: init completed
62 Thu Jan 1 00:00:09 1970 PP19 INFO adjtime task pause 1 day
Clear Error Log (y/n):
```

Figure 29-1 sys log disp Command Example

29.2.2 sys log clear

Syntax:

```
sys log clear
```

This command clears the system error log.

If you clear a log (using the `sys log clear` command), you cannot view it again.

29.2.3 sys version

Syntax:

```
sys version
```

This command shows the firmware version, system uptime and bootbase version.

An example is shown next.

```

ES-3124> sys version

ZyNOS version: V3.50(TP.0) | 10/01/2004
romRasSize: 2092220
system up time:      0:08:16 (c20c ticks)
bootbase version: V0.6 | 10/01/2004
ZyNOS CODE: RAS Sep 18 2004 17:25:37
Product Model: ES-3124
CPU chip revision: 1
CPU chip clock: 266MHz
CPU core revision: 0
ES-3124>

```

Figure 29-2 sys version Command Example

29.2.4 sys monitor status

Syntax:

```
sys monitor status
```

This command shows the hardware monitor's status.

An example is shown next.

```

ES-3124> sys monitor status
Time   VCOREA  VINRO  3.3VIN  12VIN  1.3VIN  1.25VIN  1.8VIN  MAC   CPU   PHY
F00   F01   F02   Error
-----
      538   2.528  1.216  3.328 12.038  1.328  1.232  1.824 38.5  35.0  33.0  5859  5908  5810  00000000
ES-3124>

```

Figure 29-3 sys monitor status Command Example

29.2.5 sys sw vlan1q vlan list

Syntax:

```
sys sw vlan1q vlan list <all|VID|start_VID|end_VID>
```

where

<all|VID|start_VID|end_VID>= Specify either all of the VLAN entries (all), a single VLAN ID (VID) or a range of VLAN IDs starting from a certain VID (start_VID) or a range of VLAN IDs ending at a specific VID (end_VID).

This command displays the IEEE 802.1Q tagged VLAN table. An example is shown next.

```

ES-3124> sys sw vlan1q vlan list all
No.   VID  ElapsedTime  Status  EgressPort/UntaggedPort
-----
  1)   1    2:37:35   Static  EEEEE|EEEE|EEEE|EEEE|EEEE|EEE
      UUUUU|UUUUU|UUUUU|UUUUU|UUUUU|UUU
ES-3124>

```

Figure 29-4 sys sw vlan1q vlan list Command Example

29.3 sys cluster Commands

These are the commonly used commands that belong to the “sys cluster” group of commands. Use “config save” to save these configurations.

29.3.1 sys cluster status

Syntax:

```
sys cluster status
```

This command shows whether this switch is a cluster member, cluster manager or neither and information about members in the cluster. An example is shown next.

```
ES-3124> sys cluster status
Cluster Info.
Status: 1 (0:none, 1:manager, 2:member)
Name: ES-3124
number of members: 3,          member_p=621148
number of discover devices: 0, list_p=622d08
```

Figure 29-5 sys cluster status Command Example

29.3.2 sys cluster showMember

Syntax:

```
sys cluster showMember
```

This command shows details of member switches in this cluster. An example is shown next.

```
test_mem> sys cluster showMember
No1
  ipAddr = 127.0.0.1
  mask = 255.255.0.0
  hwAddr = 00:a0:c5:05:02:34
  hostName = test_mem
  modelName=
  time = 100
  status = 4(0:Invalid, 1:waiting, 2:Active, 3:Inactive, 4:static)

No2
  ipAddr = 127.0.0.2
  mask = 255.255.0.0
  hwAddr = 00:a0:c5:05:22:11
  hostName = cm-member1
  modelName= ES-3124-1
  channel = swp05
  time = 90
  status = 2(0:Invalid, 1:waiting, 2:Active, 3:Inactive, 4:static)

No3
  ipAddr = 127.0.0.3
  mask = 255.255.0.0
  hwAddr = 00:a0:c5:e3:91:54
  hostName = ES-3124
  modelName= ES-3124-2
  channel = swp11
  time = 0
  status = 1(0:Invalid, 1:waiting, 2:Active, 3:Inactive, 4:static)
```

Figure 29-6 sys cluster showMember Command Example

29.3.3 sys cluster showCandidate

Syntax:

```
sys cluster showCandidate
```

This command shows a list of auto-discovered potential cluster members. An example is shown next.

```
test_mem> sys cluster showCandidate
NO.1
  hwAddr = 00:a0:c5:e8:e5:e3
  hostName=
  modelName=ES-3124-1
  channel =
NO.2
  hwAddr = 00:a0:c5:77:77:77
  hostName=
  modelName=ES-3124-2
  channel =
test_mem>
```

Figure 29-7 sys cluster status Command Example

29.4ip Commands

These are the commonly used commands that belong to the ip group of commands. Use “config save” to save these configurations.

29.4.1 ip ping

Syntax:

```
ip ping <hostid>
```

This command pings a remote host. An example is shown next.

```
ES-3124> ip ping 192.168.1.10
Resolving 192.168.1.10... 192.168.1.10
   sent      rcvd  rate  rtt   avg    mdev    max    min
     1         1  100    0     0      0       0     0
     2         2  100    0     0      0       0     0
     3         3  100    0     0      0       0     0
```

Figure 29-8 IP PING Command Example

29.4.2 ip route status

Syntax:

```
ip route status
```

This command displays the routing table. An example is shown next.

```
ES-3124> ip route status
Dest      FF Len Device      Gateway      Metric stat Timer Use
192.168.0.0  00 24 enet0      192.168.0.1    1  041b 0  0
192.168.1.0  00 24 swp00     192.168.1.1    1  041b 0  6
172.16.0.0   00 16 swp00     192.168.1.2    2  801b 0  0
127.0.0.0    00  8 swp00     127.0.0.1     1  041b 0  0
default      00  0 enet0     192.168.0.1    2  801b 0  0
ES-3124>
```

Figure 29-9 ip route status Command Example

29.4.3 ip arp status

Syntax:

```
ip arp status
```

This command displays all interfaces' IP Address Resolution Protocol (ARP) status. An example is shown next.

```
ES-3124> ip arp status
received 1 badtype 0 bogus addr 0 reqst in 0 replies 1 reqst out 4 bad VID 0
cache hit 29 (0%), cache miss 8366 (99%)
IP-addr      Type      Time Addr      stat iface channel
192.168.1.1  Ethernet  0    00:a0:c5:3f:91:56 43  NULL  NULL
num of arp entries= 1
ES-3124>
```

Figure 29-10 ip arp status Command Example

29.4.4 ip dhcp Commands

Syntax:

`ip dhcp swif0 mode none` (This command disables DHCP on the switch interface (swif0))

`ip dhcp swif0 status` (This command displays the DHCP status on the switch interface (swif0))

An example is shown next.

```
test_mem> ip dhcp swif0 mode none
test_mem> ip dhcp swif0 status
DHCP on iface swif0 is none
```

Figure 29-11 ip dhcp Command Examples

29.5 Enabling rstp on the Stacking Ports

Step 1. First enable RSTP

```
sys sw rstp bridge enable
```

Step 2. Then enable RSTP on the stacking port.

```
sys sw rstp port enable 25
```

```
sys sw rstp port enable 26
```

Step 3. Save the configuration

```
config save
```

Chapter 30

IEEE 802.1Q Tagged VLAN Commands

This chapter describes the IEEE 802.1Q Tagged VLAN and associated commands. Use the “config save” command to save configuration changes.

30.1 IEEE 802.1Q Tagged VLAN Overview

See the *VLAN* chapter for more information on VLANs. There are two kinds of tagging:

1. Explicit Tagging

A VLAN identifier is added to the frame header that identifies the source VLAN.

2. Implicit Tagging

The MAC (Media Access Control) number, the port or other information is used to identify the source of a VLAN frame.

The IEEE 802.1Q Tagged VLAN uses both explicit and implicit tagging.

It is important for the switch to determine what devices are VLAN-aware and VLAN-unaware so that it can decide whether to forward a tagged frame (to a VLAN-aware device) or first strip the tag from a frame and then forward it (to a VLAN-unaware device).

30.2 Filtering Databases

A filtering database stores and organizes VLAN registration information useful for switching frames to and from a switch. A filtering database consists of a static entries (Static VLAN or SVLAN table) and dynamic entries (Dynamic VLAN or DVLAN table).

30.2.1 Static Entries (SVLAN Table)

Static entry registration information is added, modified and removed by administrators only.

30.2.2 Dynamic Entries (DVLAN Table)

Dynamic entries are learned by the switch and cannot be created or updated by administrators. The switch learns this information by observing what port, source address and VLAN ID (or VID) is associated with a frame. Entries are added and deleted using GARP VLAN Registration Protocol (GVRP), where GARP is the Generic Attribute Registration Protocol.

30.3 Configuring Tagged VLAN

The following procedure shows you how to configure tagged VLAN.

Step 1. Use the IEEE 802.1Q tagged VLAN commands to configure tagged VLAN for the switch.

- Use the `sys sw vlan1q svlan setentry` command to configure a VLAN ID for each port on the switch.
- Use the `sys sw vlan1q svlan active` command when you are finished configuring the VLAN (see the last step).
- Use the `sys sw vlan1q port defaultVID` command to set the VLAN ID you created for a port to that specific port in the PVID table.
- Use the `sys sw vlan1q svlan active` command to activate the VLAN IDs.

Example:

```
ES-3124> sys sw vlan1q svlan setentry up1 2000 24 fixed tag
for newly create VLAN, please use svlan active <VID> to activate this entry

ES-3124> sys sw vlan1q port defaultVID 24 2000

ES-3124> sys sw vlan1q svlan setentry up1 2001 25 fixed untag
for newly create VLAN, please use svlan active <VID> to activate this entry

ES-3124> sys sw vlan1q port defaultVID 25 2001

ES-3124> sys sw vlan1q svlan active 2000

ES-3124> sys sw vlan1q svlan active 2001
```

Figure 30-1 Tagged VLAN Configuration and Activation Example

Step 2. Configure your management VLAN.

- Use the `sys sw vlan1q svlan setentry` command to configure a VLAN ID (VID 3 in this example) for managing the switch (the “management” or “CPU” VLAN).
- Use the `sys sw vlan1q svlan active` command to activate the new management VLAN ID.

Example:

```
ES-3124> sys sw vlan1q svlan setentry example 3 24 fixed tag

ES-3124> sys sw vlan1q svlan active 3
```

Figure 30-2 CPU VLAN Configuration and Activation Example

Step 3. Perform the procedure below to complete the VLAN setup.

- a. Telnet to the operational IP address of the switch.
- b. Use the `sys sw vlan1q svlan cpu` command to set VID 3 as the management VLAN.
- c. Use the `sys sw svlan delentry` command to remove the default VLAN ID (1).

Example:

```
ES-3124> sys sw vlan1q svlan cpu 3
ES-3124> sys sw vlan1q svlan delentry 1
```

Figure 30-3 Deleting Default VLAN Example

30.4 IEEE VLAN1Q Tagged VLAN Configuration Commands

These `sw` (switch) commands allow you to configure and monitor the IEEE 802.1Q Tagged VLAN.

30.4.1 `garp status`

Syntax:

```
sys sw garp status
```

This command shows the switch's GARP timer settings, including the join, leave and leave all timers.

An example is shown next.

```
ES-3124> sys sw garp status
GARP Timer Status :
  Join Timer = 200 msec
  Leave Timer = 600 msec
  Leave All Timer = 10000 msec
ES-3124>
```

Figure 30-4 GARP STATUS Command Example

30.4.2 `garp timer`

Syntax:

```
sys sw garp timer timer <join timer(ms)> <leave timer(ms)> <leave
all timer<ms>
```

where

- | | | |
|---|---|---|
| <code><join timer (ms)></code> | = | This sets the duration of the Join Period timer for GVRP in milliseconds. Each port has a Join Period timer. The allowed Join Time range is between 100 and 32767 milliseconds; the default is 200 milliseconds. |
| <code><leave timer(ms)></code> | = | This sets the duration of the Leave Period timer for GVRP in milliseconds. Each port has a single Leave Period timer. Leave Time must be two times larger than Join Timer; the default is 600 milliseconds. |
| <code><leave all timer<ms>=</code> | | This sets the duration of the Leave All Period timer for GVRP in milliseconds. Each port has a single Leave All Period timer. Leave All Timer must be larger than Leave Timer; the default is 10000 milliseconds. |

This command sets the switch's GARP timer settings, including the join, leave and leave all timers.

Switches join VLANs by making a declaration. A declaration is made by issuing a Join message using GARP. Declarations are withdrawn by issuing a Leave message. A Leave All message terminates all registrations. GARP timers set declaration timeout values.

The following example sets the Join Timer to 300 milliseconds, the Leave Timer to 800 milliseconds and the Leave All Timer to 11000 milliseconds.

```
ES-3124> sys sw garp timer 300 800 11000
```

Figure 30-5 garp timer Command Example

30.4.3 gvrp status

Syntax:

```
sys sw gvrp status
```

This command shows the switch's GVRP settings.

An example is shown next.

```
ES-3124> sys sw gvrp status
GVRP control block status:
  gvrpEnable = 1
  gvrpPortEnable:
    00000000000000000000000000XXXX
```

Figure 30-6 gvrp status Command Example

30.4.4 gvrp enable

Syntax:

```
sys sw gvrp enable
```

This command turns on GVRP in order to propagate VLAN information beyond the switch.

30.4.5 gvrp disable

Syntax:

```
sys sw gvrp disable
```

This command turns off GVRP so that the switch does not propagate VLAN information to other switches.

30.4.6 vlan1q port status

Syntax:

```
sys sw vlan1q port status <port>
```

This command shows information about the specified port's VLAN settings.

The following example shows the settings for port 1.

```
ES-3124> sys sw vlan1q port status 1
Port 1 VLAN Setup :
Default VLAN ID = 1
VLAN Acceptable Type = All
GVRP = Disable
VLAN Trunking = Disable
ES-3124>
```

Figure 30-7 vlan1q port status Command Example

30.4.7 vlan1q port default vid

Syntax:

```
sys sw vlan1q port defaultVID <port> <VID>
```

where

```
<port>      =      A port number
<VID>      =      The VLAN ID. Valid parameter range = [1 – 4094].
```

This command sets a default VLAN ID for all untagged packets that come in through the specified port.

The following example sets the default VID of port 1 to 2000.

```
ES-3124> sys sw vlan1q port defaultVID 1 2000
```

Figure 30-8 vlan1q port default vid Command Example

30.4.8 vlan1q port accept

Syntax:

```
sys sw vlan1q port accept <port> <all|tagged>
```

where

```
<port>      =      A port number
<all|tagged> = Specifies all Ethernet frames (tagged and untagged) or only tagged
                  Ethernet frames.
```

This command sets the specified port to accept all Ethernet frames or only those with an IEEE 802.1Q VLAN tag.

The following example sets port 2 to accept only tagged frames.

```
ES-3124> sys sw vlan1q port accept 2 tagged
```

Figure 30-9 vlan1q port accept Command Example

30.4.9 vlan1q port gvrp

Syntax:

```
sys sw vlan1q port gvrp <port> <enable|disable>
```

where

<port> = A port number
<enable|disable> = Turn GVRP on or off.

This command turns GVRP on or off for the specified port.

The following example turns off GVRP for port 2.

```
ES-3124> sys sw vlan1q port gvrp 2 disable
```

Figure 30-10 vlan1q port gvrp Command Example

30.4.10 vlan1q svlan cpu

Syntax:

```
sys sw vlan1q svlan cpu <VLAN ID>
```

where

<VID> = The VLAN ID. Valid parameter range = [1 – 4094].

This command sets the management VLAN (CPU). You can only use ports that are members of this management VLAN in order to manage the switch.

The following example sets VLAN ID 2 to be the CPU (management) VLAN.

```
ES-3124> sys sw vlan1q svlan cpu 2
```

Figure 30-11 vlan1q svlan cpu Command Example

30.4.11 vlan1q svlan setentry

Syntax:

```
sys sw vlan1q svlan setentry <name> <VID> <PORT> <ADCTL> <TAGCTL>
```

where

<name> = A name to identify the SVLAN entry.
<VID> = The VLAN ID [1 – 4094].
<PORT> = This is the switch port number.

- `<ADCTL>` = This is the registrar administration control flag.
Valid parameters = [fixed, forbidden, normal].
- Enter `fixed` to register a `<port #>` to the static VLAN table with `<vid>`.
Enter `normal` to confirm registration of the `<port #>` to the static VLAN table with `<vid>`.
Enter `forbidden` to block a `<port #>` from joining the static VLAN table with `<vid>`.
- `<TAGCTL>` = This is the tag control flag. Valid parameters = [tag|untag].
- Enter `tag` to tag outgoing frames.
Enter `untag` to send outgoing frames without a tag.

This command adds or modifies an entry in the static VLAN table. Display your configuration by using the `sys sw vlanlq svlan list` command. An example of a configuration is shown next.

Modify a Static VLAN Table Example

The following is an example of how to modify a static VLAN table.

```
1.      ES-3124> sys sw vlanlq svlan setentry 2000 1 fixed tag
2.      ES-3124> sys sw vlanlq svlan setentry 2001 2 fixed tag
```

Figure 30-12 Modifying the Static VLAN Example

Forwarding Process Example

Tagged Frames

- Step 1.** First the switch checks the VLAN ID (VID) of tagged frames or assigns temporary VIDs to untagged frames (see *Section 30.4.7*).
- Step 2.** The switch then checks the VID in a frame's tag against the SVLAN table.
- Step 3.** The switch notes what the SVLAN table says (that is, the SVLAN tells the switch whether or not to forward a frame and if the forwarded frames should have tags).
- Step 4.** Then the switch applies the port filter to finish the forwarding decision. This means that frames may be dropped even if the SVLAN says to forward them. Frames might also be dropped if they are sent to a CPE (customer premises equipment) DSL device that does not accept tagged frames.

Untagged Frames

- Step 1.** An untagged frame comes in from the LAN.
- Step 2.** The switch checks the PVID table and assigns a temporary VID of 1.
- Step 3.** The switch ignores the port from which the frame came, because the switch does not send a frame to the port from which it came. The switch also does not forward frames to "forbidden" ports.
- Step 4.** If after looking at the SVLAN, the switch does not have any ports to which it will send the frame, it won't check the port filter.

30.4.12 vlan1q svlan delentry

Syntax:

```
sys sw vlan1q svlan delentry <VID>
```

where

<VID> = The VLAN ID [1 – 4094].

This command deletes the specified VLAN ID entry from the static VLAN table

The following example deletes entry 2 in the static VLAN table.

```
ES-3124> sys sw vlan1q svlan delentry 2
```

Figure 30-13 vlan1q svlan delentry Command Example

30.5vlan1q svlan active

Syntax:

```
sys sw vlan1q svlan active <VID>
```

This command enables the specified VLAN ID in the SVLAN (Static VLAN) table.

30.6vlan1q svlan inactive

Syntax:

```
sys sw vlan1q svlan inactive <VID>
```

This command disables the specified VLAN ID in the SVLAN (Static VLAN) table.

30.7vlan1q svlan list

Syntax:

```
sys sw vlan1q svlan list
```

This command shows the IEEE 802.1Q Tagged SVLAN (Static VLAN) table.

An example is shown next.

For the AdCtl section of the last column, “-“ is a port set to normal, “X” is a forbidden port and “F” is a fixed port.

For the TagCtl section of the last column, “T“ is a tagged port, “U” is an untagged port.

```

ES-3124> sys sw vlan1q svlan list
802.1Q VLAN Static Entry:
idx. Name          VID Active  AdCtl / TagCtl
-----
0             1      1 active  FFFFFFFFFFFFFFFFFFFFFFFFFF
              1      1 active  UUUUUUUUUUUUUUUUUUUUUUUUU
1             upl 2000 active  -----F----
              2      1 active  TTTTTTTTTTTTTTTTTTTTTTTTTT
2             upl 2001 active  -----F----
              3      1 active  TTTTTTTTTTTTTTTTTTTTTUUTT
3             example 3 active  -----F----
              4      1 active  TTTTTTTTTTTTTTTTTTTTTTTT
ES-3124>

```

Figure 30-14 vlan1q svlan list Command Example

30.8 vlan1q vlan list

Syntax:

```
sys sw vlan1q vlan list <all|VID|start_VID|end_VID>
```

where

<all|VID|start_VID|end_VID>= Specify either all of the VLAN entries (all), a single VLAN ID (VID) or a range of VLAN IDs starting from a certain VID (start_VID) or a range of VLAN IDs ending at a specific VID (end_VID).

This command shows the current IEEE 802.1Q Tagged VLAN table or a specific part of it.

An example is shown next.

For the EgressPort section of the last column, “E” is an egress port for this VLAN, “-“ is not an egress port for this VLAN.

The UntaggedPort section of the last column displays “-“ for a tagged port and “U” for an untagged port.

```

ES-3124> sys sw vlan1q vlan list all
No.   VID  ElapsedTime  Status  EgressPort/UntaggedPort
-----
1)    1    1:04:56  Static  EEEEE|EEEE|EEEE|EEEE|EEEE|EEE
      2)    3    0:35:13  Static  UUUUU|UUUU|UUUU|UUUU|UUUU|UUU
      3) 2000    0:49:17  Static  -----|-----|-----|---E|---
      4) 2001    0:41:21  Static  -----|-----|-----|---E|---
      5)    4    0:00:00  Static  -----|-----|-----|---U|---
ES-3124>

```

Figure 30-15 vlan1q svlan list Command Example

30.8.1 vlan1q vlan status

Syntax:

```
sys sw vlan1q vlan status
```

This command displays the current configuration of the IEEE 802.1Q VLAN.

See the following example shows the default VLAN settings. The default VLAN allows all ports to connect to each other and sets them to send untagged packets.

```
ES-3124> sys sw vlan1q status
802.1Q VLAN Setup :
  GVRP = Disable
  Managment VLAN ID = 1
ES-3124>
```

Figure 30-16 vlan1q vlan status Command Example

Part VIII

Appendices and Index

This part contains appendices of advanced background feature information and an Index.

A Product Specifications

These are the ES-3124 product specifications.

Chart 1 General Product Specifications

Standards	IEEE802.3 10BASE-T Ethernet (twisted-pair copper) IEEE802.3u 100BASE-TX Fast Ethernet (twisted-pair copper) ANSI/IEEE802.3 Auto-negotiation IEEE802.3x Flow Control IEEE802.1p Priority Queues IEEE802.1q VLAN IEEE802.1d Spanning Tree IEEE 802.1x Authentication IEEE 802.3 ad Link Aggregation IEEE 802.1w Rapid reconfiguration
Protocol	CSMA/CD
Interface	24 10/100BASE-T Ethernet ports Two RJ-45 Gigabit/mini GBIC combo ports for uplink Two Gigabit ports for stacking One console port One management port
Data Transfer Rate	Ethernet: 10Mbps (half duplex/full duplex) Fast Ethernet: 100Mbps (half duplex/full duplex) Gigabit: 1000Mbps (full duplex)
Network Cables	10BASE-T: 2-pair Unshielded Twisted Pair (UTP) Cat.3, 4, 5 (100 meters) EIA/TIA-586 100-ohm Shielded Twisted Pair (STP) (100 meters) 100BASE-TX, 1000BASE-T: UTP Cat.5 (100 m max.) EIA/TIA-568 100-ohm STP (100 m max.)
Full/Half Duplex	Full/half duplex for 10/100Mbps speeds Full duplex only for Gigabit speeds
Media Interface Exchange	All ports are auto-crossover (auto-MDI-X) and auto-negotiating.

Chart 2 Performance and Management Specifications

Back plane	12.8 Gbps
Packet Forwarding Rate	14880 PPS for 10BASE-T 148800 PPS for 100BASE-TX
Switching Method	Store-and-forward
MAC Address Table	16 K entries
Data Buffer	32MB
VLAN	IEEE 802.1Q tag-based VLAN, 4094 Max
IEEE 802.1p Priority Queues	Eight queues
Port Link Aggregation	IEEE802.3ad dynamic port trunking
Port Security	Static MAC address filtering MAC address learning limit
Multicasting	Support IGMP snooping
Broadcast Storm	Support broadcast storm control
Port Mirroring	All Ethernet, Gigabit, stacking and uplink ports support port mirroring
Management	Web-based management Console Telnet SNMP
Management Security	User ID/Password for Telnet and Web-based management authentication Up to four administrators allowed
MIBs	SNMP MIB II (RFC 1213) RFC 1157 SNMP v1 SNMPv2, SNMPv2c or later version, compliant with RFC 2011 SNMPv2 MIB for IP, RFC 2012 SNMPv2 MIB for TCP, RFC 2013 SNMPv2 MIB for UDP RFC 1643 Ethernet MIBs RFC 1493 Bridge MIBs RFC 1155 SMI RFC 1757 RMON RFC 2674 SNMPv2, SNMPv2c

Chart 3 Physical and Environmental Specifications

Weight	Main switch: 3.6Kg
LED	Main switch: BPS, PWR, SYS, ALM, LINK/ACT, FDX Per Gigabit Port: LNK/ACT, FDX Per mini GBIC Slot: LNK, ACT Per Management Port: 10, 100
Dimensions	Main switch: 438(W) x 270(D) x 44.45(H) mm (17.2(W) x 10.6(D) x 1.75(H) inches), 19-inch rack-mount width, 1U height
Power Supply (AC Unit)	100 - 240VAC 50/60Hz 1.5A max internal universal power supply
Power Consumption	60W maximum
Fuse Rating	T2A250VAC Caution: For continued protection against risk of fire, replace only with the same type and fuse rating.
Operating Temperature	0°C ~45°C (32°F to 113°F)
Storage Temperature	-25°C ~70°C
Operational Humidity	10% to 90% (Non-condensing)
Safety	UL 60950-1 CSA 60950-1 EN60950-1 IEC60950-1
EMC	FCC Part 15 (Class A) CE EMC (Class A)

B Index

I

10/100M Auto-crossover Ethernet 3-2

8

802.1Q VLAN Type..... 6-7

802.3ad..... 1-3

A

Acceptable Frame Type 7-6

Access Control 17-1

Address Learning 16-3

Aging Time 6-7

Airflow 3-6

All Connected..... 7-13

ALM..... 3-7

authenticationFailure..... 17-3

Auto-crossover 3-3

B

Back Panel..... 3-6

Back plane..... A-2

Backup Configuration 23-2

Backup Power Supply (BPS) 3-5

Backup Power Supply Connector 3-6

Bandwidth Control 1-3

Bandwidth Control Setup..... 11-1

Basic Setting 6-1

Bridge ID..... 10-3

Bridge MIBs RFC 1493 1-2

Bridge Priority..... 10-6

Bridge Protocol Data Units (BPDUs) 10-1

Broadcast storm control 1-3

C

Canonical Format Indicator..... 7-1

CE..... iv

Index

Certification iv

CFI *See* Canonical Format Indicator

class A iv

Classifier

Ethernet Type..... 19-3

Packet Format..... 19-3

CLI Command VII

Configure tagged VLAN example 30-2

Getting help..... 28-2

Static VLAN Table example..... 30-7

sys Commands 28-2

Cold Start 17-3

Command

exit command..... 28-14

ip commands 28-14

Summary 28-2

Command

Command conventions..... 28-1

config command..... 28-17

Forwarding Process Example..... 30-7

IEEE 802.1Q Tagged VLAN commands example

..... 30-1

Syntax conventions 28-2

sys sw Commands 28-6

Command Line Interface VII

Accessing 28-1

Introduction..... 28-1

config Command..... 28-17

config save 3-10, 28-1, 28-7, 28-8, 28-17

Configuring STP 10-4

Console Port..... 1-2, 3-2

Contact Person's Name 6-4

Contacting Customer Support..... v

Copyright ii

Cost to Bridge 10-4

Customer Support v

D

Data Buffer..... A-2

Daytime (RFC 867)..... 6-5

Default Settings

Ethernet	3-2
Diagnostic.....	24-1
Differentiated Services	20-1
DiffServ	20-1
DiffServ Code Points.....	20-1
Dimensions.....	A-3
Disclaimer	ii
Double-tagged Frames	21-1
DSCPs	20-1
Duplex	6-12
DVLAN Table.....	30-1
Dynamic Link Aggregation.....	14-1

E

egress port	7-13
EMC	A-3
Error Packet.....	5-5
Ethernet Address	6-2
Ethernet MIBs RFC 1643.....	1-2
Ethernet Port Test.....	24-2
Exposed IES-2000 Power Wire.....	3-1

F

Fans	1-2
FCC Rules	iv
FCC Warning	iv
Federal Communications Commission (FCC) Interference Statement.....	iv
File Transfer using FTP.....	23-4
command example.....	23-4
GUI-based	23-5
procedure.....	23-4
restrictions over WAN.....	23-5
Filename Conventions.....	23-4
Filter Setup	9-1
Filtering	9-1
View rules.....	9-2
Filtering database	<i>See</i> MAC Table
Filtering Databases.....	30-1
Firmware Upgrade.....	23-1
Flow control	3-10
Flow Control	6-12
Forwarding Delay.....	10-4, 10-6

Firmware version	6-2
Front Panel	3-1
Front Panel LEDs.....	3-6
FTP.....	23-4

G

GARP	30-1. <i>See</i> Generic Attribute Registration Protocol
garp status.....	30-3
GARP Status Command.....	30-3
GARP Terminology	7-2
garp timer	30-3
GARP Timer	6-8
General Setup	6-1, 6-3, 6-4
Generic Attribute Registration Protocol.....	7-2
Get Community	17-4
GetNext	17-3
Giant.....	5-5
Gigabit Ports.....	3-2
GVRP	7-6, 30-1
GVRP (GARP VLAN Registration Protocol). 7-2, 7-6	
gvrp disable	30-4
gvrp enable	30-4
gvrp status	30-4

H

Hardware Monitor	
Fans	6-3
Temperature	6-2
Volatge	6-3
Hello Time	10-3, 10-6
Help	4-9
How STP Works	10-1
HTML help.....	xviii
HTTP	19-5

I

IEEE 802.1p	6-8
IEEE 802.1Q	<i>See</i> Tagged VLAN
IEEE 802.1Q Tagged VLAN	30-1
IEEE 802.1x	15-1
IGMP snooping	1-3

IGMP Snooping	6-6	Management Information Base (MIB).....	17-2
Ingress Check.....	7-6	Management Port.....	3-5
Ingress filtering.....	7-2	Management VLAN ID	6-10
Installation		Max Age.....	10-2, 10-3, 10-6
Desktop	2-1	Media Access Control.....	6-2
Rack-Mounted.....	2-2	Media Interface Exchange	A-1
IP Address.....	6-10	MGNT port	3-5
ip arp status	29-5	MIBs	A-2
ip Commands		Mini GBIC Modules	1-1
examples.....	29-4	Mini GBIC slots.....	3-2
summary.....	28-14	Monitor port.....	13-1
ip ping	29-5	Mounting Brackets.....	2-2
IP Ports.....	19-5	Multi-tenant unit (MTU).....	xviii
IP Protocols.....	1-2		
ip route status	29-5		
IP Setup.....	6-1, 6-9		
IP Subnet Mask	6-10		
<hr/>			
J		N	
Join Timer	6-8	Naming Conventions.....	xix
<hr/>			
L		Navigation Panel Links.....	4-4
LACP		Network Applications	
Timeout.....	14-5	Bridging	1-4
LACP Status.....	14-2	Collapsed Backbone.....	1-3
Leave All Timer.....	6-8	High Performance Switched Workgroup.....	1-5
Leave Timer	6-8	VLAN Application.....	1-5
LED Descriptions.....	3-6	VLAN Server	1-6
Link Aggregate Control Protocol (LACP),.....	14-1	VLAN Workgroup	1-5
Link Aggregation ID	14-1	Network Cables.....	A-1
Link Aggregation Setup	14-3	NTP (RFC-1305).....	6-5
linkDown.....	17-3	<hr/>	
Location	6-4	O	
Login Accounts	17-4	Operating Temperature	A-3
<hr/>			
M		Operational Humidity	A-3
MAC.....	6-2	Out of Profile Action.....	20-4
MAC address.....	6-2	Out-of-profile traffic	20-3
MAC address learning.....	1-3, 6-7, 8-1	<hr/>	
MAC Address Learning	6-7	P	
MAC Address Table	A-2	Packet Forwarding Rate.....	A-2
Maintenance	23-1	Password	
<hr/>			
Index		Default.....	4-1
		Path cost.....	10-1
		Ping	24-2
		Policy	
		Actions	20-3
		Metering.....	20-3
		<hr/>	
			B-3

POP (point-of-presence	xviii
POP3.....	19-5
Port Based VLAN Type	6-7
Port Details	5-2, 5-3
Port Isolation	7-6, 7-13
Port Mirroring	1-2, 13-1, 28-11
Port Setup	6-10, 6-11
Port Statistics.....	<i>See</i> Port Details
Port Status	5-1. <i>See</i> Port Details
Port Link Aggregation.....	1-3
Port VID	7-2
Default for all ports	7-1
Port-based VLANs	7-10
Configure.....	7-10
Power Connector	3-6
Power Consumption	A-3
Power Supply	A-3
Priority.....	6-8
Priority Level.....	6-8
Priority Queue Assignment	6-8, 6-12
Product specifications.....	A-1
PWR	3-7

Q

Quality of Service.....	1-3
-------------------------	-----

R

RADIUS (Remote Authentication Dial-In User Service).....	15-1
RADIUS Setup	15-2
ras	23-4
Ras	23-4
Rear Panel	3-5
Rear Panel Connections	
Rear Panel.....	3-6
Reauthentication.....	15-4
Related Documentation	xviii
Remote Management.....	17-6
repair.....	iii
Resetting the Switch.....	4-6
Restore Configuration	23-2
RMON RFC 1757	1-2
Rom-0.....	23-4

Root bridge.....	10-1
Rubber Feet	2-1
Runt.....	5-5
Rx KB/s.....	5-2, 5-4
Rx Packet	5-4
RxPkts	5-2, 5-4

S

Safety.....	A-3
Safety Warnings	3-1
Scenarios	2-1
Screen Overview	4-5
Secured Client	23-5
Server Port.....	17-6
Service.....	iii
Service Access Control	17-6
Service Provider Tag Protocol Identifier.....	21-3
Service Provider's Network	21-1
Set Community.....	17-4
Shared Secret.....	15-2
Simple Network Management Protocol	17-2
Small Form-factor Pluggable (SFP).....	3-3
SMI RFC 1155	1-2
SNMP	17-2
Configuring	17-3
Trap	17-4
Get	17-3
Manager.....	17-2
MIBs.....	17-3
supported versions.....	17-2
Trap	17-3
SNMP Commands.....	17-3
SNMP MIB II (RFC 1213).....	1-2
SNMP Traps.....	17-3
SNMP v1 RFC 1157	1-2
SNMPv2, SNMPv2c RFC 2674.....	1-2
SP TPID	21-3
Spanning Tree Protocol	10-1
SPN	21-1
Stacking.....	1-1
1-2	
Stacking Scenarios	3-8
standard browser	4-1
Standards	A-1

Static MAC Forward Setup.....	8-1	Tagged VLAN.....	7-1
Static MAC Forwarding.....	8-1	GARP.....	7-2
Static Route		GVRP.....	7-2
Setup.....	22-1	Membership Registration.....	7-1
Summary table.....	22-2	Taiwanese BSMI A Warning.....	iv
Static VLAN.....	7-6	TCI.....	<i>See</i> Tag Control Information
Control.....	7-8	TCP/UDP protocol port numbers.....	19-3, 19-4
Summary Table.....	7-8	Terminal emulation.....	3-2
Tagging	7-8	Terminal Emulation.....	3-2, 28-1
Status.....	5-1	Time (RFC-868).....	6-5
STP.....	<i>See</i> Spanning Tree Protocol	Time server protocol supported.....	6-5
STP (Spanning Tree Protocol).....	1-3	TPID.....	<i>See</i> Tag Protocol Identifier
STP Path Costs.....	10-1	Trademarks.....	ii
STP Port States.....	10-2	Transceiver Installation.....	3-3
STP Status.....	10-2	Transceiver MultiSource Agreement (MSA).....	3-3
STP Terminology.....	10-1	Transceiver Removal.....	3-4
SVLAN Table.....	30-1	Trap.....	17-4
Switch Lockout.....	4-6	Trunk Setup.....	14-5
Switch Setup.....	6-6, 7-3	trusted computers.....	17-7
Switching Method.....	A-2	TX Collision.....	5-4
Synchronized Ports.....	14-3	Tx KB/s.....	5-2, 5-4
Syntax Conventions.....	xviii	Tx Packet.....	5-4
SYS.....	3-7	TxPkts.....	5-2, 5-4
sys Commands			
examples.....	29-1		
Summary.....	28-2		
sys log clear.....	29-1		
sys log disp.....	29-1		
sys monitor status.....	29-2		
sys sw commands			
summary.....	28-6		
sys sw vlan1q vlan list.....	29-2		
sys version.....	29-1		
System Information.....	5-1, 6-1		
System Log.....	24-1		
System Monitoring.....	1-2		
System Name.....	6-4		
System Priority.....	14-5		
System Statistics.....	5-1		
System up Time.....	5-2		
<hr/>			
T			
Tag Control Information.....	7-1		
Tag Protocol Identifier.....	7-1		
<hr/>			
		U	
		Up Time.....	5-2
		Uplink Modules.....	1-1
		Uplink Scenario.....	3-9
		Username	
		Default.....	4-1
<hr/>			
		V	
		ventilation.....	2-1
		ventilation holes.....	2-1
		VID.....	7-4, 7-6, 21-3. <i>See</i> VLAN Identifier
		VLAN.....	7-1
		Explicit Tagging.....	30-1
		Forwarding.....	7-1
		ID (VID).....	30-1
		Implicit Tagging.....	30-1
		Introduction.....	6-6
		Port-based.....	7-10
		Priority frame.....	7-1

Registration Information 30-1

 Tagged VLAN 7-1

VLAN Administrative Control 7-2

VLAN Group 7-8

VLAN ID 6-10, 7-1

 maximum number of 7-1

VLAN Identifier 7-1

VLAN Port Settings 7-5

VLAN Stacking 21-1

VLAN Status 7-4

VLAN Tag Control 7-2

VLAN Type 6-7, 7-3

vlan1q port accept 30-5

vlan1q port default vid 30-5

vlan1q port gvrp 30-6

vlan1q port status 30-4

vlan1q svlan active 30-8

vlan1q svlan cpu 30-6

vlan1q svlan delentry 30-8

vlan1q svlan inactive 30-8

vlan1q svlan list 30-8

vlan1q svlan setentry 30-6

vlan1q vlan list 30-9

VT100 3-2, 28-1

W

WarmStart 17-3

Warnings 3-1

Web Configurator 4-1

 Logging out 4-8

 Login 4-1

 Online help 4-9

 Recommended browsers 4-1

X

XMODEM upload 4-7

Z

ZyNOS (ZyXEL Network Operating System) 23-4

ZyNOS Firmware version 6-2

ZyXEL Limited Warranty iii

 Note iii

ZyXEL Web Site xviii